

# NuclearNews

55th Annual Products, Services & Suppliers Directory



## Buyers Guide 2024

Connecting the worldwide nuclear community

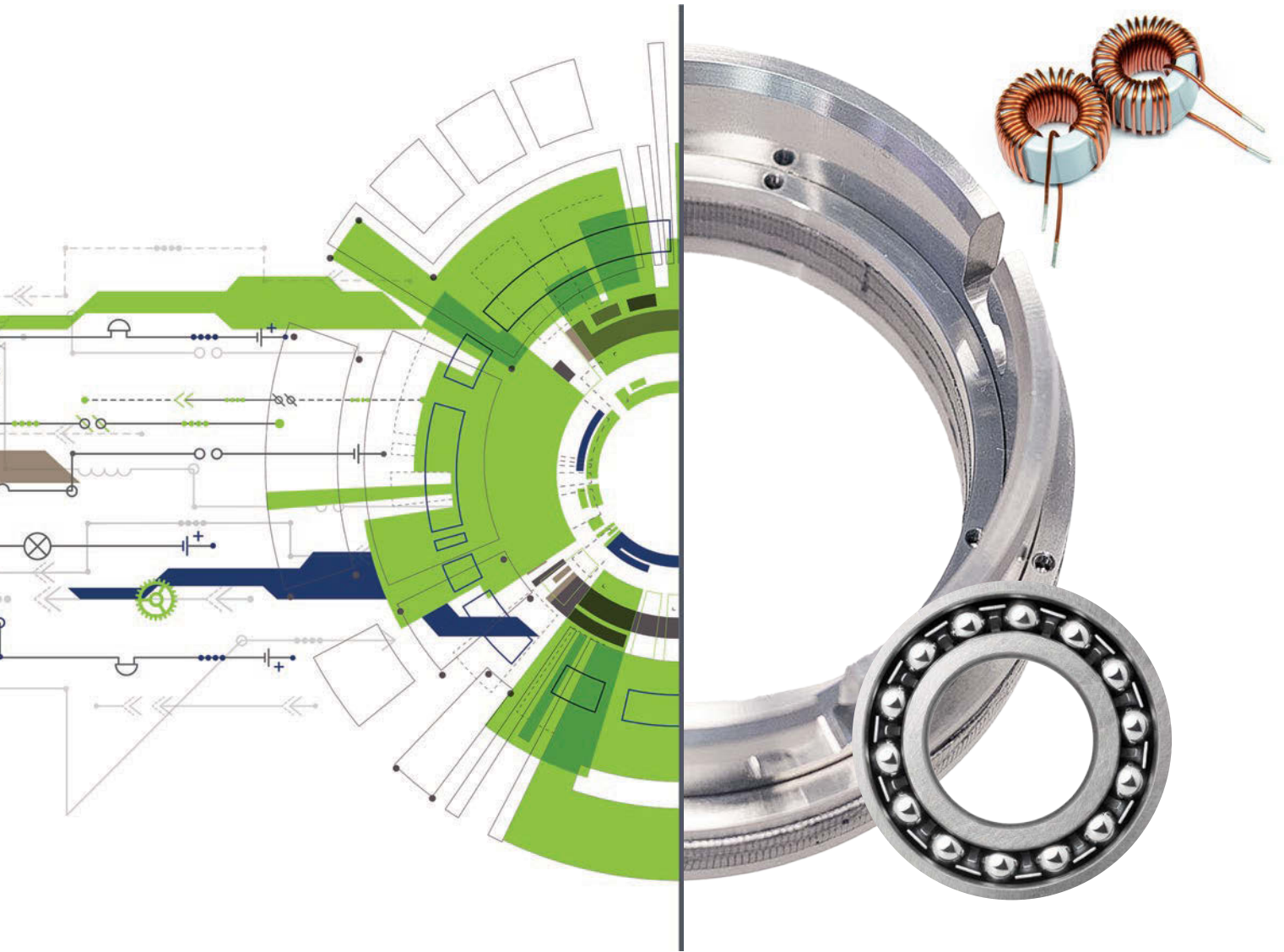

# Components & Capabilities You Can Count On

Offering round-the-clock support, the trusted experts from Westinghouse Parts provide services and parts to **100% of the world's nuclear plants.** Westinghouse provides high-quality nuclear-qualified solutions and products that meet the original design and qualification of your plant.

To learn more about our advanced solutions and services, get in touch with a parts specialist today at [www.westinghousenuclear.com/wpb](http://www.westinghousenuclear.com/wpb)



# EXCEL

## SERVICES CORPORATION

FOR FOUR DECADES

A TRUSTED PARTNER FOR THE CURRENT FLEET & NEW NUCLEAR BUILDS  
ENABLING CLIENTS TO ENHANCE SAFETY & SECURITY,  
IMPROVE EFFICIENCY & PERFORMANCE, AND REDUCE OPERATING COSTS

### New Nuclear Build Support

- Supporting Governments, Ministries, Regulatory Authorities, Owner/Operators, and the Supply Chain in all new nuclear build required activities, including but not limited to:
  - Establish New Nuclear Infrastructure
  - Establish New Nuclear Regulatory Authority
  - Existing Nuclear Regulatory Support for New Nuclear Reactor Technology(ies)
  - Harmonize & Standardize Regulatory Approach
  - Nuclear Technology Selection (all sizes)
  - Nuclear Feasibility Studies & Nuclear Program Strategic plans
  - Site Selection, Siting Approval, and Environmental Assessments
  - And others

### 40 Years of Firsts

- Developed & and Maintain ITS NUREGs
  - Eighty-two ITS conversions
- 24 Month Fuel Cycle Extension (GL 91-04 )
  - Forty-two 24 MFC extensions
- Unparalleled owners' groups support
  - 600+ TSTF Travelers
  - Multiple generic issue resolutions

### Current Fleet Support

- ITS Conversions/Upgrades
- 24 Month Fuel Cycle (MFC) Extensions
- Extended Power Uprate
- License Renewal / Subsequent License Renewal application and implementation
- Critical Infrastructure Protection
- Event Response
- Workforce Enhancement/Training/ Knowledge Management
- General Licensing

### New Directions

- Partnered with Pelican Energy to provide equity funding for future acquisitions, facilitating EXCEL's growth and expansion of services in the U.S. and globally
- Acquired IEPSON Consulting Enterprises to expand LR/SLR capabilities
- Continuing to expand service offerings and service locations in U.S. and globally

EXCEL Services Corporation  
11921 Rockville Pike, Ste. 100, Rockville, MD 20852  
301-984-4400 [www.excelservices.com](http://www.excelservices.com)

# NuclearNews

Mid-April 2024  
Volume 67, Number 5

## Buyers Guide 2024

- 4 How to use the 2024 *Nuclear News* Buyers Guide effectively
- 8 Index to Advertisers
- 16 Index to Categories
- 31 Nuclear Products, Materials & Services Directory
- 128 ANS Organization Members Directory of Suppliers
- 129 Part I—Companies located in the United States
- 155 Part II—Companies located outside the United States

The directory sections of the Buyers Guide are kept current via annual company listing verification/update requests each January–March and new company listings that are submitted throughout the year. A live version of this directory can be found online at [ans.org/news/bg/](https://ans.org/news/bg/) and is updated year-round.

Individual copies of *Nuclear News* Buyers Guide 2024 are available by ordering from the American Nuclear Society at [ans.org/store/browse-buyersguide/](https://ans.org/store/browse-buyersguide/). List price is \$145 (add \$16 per copy to cover overseas mailings). For information on ordering more than one copy, contact ANS at 800/323-3044 or [askanything@ans.org](mailto:askanything@ans.org).

Visit the online  
Buyers Guide



### Editorial

Director of Publications John Fabian

Publisher/Editor-in-Chief Rick Michal

#### Staff Writers

Susan Gallier, Tim Gregoire,  
Dot Schneider, Amelia Tiemann

Contributors A. J. Smuskiewicz, Michael McQueen

Copy Editors David Strutz, Mary Tong

Graphic Design Specialist Chris Salvato

Contributing Designers Jay Bogardus, Lisa Dagley

### Advertising & Circulation

Director of Advertising and Sponsorships Jeff Mosses

Advertising Production Specialist Erica McGowan

### Editorial Advisory Committee

Jess C. Gehin, John G. Gilligan,  
Lawrence E. (Larry) Boing, Dale Vines

### ANS Officers

President Kenneth Petersen

Vice President/President-Elect Lisa Marshall

Treasurer Harsh Desai

Chairman, ANS Publications Steering Committee

Xiaodong Sun

### Administrative

Executive Director/Chief Executive Officer

Craig Piercy

### ANS Headquarters

#### General Information

[askanything@ans.org](mailto:askanything@ans.org)

708/352-6611 | Fax 708/579-8314 | [ans.org](https://ans.org)

#### Nuclear News Advertising

708/579-8225 | 708/579-8226

[ans.org/advertising/](https://ans.org/advertising/) | [advertising@ans.org](mailto:advertising@ans.org)

#### Nuclear News Editorial

708/579-8216 | [nucnews@ans.org](mailto:nucnews@ans.org) | [ans.org/nn](https://ans.org/nn)

*Nuclear News* (ISSN: 0029-5574), Volume 67, Number 5. Published monthly (except during the month of April when issued twice monthly) by the American Nuclear Society, Incorporated, with business, executive, and editorial offices at 1111 Pasquinelli Drive, Suite 350, Westmont, Illinois 60559; telephone 708/352-6611. Subscription rate for 2024 is \$825, which includes complimentary electronic access, 1959 to current issue; for subscriptions outside North America, add \$89 for shipping and handling. Alternatively, subscription rate is \$720 for Electronic Access Only, 1959 to current issue. Single copy price (regular monthly issues) is \$52; add \$12 for postage and handling if being shipped to address outside North America. Single copy price for annual mid-April Buyers Guide is \$145; add \$16 for postage and handling if being shipped to address outside North America. Individual ANS members receive *Nuclear News* as part of membership. Replacement copies may be obtained at the single copy price, as long as copies are available. Inquiries about the distribution and delivery of *Nuclear News* and requests for changes of address should be directed to the American Nuclear Society. Allow six weeks for a change to become effective. POSTMASTER: Send change of address orders to *Nuclear News*, American Nuclear Society, 1111 Pasquinelli Drive, Suite 350, Westmont, Illinois 60559. *Nuclear News* is printed in New Richmond, Wis. 54017, by St. Croix Press, Inc. Nonprofit periodicals postage paid at Westmont, Illinois, and at additional mailing offices. Copyright © 2024 by the American Nuclear Society, Inc. Trademark registered in USA and Canada. Opinions expressed in this publication by the authors are their own and do not necessarily reflect the opinions of the editors, the American Nuclear Society, or the organizations with which the authors are affiliated, nor should publication of author viewpoints or identification of materials or products be construed as endorsement by this publication or by the Society.

Texts of most *Nuclear News* articles are available on the LexisNexis database, from Mead Data Corporation.

 **American Nuclear Society**

#NUCLEARISHERE

Nuclear energy found a home at ORNL eighty years ago and never left. One-of-a-kind user facilities, strategic partnerships, and international expertise—they all live here. The view from the ridges of East Tennessee stretches from the foundations of nuclear energy to the most advanced reactor designs on the planet—and beyond.

The future of nuclear energy calls ORNL home. So should you.

# NUCLEAR

TODAY. TOMORROW. ALWAYS.

- Reactor Design and Optimization
- Materials and Fuels Innovation
- Nuclear Nonproliferation
- Fuel Cycle Integration
- Facility Siting, Construction, and Licensing
- Radioisotope Production and Application
- Safety, Safeguards, and Security

For additional information,  
contact [nuclearrecruiting@ornl.gov](mailto:nuclearrecruiting@ornl.gov)  
or visit [jobs.ornl.gov](http://jobs.ornl.gov).

ORNL is an equal-opportunity employer. All qualified candidates, including protected veterans and individuals with disabilities, are encouraged to apply. ORNL is an E-verify employer.

OAK RIDGE  
National Laboratory



U.S. DEPARTMENT OF  
ENERGY



# How to use the 2024 *Nuclear News* Buyers Guide effectively

## REFERENCE INDEXES

### Index to Advertisers

This listing (pp. 8–14) gives in alphabetical order all of the companies advertising in this year’s Buyers Guide, the page number(s) on which their ad(s) can be found, and current contact information.

### Index to Categories

This listing (pp. 16–29) gives in alphabetical order all of the categories that are presented in Section I (“Nuclear Products, Materials & Services Directory”). Page locations are shown in **bold face**; category code numbers in light face. Extensive cross references are included *only* in this index to help users find categories of interest.

## SECTION I

### Nuclear Products, Materials & Services Directory

This section (pp. 31–127), lists in alphabetical order the various categories of products, materials, and services that are used in the nuclear industry. There are 476 categories, each with the names of suppliers and their locations.

Several product categories are further divided into subcategories, which are identified by code letters. In a given category, the code letters accompanying suppliers’ names indicate which subcategories are offered.

Please refer to the Index of Categories (pp. 16–29) for extensive cross-references.

Companies advertising in this year’s Buyers Guide are identified by a diamond (◆) preceding their names, and are **highlighted in blue** in the category near which their advertisement appears. Consult the Index to Advertisers (pp. 8–14) for location information.

## SECTION II

### Directory of Suppliers

This section (pp. 129–160) lists in alphabetical order the suppliers represented in Section I, divided into two parts: suppliers located in the United States (from page 129); and suppliers located outside the United States (from page 155).

Each listing provides the supplier’s name, location, contact information, and N Stamp information, where applicable. Also included are the code numbers designating the product, material, and service categories under which each company is listed in Section I. To translate code numbers into category names, refer to the Index to Categories (pp. 16–29).

Advertisers in this year’s Buyers Guide are **highlighted in yellow**. A separate line shows the page number of the advertisement (see also the Index to Advertisers, pp. 8–14).

## ONLINE DATABASE

Visit the online Buyers Guide



*Nuclear Newswire* readers now have access to a fully searchable database that will include the following:

■ **Product listings**—Categories of products, materials, and services with a listing of suppliers and their locations for each.

■ **Directory of Suppliers**—An alphabetical listing of suppliers by country that includes the supplier’s name, location, contact personnel and information, and nuclear certification information, where applicable.

See the *Nuclear News* Buyers Guide online at [ans.org/news/bg/](https://ans.org/news/bg/)



## CONTACT

-  16 Bank Street  
Peekskill, NY 10566
-  914.736.7100
-  info@wmginc.com
-  www.wmginc.com

## Recognized **Leader** in Radwaste Management



Helping you succeed for over 4 decades

WMG is celebrating its 45th anniversary of providing sustainable, innovative services for radioactive materials and waste management professionals. We are a leader in nuclear and radiological engineering, offering a range of specialized services to address the diverse needs of the commercial nuclear industry. In addition to performing the functions listed below, we also offer advice and peer-review in a best-practices capacity. Our services and review capabilities include:

### DOSE ASSESSMENTS

Our Radiological Engineering expertise encompasses comprehensive assessments, including Off-Site Dose, Internal Dose, Site Boundary Dose, System/Equipment Shielding, Emergency Planning, and Dose-to-Public evaluations.

### SEGMENTATION PLANNING

WMG are the go-to experts for Segmentation Planning, collaborating with clients to optimize the planning process for component management and packaging. Irradiated hardware, reactor internals, steam generator and other large components.

### WASTE DISPOSAL OPTIMIZATION

WMG provides best practices guidance for waste management, ensuring that clients maximize opportunities for waste disposal by effectively classifying, characterizing, and packaging waste for optimized disposal.

### LINER SERVICES

WMG specializes in the production of various metal liners designed to interface with commonly used casks in the industry, ranging from 8-120s to 14-215s. We offer standard designs with 1/4" thick steel shells. Depending on your needs, we can offer liners that can be lifted from the lid or from the body and we are happy to supply liners with secondary lids. With WMG, you're not just getting liners; you're investing in innovation, precision, and a commitment to elevating industry standards.



### RADMAN™ A Platform of Software & Services



At 90 of 93 operating nuclear power plants (NPPs) in the US, all US NPP decommissioning projects  
Working with several US and Canadian nuclear related government installations  
Harmonized with IAEA.



## TRUST

Trust is fragile. It is difficult to earn and easy to lose. As our industry has evolved, companies have come and gone, yet WMG continues to thrive, in large part because of the trust our clients have in our capabilities. Our success is entirely dependent upon your success.

Recent years have put increased pressure on our industry, and we are all asked to do more with less in the name of survival. Experienced professionals are retiring from the industry and in many cases, this process knowledge and expertise isn't being replaced.

As a proud, independent, family-owned small business, specializing in software, engineering, characterization and management of radioactive material, our employees have always been our greatest asset. Our employees are recognized experts in the industry and highly respected by clients, competitors, regulators and industry groups for their capabilities and experience.

Even with all of the new challenges we face, our mission of providing excellence in radioactive waste management through service, innovation, value and integrity remains unchanged, and more important than ever.

Allow us the opportunity to earn your trust and we will show you what it means to have a partner in the industry that is just as committed to your success as you are.

Sincerely,  
Kevin Tuite  
President and CEO  
WMG, Inc.

framatome

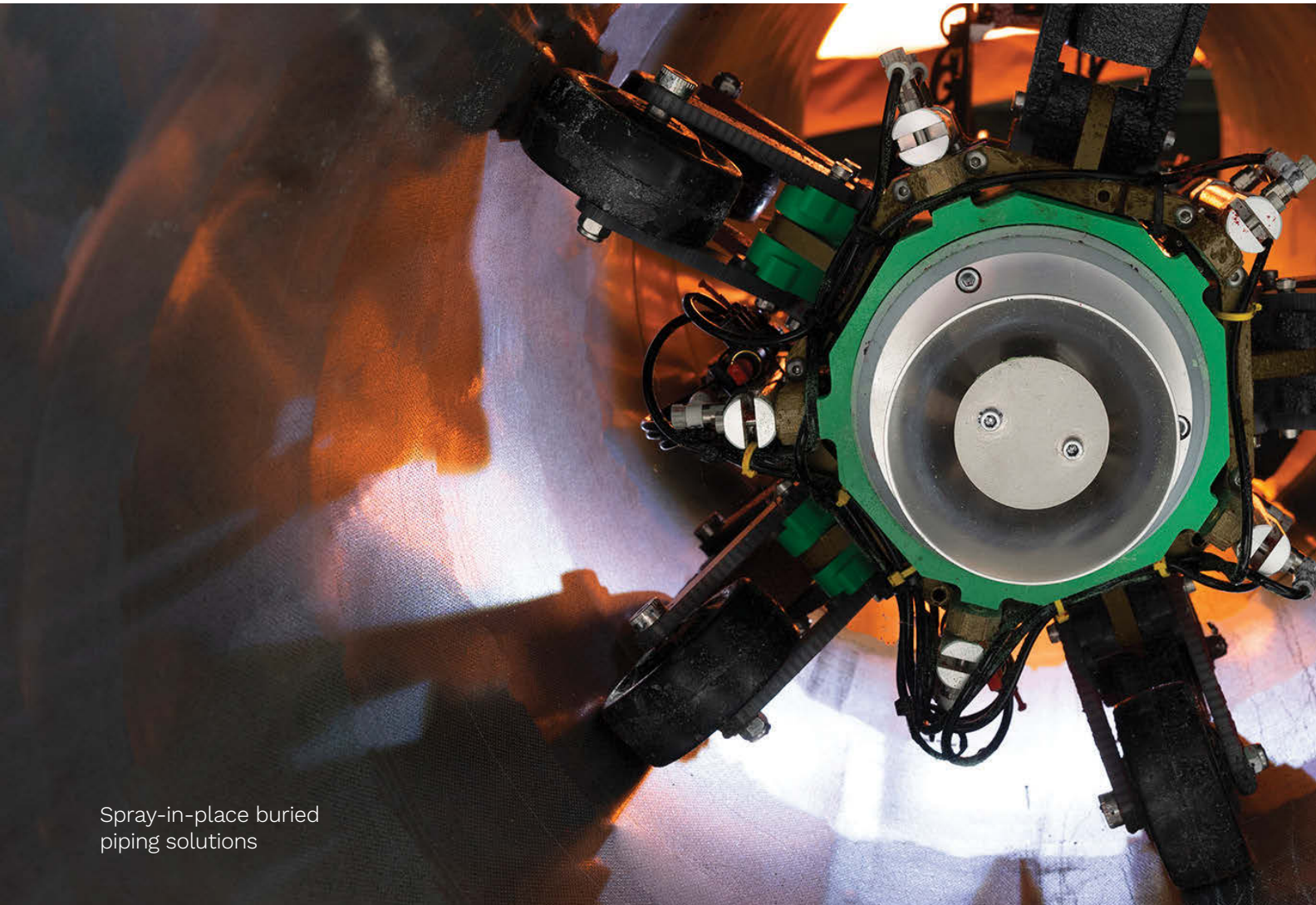

Spray-in-place buried  
piping solutions

Delivering innovations with  
performance you expect





Together, we're securing our clean energy future. How? By improving plant performance, ensuring long-term operations and advancing the next generation of reactors.

Our experts are collaborating with you to develop the innovative

technologies and solutions needed to meet these goals.

We're committed to a clean energy future, and we're going above and beyond to help you achieve it.

**Count on it.**



© 2024 Framatome Inc. All rights reserved.



Learn more about our innovative solutions



# Index to Advertisers

◆ Advertisers are denoted with a diamond next to their company name throughout this directory.

To request information about the products and services advertised in this directory, please see the contact information below or refer to the Directory of Suppliers section on pages 129–160. Company contact information can also be viewed online at [www.ans.org/advertising/nbnbg/da](http://www.ans.org/advertising/nbnbg/da).

## PAGE ADVERTISER

- 
- 32 **Aerofin • [www.aerofin.com](http://www.aerofin.com)**  
Dan Posid • 434/528-6220 • 800/237-6346 • [dposid@aerofin.com](mailto:dposid@aerofin.com)
- 
- 99 **Ahlberg Cameras • [www.ahlbergcameras.com](http://www.ahlbergcameras.com)**  
Drake Courie • 910/ 612-6814 • [drake.courie@ahlbergcameras.com](mailto:drake.courie@ahlbergcameras.com)
- 
- 83 **Allied Power • [alliedpwr.com](http://alliedpwr.com)**  
Dean Sack • 225/412-6455 • [dsack@alliedpwr.com](mailto:dsack@alliedpwr.com)
- 
- 71 **Alphasource, Inc. • [www.alphasourceintl.com](http://www.alphasourceintl.com)**  
Andi Bookbinder/Brian Bookbinder • 215/844-6470 • 800/292-7247 • [sales@alphasourceintl.com](mailto:sales@alphasourceintl.com)
- 
- 9 **American DND Inc. • [www.americandnd.com](http://www.americandnd.com)**  
Bill Schaab • 716/984-7566 • 866/699-5515 • [bschaab@americandnd.com](mailto:bschaab@americandnd.com)
- 
- 124 **Banda Group International, LLC • <https://bandagroupintl.com>**  
Zeferino Banda Jr. • 480/636-8734 • [zef@bandagroupintl.com](mailto:zef@bandagroupintl.com)
- 
- 55 **Barnhart Nuclear Services • [www.barnhartcrane.com](http://www.barnhartcrane.com)**  
Jim Faux • 901/233-3804 • 800/587-3249 • [jfaux@barnhartcrane.com](mailto:jfaux@barnhartcrane.com)
- 
- 64 **G.D. Barri & Associates, Inc. • [www.gdbarri.com](http://www.gdbarri.com)**  
Michelle Manley • 623/773-0410 • [michelle.manley@gdbarri.com](mailto:michelle.manley@gdbarri.com)  
Alice Granado • 623/773-0410 • [alice.granado@gdbarri.com](mailto:alice.granado@gdbarri.com)
- 
- 47 **Bechtel • [www.bechtel.com](http://www.bechtel.com)**  
Todd Powers • 703/429-6704 • 240/344-9615 • [trpowers@bechtel.com](mailto:trpowers@bechtel.com)
- 
- 48 **Boston Government Services, LLC (BGS) • [www.bgs-llc.com](http://www.bgs-llc.com)**  
Paul Adams • 803/257-5226 • 866/730-7353 • [padams@bgs-llc.com](mailto:padams@bgs-llc.com)  
Cecil Parks • 865/272-8400 x1118 • [cparks@bgs-llc.com](mailto:cparks@bgs-llc.com)
- 
- 87 **Bot Engineering Ltd • [www.bot.engineering](http://www.bot.engineering)**  
905/876-4301 (CAN) • 716/304-7041 (US) • [info@botcorp.com](mailto:info@botcorp.com)
- 
- 45 **Brokk Inc. • [www.brokk.com](http://www.brokk.com)**  
Tony Marlow • 505/699-8923 • [tony@brokkinc.com](mailto:tony@brokkinc.com)
- 
- 39 **Constellation PowerLabs • [constellationpowerlabs.com](http://constellationpowerlabs.com)**  
Daniel Doran • 610/380-2475 • [daniel.doran@constellation.com](mailto:daniel.doran@constellation.com)
- 
- 121 **Conval, Inc. • [www.conval.com](http://www.conval.com)**  
Don Bowers • 860/749-0761 • [dbowers@conval.com](mailto:dbowers@conval.com)  
Kristopher Stevens • 860/749-0761 x223 • [kstevens@conval.com](mailto:kstevens@conval.com)
- 
- 94 **Curtiss-Wright EST Group • [www.cw-estgroup.com](http://www.cw-estgroup.com)**  
David Kronen • 267/903-5593 • 800/355-7044 • [est-sales@curtisswright.com](mailto:est-sales@curtisswright.com)
- 

[ans.org/advertise](http://ans.org/advertise) | [advertising@ans.org](mailto:advertising@ans.org)

The publisher does not assume any liability for errors or omissions. The index is provided as an additional reader service.

# Looking for Safe and Compliant Decommissioning Services?

Please, check us out: [www.AmericanDND.com](http://www.AmericanDND.com)



Experience where it matters most:  
PLANNING • DESIGN • EXECUTION

E-mail: [ADND@AmericanDND.com](mailto:ADND@AmericanDND.com)  
Visit: [www.AmericanDND.com](http://www.AmericanDND.com)  
Call: 866-699-5515

American Demolition and Nuclear Decommissioning  
It's no accident your project is performed safely when you hire  
**American DND**





# Index to Advertisers

PAGE ADVERTISER

---

43 **Curtiss-Wright Nuclear Division • [www.cwnuclear.com](http://www.cwnuclear.com)**  
Gary Wolski • 714/337-2512 • [gwolski@curtisswright.com](mailto:gwolski@curtisswright.com)

---

49 **Dominion Engineering, Inc. • [www.domeng.com](http://www.domeng.com)**  
Dale Vines • 703/657-7300 • 225/305-3428 • [dvines@domeng.com](mailto:dvines@domeng.com)

---

93 **DuBose National Energy Services, Inc. • [www.dubosenes.com](http://www.dubosenes.com)**  
Beau Laslo • 910/590-2151 • 800/590-2151 • [beau.laslo@dubosenes.com](mailto:beau.laslo@dubosenes.com)

---

113 **Element Nuclear (NTS Labs) • [www.element.com](http://www.element.com)**  
Greg Mason • 256/603-0903 • [greg.mason@element.com](mailto:greg.mason@element.com)

---

11 **EnergySolutions • [www.energysolutions.com](http://www.energysolutions.com)**  
Mark Walker • 801/649-2000 • [mwalker@energysolutions.com](mailto:mwalker@energysolutions.com)

---

1 **EXCEL Services Corporation • [www.excelservices.com](http://www.excelservices.com)**  
Donald R. Hoffman • 301/984-4400 • [donald.hoffman@excelservices.com](mailto:donald.hoffman@excelservices.com)

---

103 **F&J SPECIALTY PRODUCTS, INC. • [www.fjspecialty.com](http://www.fjspecialty.com)**  
Sales Coordinator • 352/680-1177/1178 • 888/832-5037 • [fandj@fjspecialty.com](mailto:fandj@fjspecialty.com)

---

6-7 **Framatome Inc. • [www.framatome.com](http://www.framatome.com)**  
Donna Gaddy-Bowen • 434/832-3702 • [donna.gaddybowen@framatome.com](mailto:donna.gaddybowen@framatome.com)

---

41 **Frham Safety Products, Inc. • [www.frhamsafety.com](http://www.frhamsafety.com)**  
Trip McGarity • 803/366-5131 • [trip@frhamsafety.com](mailto:trip@frhamsafety.com)

---

102 **HI-Q Environmental Products Co., Inc. • [www.HI-Q.net](http://www.HI-Q.net)**  
Marc A. Held • 858/549-2820 • [info@hi-q.net](mailto:info@hi-q.net)

---

109 **Holtec International • [www.holtecinternational.com](http://www.holtecinternational.com)**  
Joy Russell • 856/797-0900 x3655 • [j.russell@holtec.com](mailto:j.russell@holtec.com)

---

117 **I.C.E. Service Group, Inc. • [www.iceservicegroup.com](http://www.iceservicegroup.com)**  
Dennis Morgan, II • 412/916-5710 • [dmorgan@iceservicegroup.com](mailto:dmorgan@iceservicegroup.com)

---

118 **James C. White Company, Inc. • [www.jcwco.com](http://www.jcwco.com)**  
John A. White • 864/288-4692 • 800/421-9410 • [nuclearsales@jcwco.com](mailto:nuclearsales@jcwco.com)

---

59 **Kiewit Nuclear Solutions Co. • <https://www.kiewit.com/>**  
Josh Patterson • 865/364-8252 • [joshua.patterson@kiewit.com](mailto:joshua.patterson@kiewit.com)

---

66, 89 **LND, Inc. • [www.lndinc.com](http://www.lndinc.com)**  
Bill Lehnert • 516/678-6141 • [info@lndinc.com](mailto:info@lndinc.com)

---

13, 73 **Major Tool & Machine (A Precinmac Company) • [www.majortool.com](http://www.majortool.com)**  
J. David Weyreter • 317/917-4062 • [dweyreter@precinmac.com](mailto:dweyreter@precinmac.com)

---

91 **Mirion Technologies (IST) Corp. • [www.mirion.com](http://www.mirion.com)**  
Tim Pelot • 607/562-4530 • [tpelot@mirion.com](mailto:tpelot@mirion.com)

---



## FOR ALL THINGS NUCLEAR

Serving North American nuclear utilities, medical and research facilities, U.S. and Canadian government agencies, and international companies.

  
**ENERGYSOLUTIONS**

 [energysolutions.com](http://energysolutions.com)



# Index to Advertisers

PAGE ADVERTISER

- 
- 51** **NAC International Inc. • [www.nacintl.com](http://www.nacintl.com)**  
Ellen O'Shea • 678/328-1221 • 770/447-1144 • eoshea@nacintl.com  
George Vaughan • 678/328-1222 • 770/447-1144 • gvaughan@nacintl.com
- 
- 34** **Netzsch Instruments North America LLC • <https://analyzing-testing.netzsch.com/en-US>**  
Melinda Tucker • 303/895-8175 • melinda.tucker@netzsch.com  
Anthony Maletta • 781/825-5853 • anthony.maletta@netzsch.com
- 
- 30** **NUCON International, Inc. • [www.nucon-int.com](http://www.nucon-int.com)**  
Sales • 614/846-5710 • 800/992-5192 • sales@nucon-int.com  
Gabor Muzsi • 614/846-5710 x136 • 800/992-5192 • sales@nucon-int.com
- 
- 3** **Oak Ridge National Laboratory • <https://www.ornl.gov/>**  
Laura Scheele • 219/381-8672 • scheelela@ornl.gov
- 
- 62** **OTEK Corp. • [www.otekcorp.com](http://www.otekcorp.com)**  
Dr. Otto Fest • 520/748-7900 • sales@otekcorp.com
- 
- 58** **PacTec, Inc. • [www.pactecinc.com](http://www.pactecinc.com)**  
Mike Sanchez • 225/683-8602 • 877/554-2541 • mikesanchez@pactecinc.com
- 
- Cover 4** **Paragon Energy Solutions • [www.paragones.com](http://www.paragones.com)**  
John Portillo • 817/239-1693 • 817/284-0077 • jportillo@paragones.com  
Tighe Smith • 865/966-5330 • tsmith@paragones.com
- 
- 63** **The Park Company • [www.theparkcompany.com](http://www.theparkcompany.com)**  
Michael Christianson • 509/547-9929 • mpc@theparkcompany.com
- 
- 13, 73** **Petersen Inc. (A Precinmac Company) • [www.peterseninc.com](http://www.peterseninc.com)**  
Jason Patterson • 801/732-2476 • 801/317-7519 • jason.patterson@peterseninc.com
- 
- 89** **Photonis • [www.exosens.com/nuclear](http://www.exosens.com/nuclear)**  
Ludovic Gonzalez • +33 556 16 72 41 • nuclearsales@exosens.com
- 
- 90** **Precision Custom Components, LLC. • [www.pcc-york.com](http://www.pcc-york.com)**  
Blair Woodring • 717/848-1126 • bwoodring@pcc-york.com
- 
- 127** **Preferred Engineering Corp. • [www.preferredengineering.com](http://www.preferredengineering.com)**  
Steven Mitchell • 203/743-6741 x1402 • smitchell@preferred-mfg.com  
Christopher Bohn • 203/743-6741 x1403 • cbohn@preferred-mfg.com
- 
- 61** **Presray Corp. • [www.presray.com](http://www.presray.com)**  
Jason Smith • 845/373-6620 • jsmith@presray.com  
Kevin Harris • 845/373-6718 • kharris@presray.com
- 
- Cover 3** **Radiation Safety & Control Services, Inc. • [www.radsafety.com](http://www.radsafety.com)**  
Matthew Whetzel • 603/474-6733 • 800/525-8339 • mdwhetzel@radsafety.com
- 
- 105** **RdF Corporation • [www.rdfcorp.com](http://www.rdfcorp.com)**  
DerZen Fan • 603/882-5195 • dfan@rdfcorp.com  
Shyang Puri • 603/882-5195 • spuri@rdfcorp.com
- 
- 95** **Reef Industries, Inc. • [www.reefindustries.com](http://www.reefindustries.com)**  
Mark Mullin • 800/231-6074 • mmullin@reefindustries.com
- 
- 100** **Remote Ocean Systems (ROS) • [www.rosys.com](http://www.rosys.com)**  
James Connell • 858/565-8500 • jamesc@rosys.com
-



# PRECINMAC™



## CONTAIN YOURSELF

Precinmac is proud to be an integral part of the clean-up of waste generator sites around the country helping to make it a cleaner and safer environment for future generations. Our companies fabricate, machine and test dry fuel storage casks, transportation casks and waste containers for the nuclear industry. In fact, Precinmac companies have delivered over 25,000 high quality containers to customers for over 25 years. We also provide custom manufactured equipment in the vitrification process as well as decommissioning projects worldwide. When it matters, and you want high quality products, call a Precinmac company.

Learn More



Find our companies in this buyer's guide:

**MAJOR + PETERSEN**  
TOOL & MACHINE





# Index to Advertisers

PAGE ADVERTISER

- 
- 120 **Schutte and Koerting • [www.s-k.com](http://www.s-k.com)**  
Power Sales • 215/639-0900 • [sales@s-k.com](mailto:sales@s-k.com)
- 
- 57 **SSM Industries, Inc. • [www.ssmi.biz](http://www.ssmi.biz)**  
Matt Gorman • 412/777-5101 • [mgorman@ssmi.biz](mailto:mgorman@ssmi.biz)
- 
- 53 **Strategic Packaging Systems • [www.spsonline.biz](http://www.spsonline.biz)**  
Rebekah Moreland • 423/545-9505 • [r.moreland@spsonline.biz](mailto:r.moreland@spsonline.biz)
- 
- 77 **Super Radiator Coils • [www.superradiatorcoils.com](http://www.superradiatorcoils.com)**  
Dave Bunce • 952/556-3314 • 952/239-8713 • [dave.bunce@superradiatorcoils.com](mailto:dave.bunce@superradiatorcoils.com)
- 
- 65 **System One • [www.systemone.com](http://www.systemone.com)**  
Mark Fenske • 412/995-1912 • 877/505-SYS1(7971) • [marketing@systemoneservices.com](mailto:marketing@systemoneservices.com)
- 
- 69 **T&T Enterprises • [www.ttenterprises.com](http://www.ttenterprises.com)**  
Brent Thalasinis • 951/340-0911 • [brent@ttenterprises.com](mailto:brent@ttenterprises.com)
- 
- 78 **Thermal Engineering International (TEI) • <https://www.babcockpower.com/tei/>**  
Jennifer Pasquariello • 508/439-0146 • [jpasquariello@babcockpower.com](mailto:jpasquariello@babcockpower.com)
- 
- 111 **Thermo Scientific - CIDTEC Cameras & Imagers • [www.thermofisher.com/cidtec](http://www.thermofisher.com/cidtec)**  
Tony Chapman • 315/451-9410 • 800/888-8761 • [sales.cidtec@thermo.com](mailto:sales.cidtec@thermo.com)
- 
- 98 **Ultra Energy • [www.ultra.energy](http://www.ultra.energy)**  
Bruce Weir (US) • 512/434-2800 • [sales@ultra-nspi.com](mailto:sales@ultra-nspi.com)  
Neil Clarke (UK) • +44 0 7703 751850 • +44 1202 850 450 • [sales@ultra-ncs.com](mailto:sales@ultra-ncs.com)
- 
- 15 **Underwater Construction Corp. • [www.uccdive.com](http://www.uccdive.com)**  
Phil McDermott • 800/USA-DIVE • [pmcdermott@uccdive.com](mailto:pmcdermott@uccdive.com)
- 
- 40, 75 **UniTech Services Group, Inc. • [www.unitechus.com](http://www.unitechus.com)**  
Victor Crusselle • 413/543-6911 x118 • [vcruelle@unitechus.com](mailto:vcruelle@unitechus.com)
- 
- 119 **Urenco USA (UUSA) • [www.urencousa.com](http://www.urencousa.com)**  
Lisa Hardison • 575/394-6099 • [lisa.hardison@urenco.com](mailto:lisa.hardison@urenco.com)
- 
- 122 **Valcor Engineering Corp. • [www.valcor.com](http://www.valcor.com)**  
Thien Nguyen • 973/467-8400 • [nuclear@valcor.com](mailto:nuclear@valcor.com)
- 
- 74 **Wagstaff Applied Technologies • [www.wagstaffat.com](http://www.wagstaffat.com)**  
Dan Payne • 509/321-3184 • [dan.payne@wagstaff.com](mailto:dan.payne@wagstaff.com)
- 
- Cover 2 **Westinghouse Electric Company LLC (Parts Business) • [www.westinghousenuclear.com/parts](http://www.westinghousenuclear.com/parts)**  
Ben Solich • 412/735-5796 • [solichbd@westinghouse.com](mailto:solichbd@westinghouse.com)  
Ryan Vanston • 724/766-3874 • [vanstort@westinghouse.com](mailto:vanstort@westinghouse.com)
- 
- 5 **WMG, Inc. • [www.wmginc.com](http://www.wmginc.com)**  
Jeff Nelson • 914/736-7100 • [jnelson@wmginc.com](mailto:jnelson@wmginc.com)
-





**UNDERWATER**  
CONSTRUCTION CORPORATION

UCCDIVE.COM | (800) USA-DIVE

The Worldwide Leader In  
**NUCLEAR DIVING**  
FOR MORE THAN 50 YEARS

**LEVERAGE THE UCC ADVANTAGE**

*Unparalleled Support for*  
**COMMERCIAL & GOVERNMENT FACILITIES**

- > Committed to Nuclear Excellence
- > 24/7 Emergent Support
- > Global Response Capabilities
- > Exceptional Safety Record
- > Nuclear Staff Augmentation
- > Innovative Underwater Solutions
- > Unmatched In-water Experience
- > ASME Section IX & XI Safety Related Welding
- > UCC Advanced Underwater Coatings
- > NACE CIP I, II, and III Inspectors

**GLOBAL CAPABILITIES AND REGIONAL OFFICES**

CONNECTICUT MICHIGAN SOUTH CAROLINA TENNESSEE TEXAS WISCONSIN



# Index to Categories

The following categories are included in Section I of the Buyers Guide, “Nuclear Products, Materials & Services Directory.” Categories are listed there in alphabetical order, and each category is identified with a code number—for example, “Absorbers, Nuclear Radiation,” code number 00400; “X-ray Diffraction Apparatus,” 96700. Section II, the “Directory of Suppliers,” provides the phone numbers, and contacts of the companies listed in Section I. Extensive cross references are included here, but not in Section I.

## A

00300	Abrasives . . . . .	31
00400	Absorbers, Nuclear Radiation . . . . .	31
01300	Accelerators & Accessories . . . . .	31
	Accelerometers—see <i>Indicators; Vibration; Seismic Instrumentation &amp; Testing</i>	
	Access Control Systems, Personnel—see <i>Security Systems &amp; Devices</i>	
	Acoustic Emission—see <i>Nondestructive Testing</i>	
	Acoustic Sensors—see <i>Sensors</i>	
	Activation Analysis—see <i>Neutron Activation Analysis Services</i>	
	Actuators—see <i>Valve Operators (Actuators)</i>	
02870	Adhesives . . . . .	31
	Adsorbers, Gas—see <i>Filters; Carbon; HEPA; Vacuum (HEPA); Gas Handling Equipment</i>	
02910	Aerosol Neutralizers . . . . .	31
	Aggregate, High-Density Concrete—see <i>Shielding Materials, Radiation</i>	
	Air Analyzers—see <i>Analyzers</i>	
	Air Bubble Detectors—see <i>Detectors, Air Bubble (In Liquid)</i>	
03000	Air-Conditioning & Ventilation Equipment . . . . .	31
	Air Filters—see <i>Filters</i>	
	Air-Flow Control Dampers—see <i>Dampers</i>	
	Air Particulate Samplers—see <i>Samplers &amp; Sampling Systems</i>	
	Air Pressure Regulators—see <i>Regulators, Air Pressure</i>	
	Air Purification Systems—see <i>Respiratory Protection Equipment</i>	
	Air Sampling Pumps—see <i>Pumps, Other</i>	
	Airlocks—see <i>Doors</i>	
03180	Alarm Status Reporting & Control Systems . . . . .	32
03200	Alarm Systems . . . . .	32
03300	Alignment Systems, Rotating Machinery . . . . .	33
	Alloys—see <i>Metals, Other; Testing Services</i>	
	Aluminum—see <i>Metals, Other</i>	
03500	Ammeters, RMS, Tong Test Type . . . . .	33
03550	Amplifiers . . . . .	33
03800	Analysis . . . . .	33
04000	Analyzers . . . . .	35
	Anchors—see <i>Construction Materials</i>	
	Anemometers—see <i>Meteorological Equipment</i>	
	Annunciators—see <i>Alarm Systems; Display Systems, Annunciators</i>	
	Anticoincidence Analyzers—see <i>Analyzers</i>	
	Aprons—see <i>Clothing, Protective, Anti-Contamination; Clothing, Protective, Other Than Anti-Contamination</i>	
	Architect-Engineers—see <i>Construction/Engineering Services</i>	
06790	Asbestos Abatement/Removal Products & Services . . . . .	35
	Asbestos-Free Cement—see <i>Construction Materials</i>	
06820	Assay Equipment, Fuel . . . . .	35
06840	Assay Services, Uranium Ore . . . . .	35
06860	Audits . . . . .	35
06870	Autoclaves . . . . .	36
	Auxiliary Generators—see <i>Generators, Stand-by</i>	

## B

	Badge Services—see <i>Health Physics Services</i>	
	Bag Monitors—see <i>Monitors, Radiation, Area &amp; Special-Purpose</i>	
	Bags—see <i>Health Physics Equipment &amp; Supplies</i>	
06950	Bar-Coding Devices & Supplies . . . . .	36
	Barometers—see <i>Meteorological Equipment</i>	
	Barrel Monitors—see <i>Monitors, Radiation, Area &amp; Special-Purpose</i>	
	Barriers—see <i>Security Structures</i>	
07040	Batteries, Standby . . . . .	36
07060	Battery Capacity Test Equipment . . . . .	36
07070	Battery Chargers . . . . .	36
07080	Battery Monitoring Systems . . . . .	36
07100	Bearings . . . . .	36
07120	Bearings, Self-Lubricating . . . . .	36
	Behavioral Observation—see <i>Consultants; Security Services; Testing, Psychological; Training</i>	
07200	Bellows, Metal . . . . .	36
	Beta-Shielding Labwear, Sheetting—see <i>Clothing, Protective, Anti-Contamination; Shielding Materials, Radiation</i>	
	Bibs—see <i>Clothing, Protective, Anti-Contamination; Clothing, Protective, Other Than Anti-Contamination</i>	
	Binoculars—see <i>Remote-Viewing Instruments &amp; Systems</i>	
	Biomedical Radiation-Counting—see <i>Health Physics Equipment &amp; Supplies</i>	
	Bladders, Storage Tank—see <i>Diaphragms, Storage Tank</i>	
	Blankets, Lead Wool—see <i>Metals, Lead; Shielding Materials, Radiation</i>	
	Blowers—see <i>Air-Conditioning &amp; Ventilation Equipment</i>	
07310	Boilers . . . . .	36
	Bolt-Tensioning—see <i>Maintenance &amp; Repair Services</i>	
07330	Bolts, Foundation . . . . .	36
07340	Bolts, Turbine-Coupling . . . . .	36
	Booths, Security—see <i>Security Structures</i>	
07370	Bootings for Tongs . . . . .	36
	Boots—see <i>Clothing, Protective, Anti-Contamination; Clothing, Protective, Other Than Anti-Contamination</i>	
	Borescopes—see <i>Remote-Viewing Instruments &amp; Systems</i>	
	Boron—see <i>Metals, Steel; Neutron Absorbers; Shielding Materials, Radiation</i>	
	Boron Concentration Meters—see <i>Meters; Reactor Instrumentation &amp; Monitoring Systems</i>	
07800	Brackets, Supports . . . . .	36
	Breather Filters, Drum—see <i>Containers</i>	
	Breathing Air Quality Analysis—see <i>Health Physics Services</i>	
	Bricks, Shielding—see <i>Metals, Lead; Shielding Materials, Radiation</i>	
08000	Bubble Chambers . . . . .	37
	Bubble Suits—see <i>Clothing, Protective, Anti-Contamination</i>	
08100	Buildings, Portable or Temporary . . . . .	37
	Bullet-Resistant Doors, Wall Panels, Windows—see <i>Doors; Security Structures</i>	
	Burnable Poisons—see <i>Neutron Absorbers</i>	
	Bus Bar Insulating Service—see <i>Maintenance &amp; Repair Services</i>	

# Index to Categories



## C

08400	Cabinets & Panels, Instrument . . . . .	37
	Cable Coatings— <i>see Coatings; Cable</i>	
08800	Cable, Electrical . . . . .	37
09100	Cable, Fiber Optic . . . . .	37
	Cable Condition Monitor— <i>see Monitors, Other Than Radiation</i>	
	Cable Management— <i>see Computer Software</i>	
09400	Cable Ties . . . . .	37
	Cable Tray Insulation— <i>see Insulation, Thermal</i>	
	Cable Tray Supports— <i>see Brackets, Supports</i>	
	Cable Trays— <i>see Trays</i>	
09550	Cable Wrap, Separation, Fire-Resistant . . . . .	37
	Cadmium— <i>see Neutron Absorbers</i>	
09730	Calciners . . . . .	37
09750	Calibration Equipment & Systems . . . . .	37
	Calibration Gases, Radioactive— <i>see Radioisotopes</i>	
09800	Calibration Services . . . . .	37
	Calibration Standards— <i>see Radioisotopes</i>	
09870	Calorimeters . . . . .	38
09875	Camera Systems, Motion Magnification . . . . .	38
09880	Camera Systems, Radiation-Hardened . . . . .	38
09900	Carbon, Activated . . . . .	38
	Carbon, Total Organic, Analyzers— <i>see Analyzers</i>	
09950	Cars, Railroad . . . . .	38
10010	Casings, Primary Coolant Pump . . . . .	38
	Casks— <i>see Containers</i>	
	Castings— <i>see Metal Components &amp; Structures</i>	
	Catwalks— <i>see Gratings, Catwalks, Stair Treads</i>	
	Cement— <i>see Construction Materials</i>	
10100	Ceramic Products . . . . .	38
	Chambers, Fission— <i>see Fission Chambers</i>	
	Chambers, Ion— <i>see Counters, Detectors, Radiation; Detector Heads, Sold Separately; Monitors, Radiation, Personnel</i>	
	Channels, Fuel— <i>see Fuel Channels</i>	
	Charcoal, Activated— <i>see Carbon, Activated; Filter Services; Filters</i>	
	Chargers, Dosimeter— <i>see Health Physics Equipment &amp; Supplies</i>	
	Changers, Sample— <i>see Sample Changers</i>	
	Chart Recorders, Strip— <i>see Data Readout Devices, Terminals &amp; Accessories</i>	
	Chemical Analysis— <i>see Analysis</i>	
	Chemical Process Design— <i>see Consultants</i>	
	Chemicals, Decontamination— <i>see Decontamination Chemicals, Equipment &amp; Services</i>	
	Chillers— <i>see Air-Conditioning &amp; Ventilation Equipment</i>	
	Chlorine Monitoring Systems— <i>see Monitors, Other Than Radiation</i>	
	Circuit Breakers— <i>see Electrical Distribution &amp; Control Equipment</i>	
	Circulators, Gas— <i>see Gas Handling Equipment</i>	
	Cladding— <i>see Fuel Element Cladding; Metal Cladding Services</i>	
	Clamps— <i>see Tubing Clamps, Supports</i>	
	Cleaning (Clothing)— <i>see Health Physics Equipment &amp; Supplies; Health Physics Services</i>	
10780	Cleaning Equipment . . . . .	38
	Cleaning Services— <i>see Decontamination Chemicals, Equipment &amp; Services; Maintenance &amp; Repair Services</i>	
10850	Clothing, Protective, Anti-Contamination . . . . .	38
10900	Clothing, Protective, Other Than Anti-Contamination . . . . .	40
	Cloths, Wiping— <i>see Wipers, Wiping Cloths</i>	
	Cleaning— <i>see Decontamination Chemicals, Equipment &amp; Services</i>	
11400	Coatings . . . . .	40
	Coatings Testing— <i>see Test Equipment &amp; Supplies</i>	
	Coincidence Analyzers— <i>see Analyzers</i>	
	Collars, Streaming— <i>see Shielding Materials, Radiation</i>	
11600	Columns, Processing . . . . .	41
	Combiners, Hydrogen— <i>see Gas Handling Equipment</i>	
	Commercial Grade Dedication Services— <i>see Consultants</i>	
	Communications— <i>see Consultants; Information Services</i>	
11650	Communication Systems . . . . .	41
11680	Compactor Disks, for Drums . . . . .	41
11700	Compactors . . . . .	41
	Compliance Support, Regulatory— <i>see Consultants; Health Physics Services; Maintenance &amp; Repair Services</i>	
	Components, Metal— <i>see Metal Components &amp; Structures</i>	
	Compressed Air Pressure Vessels— <i>see Respiratory Protection Equipment; Vessels</i>	
12100	Compressors, Refrigerant . . . . .	41
	Computer-Aided Design— <i>see Computer Services</i>	
12720	Computer & Cyber Security . . . . .	41
12750	Computer Services . . . . .	41
12800	Computer Software . . . . .	42
12900	Computers & Accessories . . . . .	44
	Concentrators— <i>see Radioactive Waste Handling &amp; Treatment Equipment</i>	
	Concrete— <i>see Construction Materials; Maintenance &amp; Repair Services; Shielding Materials, Radiation</i>	
	Concrete Anchors— <i>see Construction Materials</i>	
13050	Concrete Breaking, Drilling, Sawing & Scabbling . . . . .	44
	Concrete Leak Repair— <i>see Maintenance &amp; Repair Services</i>	
	Concrete Reinforcement, Bar & Mesh— <i>see Construction Materials</i>	
	Condensate Polishing— <i>see Water Treatment Equipment &amp; Supplies</i>	
13180	Condensers, Air-Cooled . . . . .	44
13200	Condensers, Power Plant . . . . .	46
13220	Condensing Pots, Steam . . . . .	46
	Condensing Units— <i>see Air-Conditioning &amp; Ventilation Equipment</i>	
	Conductivity Meters— <i>see Meters</i>	
	Configuration Management— <i>see Computer Software; Consultants; Records Management Systems</i>	
13400	Connectors . . . . .	46
13600	Consoles, Control . . . . .	46
13700	Construction Materials . . . . .	46
13850	Construction/Engineering Services . . . . .	46
14000	Consultants . . . . .	47
	Contactors— <i>see Electrical Distribution &amp; Control Equipment</i>	
14300	Containers . . . . .	52
	Containment Air/Gas Sampling Pumps— <i>see Pumps, Other</i>	
	Containment Enclosures, Radiological— <i>see Health Physics Equipment &amp; Supplies; Radioactive Waste Handling &amp; Treatment Equipment</i>	
	Containment Gas Analyzers— <i>see Analyzers</i>	
	Containment Penetrations— <i>see Penetrations, Containment</i>	
	Containment Structures, Post-Tensioning— <i>see Post-Tensioning Materials &amp; Systems, Containment Structure</i>	
14810	Containment Structures, Reactor . . . . .	52
	Contamination Control— <i>see Cleaning Equipment; Decontamination Chemicals, Equipment &amp; Services; Health Physics</i>	



# Index to Categories

Contract Administration—*see Computer Software; Consultants*

Contraction Rings—*see Welding Equipment*

Control Consoles—*see Consoles, Control*

14950 Control Devices & Systems. . . . .53

15200 Control Equipment, Power Plant (Non-Reactor) . . . . .53

15300 Control Houses, Enclosed . . . . .53

Control Rod Crushers—*see Solid Waste Reduction Equipment & Tools, Radioactive*

Control Rod Drive Handling Tools—*see Reactor Service Tools & Devices*

15600 Control Rod Drives . . . . .53

Control Rod Examination—*see Inspection Services*

16000 Control Rods, Reactor . . . . .54

Converters, Digital/Analog—*see Computers & Accessories*

16800 Converters, Time-to-Pulse-Height . . . . .54

Coolers, Evaporative—*see Air-Conditioning & Ventilation Equipment*

Coolers, Sample—*see Sample Coolers*

Cooling Towers—*see Towers, Cooling*

Cooling Systems, Body—*see Health Physics Equipment & Supplies*

Core Plug Removal Tool—*see Reactor Service Tools & Devices*

17200 Core Structural, Reactor . . . . .54

Corrosion—*see Coatings; Consultants; Testing Services*

17650 Corrosion Inhibitors . . . . .54

Counter Tubes—*see Detector Heads, Sold Separately*

17950 Counters, Detectors, Radiation. . . . .54

Counting-Rate Meters—*see Ratemeters, Counting; Ratemeters-Scalers*

18400 Couplings (Pipe-Joining) . . . . .54

Cover Plates, Floor Drain—*see Drains & Accessories*

Coveralls—*see Clothing, Protective, Anti-Contamination; Clothing, Protective, Other Than Anti-Contamination*

Coverings, Protective—*see Protective Coverings & Tarpaulins*

Covers, Wheel—*see Health Physics Equipment & Supplies*

Craft Labor Support—*see Employment/Personnel Support Services*

18590 Crane Safety Systems. . . . .55

18600 Cranes & Hoists . . . . .55

Crimpers, Tube—*see Pipe & Tube Machinery & Equipment*

Criticality Alarms—*see Alarm Systems*

Criticality Control Products—*see Neutron Absorbers; Shielding Materials, Radiation*

Criticality Hazard Evaluation—*see Consultants*

Crushers, Control Rod—*see Solid Waste Reduction Equipment & Tools, Radioactive*

Crushers, Vial—*see Radioactive Waste Handling & Treatment Equipment*

19280 Cyber Security . . . . .55

Cylinders, UF6—*see Containers*

## D

Dampeners, Pulsation—*see Pulsation Dampeners, Piping*

19450 Dampers . . . . .56

Dams, Nozzle—*see Nozzles*

19700 Data Acquisition/Handling Systems . . . . .56

20000 Data Readout Devices, Terminals & Accessories . . . . .56

Deaerating Heaters—*see Heaters, Feedwater*

20250 Debris/Foreign Object Control . . . . .56

20300 Decommissioning Services . . . . .56

Decon Mats—*see Health Physics Equipment & Supplies*

20350 Decontamination Chemicals, Equipment & Services . . . . .58

20500 Degasifiers. . . . .59

Dehumidifiers—*see Air-Conditioning & Ventilation Equipment*

20700 Demolition & Dismantlement. . . . .59

Demineralizer Equipment—*see Water Treatment Equipment & Supplies*

Deoxygenation—*see Water Treatment Equipment & Supplies*

Design, Computer-Aided—*see Computer Services*

Design, Nuclear Facilities—*see Consultants*

21200 Desuperheaters . . . . .59

21270 Detector Heads, Sold Separately . . . . .59

21300 Detectors, Accelerator Beam . . . . .60

21310 Detectors, Aerosol/Particulate . . . . .60

21320 Detectors, Air Bubble (In Liquid) . . . . .60

21370 Detectors, Explosives. . . . .60

21400 Detectors, Leak . . . . .60

21500 Detectors, Metal . . . . .60

Detectors, Radiation—*see Counters, Detectors, Radiation; Detector Heads, Sold Separately; Monitors, Radiation, Area & Special-Purpose; Monitors, Radiation, Personnel*

22150 Detectors, Resistance Temperature . . . . .60

22200 Detectors, Valve Position . . . . .60

Detergents—*see Decontamination Chemicals, Equipment & Services*

22410 Dewatering Systems & Supplies . . . . .60

Dew Point—*see Hygrometry Instrumentation*

22430 Diaphragms, Storage Tank. . . . .60

Diesel Generators, Stand-by—*see Generators, Stand-by*

Digital Imaging—*see Imaging, Digital*

Digital Spectroscopy Amplifiers—*see Amplifiers*

Disks, Compactor—*see Compactor Disks, for Drums*

Displacement Transducers—*see Transducers*

22660 Display Systems, Annunciators . . . . .60

Disposal, Radwaste—*see Waste Management Services*

22700 Diving Services . . . . .60

Document Storage & Retrieval—*see Computer Software; Records Management Systems*

Documentation, Photo, Plant—*see Video Services*

22800 Doors . . . . .60

Doorway Monitors—*see Monitors, Radiation, Personnel*

Dose Calibrators, Nuclear Medicine—*see Calibration Equipment & Systems*

Dosimeter Chargers—*see Health Physics Equipment & Supplies*

Dosimeters, High-Range—*see Health Physics Equipment & Supplies*

Dosimeters, Personnel—*see Health Physics Equipment & Supplies; Monitors, Radiation, Personnel*

Dosimetry Phantoms—*see Health Physics Equipment & Supplies*

Dosimetry Services—*see Health Physics Services*

Dosimetry Systems, Computerized—*see Health Physics Equipment & Supplies*

23850 Drafting Services . . . . .61

Drain Socks—*see Health Physics Equipment & Supplies*

23900 Drains & Accessories . . . . .61

Drawing Control—*see Computer Software; Records Management Systems*

Drives, Control Rod—*see Control Rod Drives; Reactor Service Tools & Devices*

24000 Drives, Variable-Speed . . . . .61

Drug Testing—*see Audits; Fitness-for-Duty; Security Services*

Drum Breather Filters—*see Containers*

Drum Capping Machines, Remote—*see Radioactive Waste Handling & Treatment Equipment*

# Index to Categories



	Drum Cutting Machines— <i>see</i> <i>Radioactive Waste Handling &amp; Treatment Equipment</i>
24080	Drum Locking Devices . . . . .61
	Drum Monitors— <i>see</i> <i>Monitors, Radiation, Area &amp; Special-Purpose</i>
	Drum Washing Systems— <i>see</i> <i>Radioactive Waste Handling &amp; Treatment Equipment</i>
	Drums, Drum Inserts— <i>see</i> <i>Containers</i>
	Dry Cleaning— <i>see</i> <i>Health Physics Equipment &amp; Supplies; Health Physics Services</i>
	Dry Ice Blasting— <i>see</i> <i>Decontamination Chemicals, Equipment &amp; Services</i>
	Dryers, Air— <i>see</i> <i>Air-Conditioning &amp; Ventilation Equipment</i>
24170	Dryers, Wet Solids . . . . .61
24180	Duct, Cable Bus . . . . .61
24190	Duct, Wiring, Plastic . . . . .62
	Ductwork— <i>see</i> <i>Air-Conditioning &amp; Ventilation Equipment</i>
	Dye Penetrant Testing— <i>see</i> <i>Nondestructive Testing</i>

## E

	Earth Science Services— <i>see</i> <i>Consultants</i>
	Economic Analysis— <i>see</i> <i>Consultants</i>
	Education— <i>see</i> <i>Training</i>
24250	Eductors, Containment Spray . . . . .62
	Effluent Analyzers— <i>see</i> <i>Analyzers</i>
24270	Ejectors . . . . .62
	Electrical Cable— <i>see</i> <i>Cable, Electrical</i>
24300	Electrical Distribution & Control Equipment . . . . .62
	Electrical Engineering— <i>see</i> <i>Analysis; Computer Software; Consultants</i>
	Electrical Heat Tracing— <i>see</i> <i>Heat Tracing, Electrical</i>
	Electrical Insulation— <i>see</i> <i>Insulation, Electrical, Radiation-Resistant</i>
	Electromagnetic Compatibility Testing— <i>see</i> <i>Testing Services</i>
24400	Electrometers . . . . .62
	Electron Beam Generators— <i>see</i> <i>Generators, Electron Beam; Process Irradiation Facilities</i>
	Electron Tubes— <i>see</i> <i>Tubes, Electron</i>
25000	Electronic Instrumentation & Supplies . . . . .62
	Electronic Signal Isolators— <i>see</i> <i>Isolators, Electronic Signal</i>
	Electropolishing— <i>see</i> <i>Cleaning Equipment; Decontamination Chemicals, Equipment &amp; Services</i>
	Element Analysis— <i>see</i> <i>Analysis</i>
	Emergency Lighting Systems— <i>see</i> <i>Lights, Lighting</i>
	Emergency Medical Equipment Services— <i>see</i> <i>Health Physics Equipment &amp; Supplies; Health Physics Services</i>
	Emergency Planning— <i>see</i> <i>Computer Software; Consultants; Training</i>
25250	Emergency Response Equipment . . . . .64
25300	Emergency Warning Systems (Public) . . . . .64
25350	Emergency Warning Systems (Worker) . . . . .64
25400	Employment/Personnel Support Services . . . . .64
25600	Encapsulation, Radioactive Source . . . . .65
	Enclosures, Radiological Containment— <i>see</i> <i>Health Physics Equipment &amp; Supplies</i>
	Encryption Systems, Alarm— <i>see</i> <i>Alarm Systems</i>
	Energy Flow Meters— <i>see</i> <i>Meters</i>
25700	Energy Storage Systems, Thermal . . . . .65
	Engineering Services— <i>see</i> <i>Construction/Engineering Services; Consultants; Health Physics Services</i>
	Enrichment— <i>see</i> <i>Uranium Enrichment Services</i>
	Environmental Analysis— <i>see</i> <i>Analysis; Consultants; Health Physics Services</i>

	Environmental Laws & Regulation— <i>see</i> <i>Training</i>
26080	Environmental Monitoring Equipment . . . . .65
26100	Environmental Monitoring Services . . . . .66
	Environmental Qualification— <i>see</i> <i>Testing Services</i>
	Environmental Test Equipment— <i>see</i> <i>Test Equipment &amp; Supplies</i>
	Equipment Condition Monitoring— <i>see</i> <i>Consultants; Testing Services</i>
26190	Equipment Exchanges . . . . .66
	Equipment Qualification— <i>see</i> <i>Analysis; Computer Software; Testing Services</i>
26230	Equipment Rental . . . . .66
26240	Equipment Sales, Surplus . . . . .67
	Erection Services— <i>see</i> <i>Construction/Engineering Services</i>
	Evaporative Coolers— <i>see</i> <i>Air-Conditioning &amp; Ventilation Equipment</i>
	Evaporators, Waste— <i>see</i> <i>Dryers, Wet Solids; Radioactive Waste Handling &amp; Treatment Equipment</i>
	Exchanges, Equipment— <i>see</i> <i>Equipment Exchanges</i>
	Expansion Joints— <i>see</i> <i>Joints, Expansion; Maintenance &amp; Repair Services</i>
	Expert Systems— <i>see</i> <i>Computer Software; Remote Control, Handling &amp; Positioning Devices &amp; Sys.</i>
	Explosives Detectors— <i>see</i> <i>Detectors, Explosives</i>
26390	Extensometers, Ultrasonic . . . . .67
26410	Extruded Outlets (Pipe) . . . . .67

## F

	Fabric Structures— <i>see</i> <i>Structures, Fabric Tensioned</i>
	Fabricated Metal Components— <i>see</i> <i>Metal Components &amp; Structures</i>
26500	Fabricating Equipment, Metal & Ceramic . . . . .67
26550	Fabrics, Flame-Retardant . . . . .67
	Face Mask Communications— <i>see</i> <i>Communication Systems</i>
	Failure Analysis— <i>see</i> <i>Analysis; Computer Software; Testing Services</i>
26600	Fall Protection Equipment & Devices, Construction & Maintenance . . . . .67
	Fans & Blowers— <i>see</i> <i>Air-Conditioning &amp; Ventilation Equipment</i>
26900	Fasteners . . . . .67
26910	Feedthroughs, Bulkhead . . . . .68
	Feedwater Heaters— <i>see</i> <i>Heaters, Feedwater</i>
	Feedwater Regulators— <i>see</i> <i>Regulators, Feedwater</i>
	Fiber Optic Cable— <i>see</i> <i>Cable, Fiber Optic</i>
26970	Fiber Optic Components & Systems . . . . .68
	Film Badge Services— <i>see</i> <i>Health Physics Services</i>
	Film Badges— <i>see</i> <i>Monitors, Radiation, Personnel</i>
	Filter Efficiency Monitors— <i>see</i> <i>Monitors, Other Than Radiation</i>
27150	Filter Handling/Transfer Systems . . . . .68
27180	Filter Housings . . . . .68
	Filter Test Equipment— <i>see</i> <i>Health Physics Equipment &amp; Supplies</i>
27250	Filter Services . . . . .68
	Filter Transfer Casks— <i>see</i> <i>Containers</i>
	Filter Valves— <i>see</i> <i>Valves, Other</i>
27450	Filters . . . . .68
27650	Filters, Neutron (CdS) . . . . .68
	Finned Tubes— <i>see</i> <i>Tubes, Finned</i>
	Finite-Element Analysis— <i>see</i> <i>Analysis</i>
	Fire Alarm Systems— <i>see</i> <i>Alarm Systems</i>
	Fire Dampers— <i>see</i> <i>Dampers</i>



# Index to Categories

28000	Fire Protection Services	68
28100	Fire Protection, Extinguishers & Suppression	68
28150	Fire Protection, Passive	70
	Fire-Retardant-Treated Lumber—see <i>Construction Materials</i>	
28250	Fireproofing Materials	70
28270	Firestops	70
28300	Fission Chambers	70
	Fit-Testing, Respirator—see <i>Health Physics Services; Respiratory Protection Equipment</i>	
	Fitness-for-Duty—see <i>Audits; Consultants; Security Services; Testing, Psychological; Training</i>	
28390	Fittings, Hose	70
28400	Fittings, Pipe	70
28410	Fittings, Tube	70
	Flame-Retardant Fabrics—see <i>Fabrics, Flame-Retardant</i>	
28500	Flange Refacing Equipment (On-Site)	70
28530	Flanges, Pipe	70
28550	Flanges, Pressure Vessel	70
	Flasks, Water, Valve-Operating—see <i>Vessels</i>	
	Floodlighting—see <i>Lighting Fixtures</i>	
	Floor Drains & Cover Plates—see <i>Drains &amp; Accessories</i>	
	Floor Toppings—see <i>Coatings</i>	
	Flow Calibration—see <i>Calibration Services</i>	
	Flow Indicators—see <i>Indicators</i>	
	Flow Meters—see <i>Meters</i>	
	Flow Monitoring Valves—see <i>Valves, Flow Monitoring/Alarm System</i>	
	Flow Testing—see <i>Testing Services</i>	
	Flux Leakage—see <i>Nondestructive Testing</i>	
	Flux-Mapping Systems—see <i>Reactor Instrumentation &amp; Monitoring Systems</i>	
	Foam Tape—see <i>Tape</i>	
29200	Foils	70
	Food Contamination Monitors—see <i>Monitors, Radiation, Area &amp; Special-Purpose</i>	
	Force/Torque Sensors—see <i>Robotic Devices, Systems; Sensors</i>	
29360	Foreign Material Exclusion	70
	Forgings—see <i>Metal Components &amp; Structures</i>	
	Fracture Mechanics—see <i>Analysis; Testing Services</i>	
	Freeze Plugging/Sealing—see <i>Maintenance &amp; Repair Services; Plugs</i>	
	Frisker Shields—see <i>Shielding Materials, Radiation</i>	
	Friskers—see <i>Monitors, Radiation, Personnel</i>	
	Fuel Assay Equipment—see <i>Assay Equipment, Fuel</i>	
	Fuel Assembly Repair—see <i>Maintenance &amp; Repair Services</i>	
29900	Fuel Channels	72
30000	Fuel Element Cladding	72
30040	Fuel Element Consolidation (Spent Fuel)	72
	Fuel Element Grids—see <i>Grids, Fuel Element</i>	
	Fuel Element Inspection Services—see <i>Inspection Services</i>	
	Fuel Element Inspection Systems—see <i>Fuel Handling Equipment &amp; Systems</i>	
	Fuel Element Monitoring Systems—see <i>Monitors, Other Than Radiation; Reactor Instrumentation &amp; Monitoring Systems</i>	
	Fuel Element Support Structures—see <i>Grids, Fuel Element</i>	
30450	Fuel Elements, Fabricated	72
30500	Fuel Handling Equipment & Systems	72
30600	Fuel Management Services	72
30700	Fuel Marketing Services	72
	Fuel Performance Analysis—see <i>Analysis</i>	
	Fuel Pool Gates—see <i>Gates, Pool</i>	
	Fuel Pool Liners—see <i>Liners, Pool</i>	

	Fuel Reprocessing—see <i>Reprocessing Equipment, Fuel; Reprocessing, Fuel</i>	
	Fuel Shipping Containers—see <i>Containers</i>	
	Fuel Storage Racks—see <i>Racks, Fuel Storage</i>	
	Fuel Storage Services—see <i>Storage Services</i>	
	Fuel Transfer Equipment—see <i>Fuel Handling Equipment &amp; Systems</i>	
31400	Fume Hoods	72
31600	Furnaces	72
31650	Furniture, Control Room	72
31700	Fusion Reactor Components & Systems	72

## G

	Gadolinium—see <i>Neutron Absorbers</i>	
	Gamma Thermometers—see <i>Reactor Instrumentation &amp; Monitoring Systems</i>	
	Gas Analyzers—see <i>Analyzers</i>	
	Gas Circulators—see <i>Gas Handling Equipment</i>	
	Gas Detectors, Monitors—see <i>Detectors, Leak; Monitors, Other Than Radiation</i>	
	Gas Generators—see <i>Gas Handling Equipment</i>	
32250	Gas Handling Equipment	72
	Gas Sampling Systems—see <i>Pumps, Other; Samplers &amp; Sampling Systems</i>	
33200	Gases	73
	Gases, Calibration, Radioactive—see <i>Radioisotopes</i>	
	Gaskets—see <i>Seals</i>	
	Gate Monitors—see <i>Monitors, Radiation, Area &amp; Special-Purpose</i>	
33360	Gates, Pool	73
	Gates, Security—see <i>Security Structures</i>	
33400	Gauges	73
33500	Gearboxes	73
	Geiger-Mueller Tubes—see <i>Detector Heads, Sold Separately</i>	
34200	Generators & Turbines, Emission Control	73
	Generators, Gas—see <i>Gas Handling Equipment</i>	
	Generators, Microwave—see <i>Fusion Reactor Components &amp; Systems</i>	
34800	Generators, Neutron	73
	Generators, Power—see <i>Thermionic Devices; Thermoelectric Devices; Turbine-Generators (Including Stators &amp; Rotors)</i>	
35650	Generators, Signal	73
	Generators, Sodium Hypochlorite—see <i>Water Treatment Equipment &amp; Supplies</i>	
35800	Generators, Stand-by	73
	Generators, Steam—see <i>Steam Generators, Power Plant; Steam Generators, Stand-by, Auxiliary</i>	
	Geotechnical Analysis—see <i>Analysis</i>	
	Gland Packing Systems—see <i>Valve Stem Gland Packing Systems, Live-Loaded</i>	
	Glass, Radiation-Shielding—see <i>Shielding Materials, Radiation; Windows, Radiation-Shielding</i>	
36000	Gloveboxes & Accessories	73
	Gloves—see <i>Clothing, Protective, Anti-Contamination; Clothing, Protective, Other Than Anti-Contamination; Gloveboxes &amp; Accessories</i>	
	Goggles—see <i>Clothing, Protective, Anti-Contamination; Clothing, Protective, Other Than Anti-Contamination</i>	
36800	Graphite	74
36820	Grapples	74
36850	Gratings, Catwalks, Stair Treads	74
	Grease & Oil Interceptors—see <i>Interceptors, Oil &amp; Grease</i>	
36870	Grids, Fuel Element	74



	Grits, Lapping & Polishing— <i>see Abrasives; Nozzles</i>
36900	Grouts . . . . .74
	Guard Stations— <i>see Security Structures</i>
	Guards— <i>see Security Services</i>

## H

	Hafnium— <i>see Metals, Other</i>
	Hangers, Pipe— <i>see Pipe Hangers &amp; Supports</i>
	Harnesses, Safety— <i>see Fall Protection Equipment &amp; Devices, Construction &amp; Maintenance</i>
	Hats— <i>see Clothing, Protective, Anti-Contamination; Clothing, Protective, Other Than Anti-Contamination</i>
37130	Health Physics Equipment & Supplies . . . . .74
37160	Health Physics Equipment & Supplies, Disposable/Soluble . . . . .76
	Health Physics Recordkeeping Systems— <i>see Computer Software; Records Management Systems</i>
37200	Health Physics Services . . . . .76
	Health Testing, Employee— <i>see Health Physics Services</i>
	Hearing Protection Devices— <i>see Clothing, Protective, Anti-Contamination; Clothing, Protective, Other Than Anti-Contamination; Monitors, Other Than Radiation; Noise; Silencers, Steam Safety Valve</i>
37600	Heat Exchangers & Equipment . . . . .76
37660	Heat Sinks, Ultimate . . . . .79
	Heat Stress Monitors— <i>see Health Physics Equipment &amp; Supplies</i>
37700	Heat Tracing, Electrical . . . . .79
37720	Heat Tracing Monitoring & Control Systems . . . . .79
	Heat Transfer Analysis— <i>see Consultants</i>
37780	Heat Treating Services . . . . .79
37800	Heaters, Electric Resistance . . . . .79
38000	Heaters, Feedwater . . . . .79
38200	Heaters, Induction . . . . .79
	Heaters, Neutral Beam— <i>see Fusion Reactor Components &amp; Systems</i>
	Helmets— <i>see Clothing, Protective, Anti-Contamination; Clothing, Protective, Other Than Anti-Contamination</i>
	Hoists— <i>see Cranes &amp; Hoists</i>
	Homeland Security— <i>see Security Systems &amp; Devices</i>
	Hoods— <i>see Fume Hoods; Respiratory Protection Equipment</i>
38440	Hose . . . . .79
	Homeland Security Products— <i>see Security Services; Security Structures; Security Systems &amp; Devices</i>
38600	Hot-Cell Wall Plugs, Sleeves . . . . .79
39300	Hot Laboratories . . . . .79
39400	Hot Laboratory Services . . . . .79
	Housings, Filter— <i>see Filter Housings</i>
	Howitzers, Neutron— <i>see Neutron Howitzers</i>
	Human Factors Engineering— <i>see Consultants</i>
	Humidity Control, Measurement— <i>see Air-Conditioning &amp; Ventilation Equipment; Dehumidifiers; Hygrometry Instrumentation; Meteorological Equipment; Humidity Sensors; Monitors, Other Than Radiation; Humidity, Integrated Leak Rate Test</i>
39650	Hydraulic Systems & Components . . . . .79
	Hydrodynamics— <i>see Consultants</i>
	Hydrogen Combiners— <i>see Gas Handling Equipment</i>
	Hydrogen Analyzers— <i>see Analyzers</i>
	Hydrological Analysis— <i>see Analysis</i>
	Hygiene Services, Industrial— <i>see Health Physics Services</i>
	Hypochlorite Generators— <i>see Water Treatment Equipment &amp; Supplies</i>

## I

	Ice Blasting— <i>see Decontamination Chemicals, Equipment &amp; Services</i>
39960	Imaging, Digital . . . . .79
	Incineration— <i>see Radioactive Waste Handling &amp; Treatment Equipment; Waste Management Services</i>
40050	Indicators . . . . .79
	Indicators, Radiation— <i>see Counters, Detectors, Radiation; Health Physics Equipment &amp; Supplies; Monitors, Radiation, Area &amp; Special-Purpose; Monitors, Radiation, Personnel; Reactor Instrumentation &amp; Monitoring Systems</i>
	Industrial Safety— <i>see Consultants; Safety, Plant; Inspection Services</i>
40700	Information Services . . . . .80
	Infrared— <i>see Nondestructive Testing; Remote-Viewing Instruments &amp; Systems; Test Equipment &amp; Supplies; Testing Services</i>
	Inhibitors, Corrosion— <i>see Corrosion Inhibitors</i>
40775	Injection Systems, Chemical . . . . .80
	Inserts, Drum— <i>see Containers</i>
40900	Inspection Services . . . . .80
	Inspection Systems, X-ray— <i>see Security Systems &amp; Devices; X-ray Inspection Systems</i>
	Instrument Cabinets— <i>see Cabinets &amp; Panels, Instrument</i>
41000	Instrument Services . . . . .80
	Instrumentation, Electronic— <i>see Electronic Instrumentation &amp; Supplies</i>
41015	Instrumentation, Misc. . . . .80
	Instrumentation, Reactor— <i>see Reactor Instrumentation &amp; Monitoring Systems</i>
	Instrumentation, Seismic— <i>see Seismic Instrumentation &amp; Testing</i>
	Instruments, Particle-Measuring— <i>see Particle-Measuring Instruments</i>
41100	Insulation, Electrical, Radiation-Resistant . . . . .80
41200	Insulation, Thermal . . . . .81
41450	Inverters (DC to AC) . . . . .81
	Iodine Filters, Samplers— <i>see Filters; Carbon; HEPA; Gas Handling Equipment; Samplers &amp; Sampling Systems</i>
41550	Ion Chromatography . . . . .81
41700	Ion-Exchange Systems, Materials & Services . . . . .81
42400	Ion Sources . . . . .81
	Ionization Chambers— <i>see Counters, Detectors, Radiation; Detector Heads, Sold Separately; Monitors, Radiation, Personnel</i>
	Irradiation Sample Transfer Systems— <i>see Transfer Systems for Irradiation Samples</i>
42600	Irradiation Services . . . . .81
42800	Irradiators, Isotopic . . . . .81
	Isolation Plugs— <i>see Maintenance &amp; Repair Services; Plugs</i>
42870	Isolators, Electronic Signal . . . . .81
	Isotope Distribution Scanners— <i>see Health Physics Equipment &amp; Supplies</i>
	Isotope Safes— <i>see Safes</i>
43150	Isotope Separation Plants & Equipment . . . . .81
	Isotopes, Radioactive— <i>see Radioisotopes</i>
43400	Isotopes, Stable (Enriched) . . . . .81
	Isotopic Analysis— <i>see Analysis</i>
	Isotopic Irradiators— <i>see Irradiators, Isotopic; Process Irradiation Facilities</i>



# Index to Categories

## J

43700	Joints, Expansion . . . . .	81
	Joints, Pipe—see <i>Pipe Joints</i>	

## K

	Kicksorters—see <i>Analyzers; Pulse-Height, Multi-Channel; Pulse-Height, Single-Channel</i>
--	---

## L

	Lab Coats—see <i>Clothing, Protective, Anti-Contamination; Clothing, Protective, Other Than Anti-Contamination</i>	
	Labeled Compounds—see <i>Radioisotopes</i>	
	Labels—see <i>Bar-Coding Devices &amp; Supplies; Health Physics Equipment &amp; Supplies; Tags &amp; Labels (Warning, Inventory, etc.)</i>	
	Labor—see <i>Employment/Personnel Support Services</i>	
	Laboratories, Hot—see <i>Hot Laboratories</i>	
44000	Laboratories, Mobile . . . . .	81
	Laminations, Metal—see <i>Metal Components &amp; Structures</i>	
	Laminar Flow—see <i>Calibration Equipment &amp; Systems; Indicators; Testing Services</i>	
44070	Lapping Equipment, Precision . . . . .	81
44080	Laser Equipment & Accessories . . . . .	81
44090	Laser Scanning for Dimensional Measurement . . . . .	81
	Laundry Services, Contaminated Clothing—see <i>Health Physics Services</i>	
	Laundry Systems, Contaminated Clothing—see <i>Health Physics Equipment &amp; Supplies</i>	
	Lead Glass—see <i>Windows, Radiation-Shielding</i>	
	Lead Plastic—see <i>Shielding Materials, Radiation; Windows, Radiation-Shielding</i>	
	Leak Detectors, Monitors—see <i>Detectors, Leak; Monitors, Other Than Radiation</i>	
	Leak Repair, Concrete—see <i>Maintenance &amp; Repair Services</i>	
45250	Leak-Sealing Services, On-Line . . . . .	81
	Leak Testing—see <i>Test Equipment &amp; Supplies; Testing Services</i>	
45280	Legal Services . . . . .	81
	Level Indicators—see <i>Indicators; Transmitters</i>	
	Licensing—see <i>Consultants; Training</i>	
45350	Lifts, Aerial . . . . .	81
45550	Lights, Lighting . . . . .	81
	Liners, Container, Drum—see <i>Containers</i>	
	Liners, Hat—see <i>Clothing, Protective, Other Than Anti-Contamination</i>	
45700	Liners, Pool . . . . .	81
	Lithium—see <i>Metals, Other</i>	
	Load Positioners—see <i>Positioners, Load</i>	
	Locking Devices, Drum—see <i>Drum Locking Devices</i>	
46200	Loops, Test . . . . .	82
	Loose Parts Monitors—see <i>Monitors, Other Than Radiation</i>	
	Loose Parts Retrieval—see <i>Analysis; Maintenance &amp; Repair Services; Reactor Service Tools &amp; Devices</i>	
46810	Lubricants . . . . .	82
	Lubrication Analysis—see <i>Analysis</i>	
	Lumber, Fire-Retardant Treated—see <i>Construction Materials</i>	
	Lumber & Pipe Monitors—see <i>Monitors, Radiation, Area &amp; Special-Purpose</i>	
	Luminescent Tape, Warning—see <i>Tape</i>	

## M

46950	Machining Services . . . . .	82
	Magnesium—see <i>Metals, Other</i>	
	Magnetic Particle Testing—see <i>Nondestructive Testing</i>	

47200	Magnets . . . . .	82
	Maintenance Equipment—see <i>Cleaning Equipment; Decontamination Chemicals, Equipment &amp; Services; Tools; Work Platforms; Workbenches, Maintenance, Portable</i>	
47400	Maintenance & Repair Services . . . . .	82
	Man-Tracking Systems—see <i>Health Physics Equipment &amp; Supplies</i>	
	Management Information Systems—see <i>Computer Software; Consultants; Records Management Systems</i>	
47600	Manipulators, Remote . . . . .	84
47620	Mapping Services . . . . .	84
47630	Markers, Identification . . . . .	84
47650	Markers, Pen, for Fabrication . . . . .	84
47670	Markers, Pipe . . . . .	84
	Marketing Services, Fuel—see <i>Fuel Marketing Services</i>	
	Mask Function Test Equipment—see <i>Test Equipment &amp; Supplies</i>	
	Masks—see <i>Respiratory Protection Equipment</i>	
47900	Mass Spectrometers . . . . .	84
	Master-Slave Manipulators—see <i>Manipulators, Remote</i>	
48050	Materials Handling Equipment . . . . .	85
	Materials, Shielding—see <i>Shielding Materials, Radiation</i>	
	Materials Testing, Analysis—see <i>Analysis; Testing Services</i>	
48300	Mechanical Control Devices . . . . .	85
	Mechanical Couplings—see <i>Couplings (Pipe-Joining)</i>	
	Mechanical Seals—see <i>Maintenance &amp; Repair Services; Seals</i>	
	Medical Equipment, Services, Emergency—see <i>Health Physics Equipment &amp; Supplies; Health Physics Services</i>	
	Medical Instrumentation, Nuclear—see <i>Health Physics Equipment &amp; Supplies</i>	
	Medical Radioisotopes—see <i>Radioisotopes</i>	
	Mesh, Concrete Reinforcement—see <i>Construction Materials</i>	
	Metal Alloys & Compounds—see <i>Metals, Other</i>	
48950	Metal Cladding Services . . . . .	85
49000	Metal Components & Structures . . . . .	85
	Metal Detectors—see <i>Detectors, Metal</i>	
	Metal Laminations—see <i>Metal Components &amp; Structures</i>	
49700	Metalizing . . . . .	85
50000	Metallographic Equipment . . . . .	85
	Metallurgical Failure Analysis—see <i>Analysis; Samplers &amp; Sampling Systems</i>	
	Metals, Clad—see <i>Metals, Other</i>	
50250	Metals, Lead . . . . .	85
50300	Metals, Other . . . . .	85
50350	Metals, Steel . . . . .	85
	Metals, Vacuum-Melted—see <i>Metals, Other</i>	
51730	Meteorological Equipment . . . . .	86
	Meteorology—see <i>Consultants</i>	
51850	Meters . . . . .	86
	Meters, Counting-Rate—see <i>Counters, Detectors, Radiation; Ratemeters, Counting</i>	
53600	Microfilming . . . . .	86
	Microprocessor Circuit Boards—see <i>Computers &amp; Accessories</i>	
	Microscopy, Scanning—see <i>Inspection Services</i>	
	Mining, Uranium—see <i>Uranium Mining</i>	
	Mixers, Gas—see <i>Gas Handling Equipment</i>	
	Mobile Laboratories—see <i>Laboratories, Mobile</i>	
53950	Mockup Design & Fabrication . . . . .	86
54000	Model Making . . . . .	86
	Moisture Meters—see <i>Meters</i>	
	Moisture-Sensitive Tape—see <i>Tape</i>	
54300	Moisture Separators & Reheaters . . . . .	86
	Molybdenum—see <i>Metals, Other</i>	





Monitoring & Control Systems, Reactor—*see Reactor Instrumentation & Monitoring Systems*

Monitoring, Environmental—*see Computer Software; Environmental Monitoring Services*

Monitoring Services, Radiation—*see Health Physics Services; Radiation Monitoring Services*

Monitors, Alarm Status—*see Alarm Status Reporting & Control Systems*

Monitors, Heat Stress—*see Health Physics Equipment & Supplies*

54750 Monitors, Other Than Radiation . . . . .86

55040 Monitors, Radiation, Area & Special-Purpose . . . . .87

55060 Monitors, Radiation, Personnel . . . . .88

Monitors, Waste—*see Monitors, Radiation, Area & Special-Purpose*

Mops, Roll, Tacky—*see Health Physics Equipment & Supplies*

55200 Mossbauer-Effect Equipment, Sources. . . . .88

Motor Control Centers—*see Electrical Distribution & Control Equipment*

55300 Motors . . . . .88

Multichannel Analyzers—*see Analyzers*

Multiparameter Analyzers—*see Analyzers*

55470 Multiplexing Systems . . . . .88

Multi-Tube Cable—*see Cable, Electrical*

## N

55490 Neutron Absorbers . . . . .88

55500 Neutron Activation Analysis Services. . . . .88

55550 Neutron Activation Flux Wires & Foils . . . . .88

56400 Neutron Detectors, Reactor . . . . .88

Neutron Filters—*see Filters, Neutron (CdS); Neutron Absorbers*

Neutron-Flux-Mapping Systems—*see Reactor Instrumentation & Monitoring Systems*

Neutron Generators—*see Generators, Neutron*

56460 Neutron Howitzers . . . . .88

56470 Neutron Spectrometers. . . . .88

Nickel & Nickel Base Alloys—*see Metals, Other*

Niobium—*see Metals, Other*

Noise Monitors—*see Monitors, Other Than Radiation*

56600 Nondestructive Testing. . . . .88

56750 Nozzles. . . . .90

Nuclear Safety Analysis—*see Analysis; Consultants*

56900 Nuclear Steam Supply Systems. . . . .90

NuCon Smears—*see Health Physics Equipment & Supplies*

Nuts—*see Fasteners*

## O

Off-Gas Hydrogen Analyzers—*see Analyzers*

Off-Gas Treatment Systems—*see Analyzers; Gas Handling Equipment; Stacks, Off-Gas*

Oil & Grease Interceptors—*see Interceptors, Oil & Grease*

57000 Operating Experience Information Services . . . . .91

Operators, Valve—*see Valve Operators (Actuators)*

57050 Orifices. . . . .91

OSHA Compliance—*see Training*

Outlets, Extruded (Pipe)—*see Extruded Outlets (Pipe)*

Outage Management—*see Consultants; Maintenance & Repair Services*

Overpacks—*see Containers*

Oxygen Analyzers—*see Analyzers*

## P

Packaging—*see Containers*

57400 Packings. . . . .91

57600 Paints . . . . .91

Panelboards—*see Electrical Distribution & Control Equipment*

Panels, Bullet-Resistant—*see Security Structures*

Panels, Shielding—*see Shielding Materials, Radiation*

Pants—*see Clothing, Protective, Anti-Contamination; Clothing, Protective, Other Than Anti-Contamination*

58000 Particle-Measuring Instruments . . . . .91

Particulate Samplers—*see Samplers & Sampling Systems*

Parts, Spare & Replacement—*see Spare & Replacement Parts (Secondary Sources)*

Parts Washers—*see Cleaning Equipment*

Pellet & Slug Presses—*see Presses, Pellet & Slug Forming, Powder Compacting*

Penetration Ports—*see Ports*

Penetration Seals—*see Seals*

58250 Penetrations, Containment . . . . .91

Pens—*see Data Readout Devices, Terminals & Accessories; Markers, Pen, for Fabrication*

Periscopes—*see Remote-Viewing Instruments & Systems*

Personnel—*see Employment/Personnel Support Services*

Personnel Access Control Systems—*see Security Systems & Devices*

Personnel Screening, Investigation—*see Security Services*

Personnel Screening, Stress/Health—*see Consultants; Health Physics Services*

Phantoms, Radiation-Dosimetry—*see Health Physics Equipment & Supplies*

Photodocumentation, Plant—*see Video Services*

58800 Photogrammetry, Close-Range . . . . .91

Photomultiplier Tubes—*see Detector Heads, Sold Separately*

59800 Pipe . . . . .92

59820 Pipe Bending Services . . . . .92

Pipe Cleaning Services—*see Maintenance & Repair Services*

59850 Pipe & Tube Machinery & Equipment. . . . .92

Pipe Fittings—*see Fittings*

Pipe Flanges—*see Flanges, Pipe*

60100 Pipe Hangers & Supports . . . . .92

60150 Pipe Joints . . . . .92

Pipe Markers—*see Markers, Pipe*

Pipe & Lumber Monitors—*see Monitors, Radiation, Area & Special-Purpose*

Pipe Pressure Tester—*see Testers, Pressure, Pipe*

60450 Pipe Whip Restraints . . . . .92

Pipe Wraps/Sleeves—*see Shielding Materials, Radiation*

Pipeline Inspection—*see Inspection Services*

Piping Pulsation Dampeners—*see Pulsation Dampeners, Piping*

Piping Shock Absorbers—*see Shock Absorbers, Piping (Water Hammer); Snubbers*

60900 Piping Systems. . . . .92

Planchet Changers, Automatic—*see Health Physics Equipment & Supplies*

Planchets, Counting—*see Health Physics Equipment & Supplies*

Plant Life Extension, Management—*see Consultants; Maintenance & Repair Services*

Plant Performance Analysis, Monitoring—*see Analysis; Monitors, Other Than Radiation; Testing Services*

Plant Photodocumentation—*see Video Services*

Plant Safety—*see Analysis; Consultants*



# Index to Categories

Plastic Sheeting, Tubing—see *Health Physics Equipment & Supplies; Protective Coverings & Tarpaulins*

Platform-Mounted Nuclear Power Plants—see *Power Plants, Nuclear, Platform-Mounted*

Platforms, Work—see *Work Platforms*

61530 Plating & Anodizing . . . . .92

Plotters—see *Computers & Accessories; Data Readout Devices, Terminals & Accessories*

Plugging—see *Maintenance & Repair Services; Steam Generator Maintenance & Repair*

61570 Plugs . . . . .94

Plugs, Wall, Hot-Cell—see *Hot-Cell Wall Plugs, Sleeves*

61800 Pneumatic Mechanisms . . . . .94

Pneumatic Transfer Systems—see *Transfer Systems for Irradiation Samples*

Polishing Grits—see *Abrasives*

Pool Inspection—see *Inspection Services*

Pool Liners—see *Liners, Pool*

62100 Ponds, Spray . . . . .94

Portal Monitors—see *Monitors, Radiation, Personnel; Doorway*

62200 Ports, Penetration . . . . .94

Post-Accident Sampling Analyzers—see *Analyzers*

62300 Post-Tensioning Materials & Systems, Containment Structure . . . . .94

Post-Tensioning System Surveillance—see *Maintenance & Repair Services*

Powder Compacting Presses—see *Presses, Pellet & Slug Forming, Powder Compacting*

Power Apparatus Testing—see *Test Equipment & Supplies; Testing Services*

Power Condition Monitoring—see *Testing Services*

Power Plant Control Equipment—see *Control Equipment, Power Plant (Non-Reactor); Reactor Instrumentation & Monitoring Systems*

62900 Power Plants, Nuclear, Gen IV Reactors . . . . .94

62910 Power Plants, Nuclear, Gen IV Reactors/Smart & Resilient94

63000 Power Plants, Nuclear, Platform-Mounted . . . . .94

63400 Power Supplies . . . . .94

63800 Preamplifiers . . . . .95

64000 Presses, Pellet & Slug Forming, Powder Compacting . . . . .95

Pressure Indicators—see *Indicators; Meteorological Equipment*

Pressure Testers, Pipe—see *Testers, Pressure, Pipe*

Pressure Transducers—see *Transducers*

Pressure Vessel Flanges & Nozzles—see *Flanges, Pressure Vessel; Nozzles*

Pressure Vessel Shells—see *Shells, Pressure Vessel*

Pressure Vessels—see *Vessels*

64120 Pressurizers, Reactor . . . . .95

Preventive Maintenance—see *Computer Software; Consultants; Maintenance & Repair Services*

Printers—see *Computers & Accessories; Data Readout Devices, Terminals & Accessories*

Probes, Radiation—see *Counters, Detectors, Radiation; Detector Heads, Sold Separately*

64190 Process Irradiation Facilities . . . . .95

Processing Columns—see *Columns, Processing*

Procurement Support—see *Consultants*

Project Management—see *Computer Services; Computer Software; Consultants; Training*

Proportioners, Gas—see *Gas Handling Equipment*

Protective Clothing—see *Clothing, Protective, Anti-Contamination; Clothing, Protective, Other Than Anti-Contamination*

Protective Coatings—see *Coatings; Maintenance & Repair Services*

64300 Protective Coverings & Tarpaulins . . . . .95

Protective Equipment, Personal—see *Clothing, Protective, Other Than Anti-Contamination; Health Physics Services; Respiratory Protection Equipment*

Psychological Testing—see *Testing, Psychological*

64312 Public & Community Relations . . . . .95

64315 Publications . . . . .95

64320 Pulsation Dampeners, Piping . . . . .95

Pulse Amplifiers—see *Amplifiers*

Pulse Generators, Signal—see *Generators, Signal*

Pump Casings, Primary Coolant—see *Casings, Primary Coolant Pump*

64480 Pump Face Seal Protection . . . . .95

Pump Inspection & Repair—see *Maintenance & Repair Services*

64700 Pumps, Centrifugal . . . . .95

64750 Pumps, Other . . . . .96

Purifiers, Gas—see *Gas Handling Equipment*

## Q

66200 Quality Assurance Services . . . . .96

## R

66280 Racks, Fuel Storage . . . . .96

Radiation Absorbers—see *Absorbers, Nuclear Radiation; Neutron Absorbers; Sorbents*

Radiation Counters—see *Counters, Detectors, Radiation; Detector Heads, Sold Separately; Health Physics Equipment & Supplies; Monitors, Radiation, Area & Special-Purpose; Monitors, Radiation, Personnel; Ratemeters, Counting*

Radiation Detection Films—see *Monitors, Radiation, Personnel*

Radiation Detectors—see *Counters, Detectors, Radiation; Detector Heads, Sold Separately; Health Physics Equipment & Supplies; Monitors, Radiation, Area & Special-Purpose; Monitors, Radiation, Personnel*

Radiation Dosimeters—see *Health Physics Equipment & Supplies; Monitors, Radiation, Personnel*

Radiation-Dosimetry Phantoms—see *Health Physics Equipment & Supplies*

Radiation Indicators—see *Counters, Detectors, Radiation; Detector Heads, Sold Separately; Monitors, Radiation, Area & Special-Purpose; Monitors, Radiation, Personnel; Reactor Instrumentation & Monitoring Systems*

Radiation Management—see *Consultants; Health Physics Services; Records Management Systems; Training*

67380 Radiation Monitoring Services . . . . .96

Radiation Monitors—see *Monitors, Radiation, Area & Special-Purpose; Monitors, Radiation, Personnel*

Radiation Probes—see *Counters, Detectors, Radiation; Detector Heads, Sold Separately*

Radiation Protection Recordkeeping Systems—see *Computer Software; Records Management Systems*

Radiation Protection Training—see *Health Physics Services; Training*

Radiation-Shielded Containers—see *Containers*

Radiation-Shielded Doors—see *Doors*

Radiation Shielding—see *Metals, Lead; Neutron Absorbers; Shielding Design, Radiation; Shielding Materials, Radiation; Windows, Radiation-Shielding*

Radiation Standards—see *Radioisotopes*

# Index to Categories



	Radioactive Source Encapsulation—see <i>Radiation Monitoring Services; Encapsulation</i>
	Radioactive Waste Disposal, Low-Level—see <i>Waste Management Services</i>
	Radioactive Waste Management Services—see <i>Waste Management Services</i>
68000	Radioactive Waste Handling & Treatment Equipment . . . .96
	Radiobiological Equipment—see <i>Health Physics Equipment &amp; Supplies</i>
	Radiochemistry—see <i>Equipment Rental; Health Physics Services; Training</i>
	RF Equipment—see <i>Fusion Reactor Components &amp; Systems</i>
68800	Radiographic Equipment & Accessories . . . . .97
68900	Radiography (Services) . . . . .97
	Radioimmunoassay—see <i>Health Physics Services</i>
68950	Radioisotopes. . . . .97
	Radiological Containment Enclosures—see <i>Health Physics Equipment &amp; Supplies</i>
	Radiological Engineering—see <i>Consultants; Health Physics Services</i>
	Radiopharmaceuticals—see <i>Radioisotopes</i>
	Radios—see <i>Communication Systems; Emergency Warning Systems (Public); Emergency Warning Systems (Worker)</i>
	Radon Detection—see <i>Monitors, Radiation, Area &amp; Special-Purpose</i>
	Railroad Cars—see <i>Cars, Railroad</i>
69130	Ratemeters, Counting . . . . .97
69140	Ratemeters-Scalers. . . . .97
	Reactor Cavity Pool Seals—see <i>Seals</i>
	Reactor Containment Structures—see <i>Containment Structures, Reactor</i>
	Reactor Core Structural—see <i>Core Structural, Reactor</i>
	Reactor Cores—see <i>Core Structural, Reactor</i>
	Reactor Heat Recovery Level Monitors—see <i>Monitors, Other Than Radiation</i>
69600	Reactor Instrumentation & Monitoring Systems. . . . .98
	Reactor Period Meters—see <i>Meters</i>
	Reactor Pressure Vessels—see <i>Vessels</i>
	Reactor Axial Offset Meters—see <i>Meters</i>
	Reactor Safety Analysis—see <i>Analysis; Consultants</i>
70600	Reactor Safety Research . . . . .98
70650	Reactor Service Tools & Devices. . . . .98
70660	Reactors, Gen IV . . . . .99
70665	Reactors, Gen IV/Smart & Resilient. . . . .99
70670	Reactors, Heating . . . . .99
	Reactors, Power—see <i>Nuclear Steam Supply Systems</i>
70900	Reactors, Research & Training . . . . .99
70920	Reactors, Space Propulsion . . . . .99
	Rebar—see <i>Construction Materials</i>
	Recirculation Outlet Nozzle Plugs—see <i>Plugs</i>
71100	Recombiners. . . . .99
	Recorders—see <i>Data Readout Devices, Terminals &amp; Accessories; Monitors, Other Than Radiation; Reactor Instrumentation &amp; Monitoring Systems; Records Management Systems</i>
	Recording Charts, Pens—see <i>Data Readout Devices, Terminals &amp; Accessories</i>
71190	Records Management Systems . . . . .99
	Recruitment—see <i>Employment/Personnel Support Services</i>
	Redundant Signal Selector Systems—see <i>Reactor Instrumentation &amp; Monitoring Systems</i>
	Refacing Equipment—see <i>Flange Refacing Equipment (On-Site); Heat Exchangers</i>
	Reference Standards, Metal—see <i>Corrosion Coupons (Metal Reference Standards)</i>

71500	Refrigeration. . . . .99
	Refueling Equipment—see <i>Fuel Handling Equipment &amp; Systems</i>
71700	Refueling Services . . . . .99
	Regeneration, Resin—see <i>Waste Management Services</i>
71900	Regulators, Air Pressure . . . . .100
72000	Regulators, Feedwater. . . . .100
	Regulatory Compliance—see <i>Consultants; Health Physics Services; Maintenance &amp; Repair Services</i>
	Reheaters—see <i>Moisture Separators &amp; Reheaters</i>
	Reinforcing Bar (Rebar)—see <i>Construction Materials</i>
	Relays—see <i>Electrical Distribution &amp; Control Equipment</i>
	Reliability—see <i>Analysis; Computer Software; Consultants; Training</i>
72300	Remote Control, Handling & Positioning Devices & Sys. 100
	Remote Manipulators—see <i>Manipulators, Remote</i>
73300	Remote-Viewing Instruments & Systems . . . . .101
	Rental, Equipment—see <i>Equipment Rental</i>
	Repair Services—see <i>Health Physics Services; Maintenance &amp; Repair Services; Steam Generator Maintenance &amp; Repair</i>
	Replacement Parts—see <i>Spare &amp; Replacement Parts (Secondary Sources)</i>
73350	Reprocessing Equipment, Fuel . . . . .101
73400	Reprocessing, Fuel . . . . .101
	Research, Reactor Safety—see <i>Reactor Safety Research</i>
	Research Reactors—see <i>Reactors, Research &amp; Training</i>
73450	Research Services, Nuclear . . . . .101
	Resin Regeneration—see <i>Waste Management Services</i>
	Resins, Ion-Exchange—see <i>Ion-Exchange Systems, Materials &amp; Services</i>
	Resistance Temperature Detectors—see <i>Detectors, Resistance Temperature; Test Equipment &amp; Supplies; Testing Services</i>
	Respirator Fit Testing—see <i>Health Physics Services</i>
	Respirator Tracking Systems—see <i>Health Physics Equipment &amp; Supplies</i>
	Respiratory Equipment Cleaning, Repair & Testing—see <i>Health Physics Services</i>
73550	Respiratory Protection Equipment . . . . .101
	Restraints—see <i>Pipe Whip Restraints; Seismic Restraints</i>
73570	Rigging Specialists . . . . .101
	Rings, Contraction—see <i>Welding Equipment</i>
73590	Rings, Retaining . . . . .101
	Risk Analysis—see <i>Analysis</i>
73620	Robotic Devices, Systems . . . . .101
	Roll-Formed Metal Components, Shapes—see <i>Metal Components &amp; Structures</i>
	Roll Mops, Tacky—see <i>Health Physics Equipment &amp; Supplies</i>
	Root Cause Analysis—see <i>Analysis; Training</i>
	Rotating Machinery Maintenance—see <i>Alignment Systems, Rotating Machinery; Maintenance &amp; Repair Services</i>
73720	Rubber Lining Services . . . . .101
73730	Rupture Disks, Safety Heads . . . . .101
73750	Rust Removers . . . . .101

## S

73770	Safeguard Systems . . . . .101
73790	Safes . . . . .102
	Safety Analysis—see <i>Analysis; Consultants; Inspection Services; Training</i>
	Safety Belts—see <i>Fall Protection Equipment &amp; Devices, Construction &amp; Maintenance</i>
	Safety Heads, Rupture Disks—see <i>Rupture Disks, Safety Heads</i>



# Index to Categories

Safety Parameter Display Systems— <i>see</i> <i>Reactor Instrumentation &amp; Monitoring Systems</i>	
Safety Research, Reactor— <i>see</i> <i>Reactor Safety Research</i>	
Sample Casks, Post-Accident— <i>see</i> <i>Containers</i>	
73900 Sample Changers . . . . .	102
73950 Sample Coolers . . . . .	102
Sample Transfer Systems— <i>see</i> <i>Transfer Systems for Irradiation Samples</i>	
74150 Samplers & Sampling Systems . . . . .	102
74320 Sampling Systems Services . . . . .	102
Scabbling, Concrete— <i>see</i> <i>Concrete Breaking, Drilling, Sawing &amp; Scabbling; Decontamination Chemicals, Equipment &amp; Services</i>	
74350 Scaffolding . . . . .	102
74400 Scalars . . . . .	104
74600 Scales, Weighing, Nuclear . . . . .	104
Scanners, Isotope Distribution— <i>see</i> <i>Health Physics Equipment &amp; Supplies</i>	
75000 Scintillation Glasses . . . . .	104
75010 Scintillation Plastics . . . . .	104
Scintillators— <i>see</i> <i>Counters, Detectors, Radiation; Detector Heads, Sold Separately</i>	
Scopes, Viewing— <i>see</i> <i>Remote-Viewing Instruments &amp; Systems</i>	
Scrap Melting— <i>see</i> <i>Waste Management Services</i>	
Screening, Investigation— <i>see</i> <i>Consultants; Security Services</i>	
Screening, Psychological, Security— <i>see</i> <i>Consultants; Security Services; Testing, Psychological</i>	
Screens, Traveling— <i>see</i> <i>Water Intake Facilities</i>	
Seal Reconditioning— <i>see</i> <i>Lapping Equipment, Precision; Polishing Equipment, Precision; Reactor Service Tools &amp; Devices</i>	
Sealed Sources— <i>see</i> <i>Radioisotopes; Testing Services; Waste Management Services</i>	
Sealers, Heat— <i>see</i> <i>Adhesives; Heat-Resistant</i>	
75190 Seals . . . . .	104
Secondary Containment Products— <i>see</i> <i>Radioactive Waste Handling &amp; Treatment Equipment</i>	
Security Doors— <i>see</i> <i>Doors</i>	
75500 Security Enforcement Products . . . . .	104
75550 Security for Emergencies & Evacuation . . . . .	104
75600 Security Services . . . . .	104
75700 Security Structures . . . . .	104
75850 Security Systems & Devices . . . . .	104
Seismic Analysis, Qualification— <i>see</i> <i>Analysis; Consultants; Testing Services; Training</i>	
76400 Seismic Instrumentation & Testing . . . . .	105
76600 Seismic Restraints . . . . .	105
77000 Semiconductor Devices . . . . .	105
77250 Sensors . . . . .	105
Sensors, Neutron— <i>see</i> <i>Neutron Detectors, Reactor</i>	
Separation Plants & Equipment, Isotope— <i>see</i> <i>Isotope Separation Plants &amp; Equipment</i>	
Separators— <i>see</i> <i>Moisture Separators &amp; Reheaters; Steam Separators, Power Plant</i>	
77600 Servomechanisms . . . . .	106
Shears, Velocity Limiter— <i>see</i> <i>Solid Waste Reduction Equipment &amp; Tools, Radioactive</i>	
Sheeting, Plastic— <i>see</i> <i>Health Physics Equipment &amp; Supplies; Protective Coverings &amp; Tarpaulins</i>	
77700 Shells, Pressure Vessel . . . . .	106
77750 Shielding Design, Radiation . . . . .	106
77800 Shielding Materials, Radiation . . . . .	106
77830 Shim Stock . . . . .	106
Shipping Containers— <i>see</i> <i>Containers</i>	
Shirts— <i>see</i> <i>Clothing, Protective, Anti-Contamination; Clothing, Protective, Other Than Anti-Contamination</i>	
77860 Shock Absorbers, Piping (Water Hammer) . . . . .	107
Shoes, Shoe Covers— <i>see</i> <i>Clothing, Protective, Anti-Contamination; Clothing, Protective, Other Than Anti-Contamination</i>	
77900 Shoring . . . . .	107
Signal Generators— <i>see</i> <i>Generators, Signal</i>	
Signals, Warning— <i>see</i> <i>Alarm Systems</i>	
Signs, Warning, Radiation— <i>see</i> <i>Health Physics Equipment &amp; Supplies</i>	
78100 Silencers, Steam Safety Valve . . . . .	107
78200 Silicone . . . . .	107
78400 Simulators, Power Plant & Reactor . . . . .	107
Simulators, Radiation— <i>see</i>	
Single-Channel Analyzers— <i>see</i> <i>Analyzers</i>	
Sirens— <i>see</i> <i>Emergency Warning Systems (Public); Emergency Warning Systems (Worker); Inspection Services; Testing Services</i>	
Siting— <i>see</i> <i>Analysis; Consultants</i>	
78700 Sleeves, Wall (Pipe) . . . . .	107
Sludge Analyzers— <i>see</i> <i>Analyzers</i>	
Slurry Pumps— <i>see</i> <i>Pumps, Other</i>	
Smears, Swipes— <i>see</i> <i>Health Physics Equipment &amp; Supplies</i>	
Snubber Repair— <i>see</i> <i>Maintenance &amp; Repair Services; Testing Services; Training</i>	
79000 Snubbers . . . . .	107
79200 Sodium-Handling Equipment . . . . .	107
Sodium Hypochlorite Generators— <i>see</i> <i>Water Treatment Equipment &amp; Supplies</i>	
Sodium Pumps— <i>see</i> <i>Pumps, Other</i>	
Software, Computer— <i>see</i> <i>Computer Software</i>	
79350 Solenoids . . . . .	107
79360 Solid Waste Reduction Equipment & Tools, Radioactive . . . . .	107
79370 Sorbents . . . . .	107
Source Encapsulation— <i>see</i> <i>Radiation Monitoring Services; Encapsulation</i>	
Sorters, Sorting Tables, Radwaste— <i>see</i> <i>Radioactive Waste Handling &amp; Treatment Equipment</i>	
Sources, Ion— <i>see</i> <i>Ion Sources</i>	
Sources, Radioactive— <i>see</i> <i>Radioisotopes; Testing Services</i>	
79740 Spare & Replacement Parts (Secondary Sources) . . . . .	107
Spare Parts Systems— <i>see</i> <i>Consultants; Records Management Systems</i>	
Spectrometers— <i>see</i> <i>Mass Spectrometers; Neutron Spectrometers</i>	
79850 Spectroscopy Systems . . . . .	107
Spent-Fuel Consolidation— <i>see</i> <i>Fuel Element Consolidation (Spent Fuel)</i>	
Spent-Fuel Reprocessing— <i>see</i> <i>Reprocessing, Fuel</i>	
Spent-Fuel Storage— <i>see</i> <i>Racks, Fuel Storage; Storage Services; Storage Systems, Spent-Fuel</i>	
80200 Splitters, Electronic Signal . . . . .	107
Spray Nozzles— <i>see</i> <i>Nozzles</i>	
Spray Ponds— <i>see</i> <i>Ponds, Spray</i>	
80400 Springs . . . . .	108
Stability Monitoring Systems— <i>see</i> <i>Reactor Instrumentation &amp; Monitoring Systems</i>	
Stack Effluent Monitors— <i>see</i> <i>Monitors, Radiation, Area &amp; Special-Purpose</i>	
80520 Stacks, Off-Gas . . . . .	108
Staffing— <i>see</i> <i>Employment/Personnel Support Services</i>	
Stair Treads— <i>see</i> <i>Gratings, Catwalks, Stair Treads</i>	
80565 Standards . . . . .	108

# Index to Categories



Standards, Radiation—see <i>Radioisotopes</i>
Stand-by Generators—see <i>Generators, Stand-by</i>
Starters—see <i>Electrical Distribution &amp; Control Equipment</i>
80600 Startup Services..... 108
Steam Analyzers—see <i>Analyzers</i>
Steam Condensers—see <i>Condensing Pots, Steam</i>
Steam Generator Leak Rate Monitors—see <i>Monitors, Other Than Radiation</i>
80730 Steam Generator Maintenance & Repair..... 108
Steam Generator Nozzles, Nozzle Dams—see <i>Nozzles</i>
Steam Generator Sleeves—see <i>Tubing</i>
80800 Steam Generators, Power Plant..... 108
80900 Steam Generators, Stand-by, Auxiliary..... 108
81000 Steam Separators, Power Plant..... 108
Stellite Ball Punches—see <i>Solid Waste Reduction Equipment &amp; Tools, Radioactive</i>
Stem Gland Packing Systems—see <i>Valve Stem Gland Packing Systems, Live-Loaded</i>
Storage Facilities, Waste—see <i>Radioactive Waste Handling &amp; Treatment Equipment</i>
Storage Racks, Fuel—see <i>Racks, Fuel Storage</i>
81680 Storage Services..... 108
Storage Systems, Energy—see <i>Energy Storage Systems, Thermal</i>
81710 Storage Systems, Spent-Fuel..... 108
Storage Tank Diaphragms—see <i>Diaphragms, Storage Tank</i>
Storage Tanks—see <i>Tanks, Storage</i>
Strain Gauge Testing—see <i>Testing Services</i>
Strainer/Sump Blockage Analysis—see <i>Analysis</i>
81790 Strainers..... 108
Straining Filters, Cloth—see <i>Filters</i>
Strapping Tape, Reinforced (Nuclear)—see <i>Tape</i>
Streaming Collars—see <i>Shielding Materials, Radiation</i>
Stress Analysis—see <i>Analysis</i>
Stress, Personnel—see <i>Consultants; Health Physics Services; Security Services; Testing, Psychological</i>
82200 Stress-Relieving Equipment..... 109
Strip Chart Recorders—see <i>Data Readout Devices, Terminals &amp; Accessories</i>
Structural Analysis—see <i>Analysis</i>
82250 Structural Supports, Component..... 109
Structurals, Reactor Core—see <i>Core Structurals, Reactor</i>
82310 Structures, Fabric Tensioned..... 109
Stud Drive Tool—see <i>Tools</i>
Stud Hole Plugs—see <i>Plugs</i>
Stud Removal Systems (RPV)—see <i>Reactor Service Tools &amp; Devices</i>
Stud Tensioners—see <i>Tensioners, Stud, Hydraulic</i>
Studs—see <i>Fasteners</i>
Sump/Strainer Blockage Analysis—see <i>Analysis</i>
Superconducting Wire—see <i>Wire</i>
82800 Superheaters, Power Plant..... 109
Support Services, Technical & Professional—see <i>Employment/Personnel Support Services; Health Physics Services</i>
Support Structures, Fuel Element—see <i>Grids, Fuel Element</i>
Supports—see <i>Brackets, Supports; Pipe Hangers &amp; Supports</i>
Surface-Conditioning Products (Cleaning, Touchup, Weld Prep, etc.)—see <i>Abrasives; Non-Woven Fiber</i>
Survey Meters—see <i>Monitors, Radiation, Area &amp; Special-Purpose</i>
Swipes—see <i>Health Physics Equipment &amp; Supplies</i>

Switchboards (Power Distribution)—see <i>Electrical Distribution &amp; Control Equipment</i>
82950 Switches..... 109

## T

Tables, Sorting—see <i>Radioactive Waste Handling &amp; Treatment Equipment</i>
83110 Tags & Labels (Warning, Inventory, etc.)..... 110
83120 Tags, Valve..... 110
Tank Linings—see <i>Liners, Pool</i>
83150 Tanks, Storage..... 110
Tantalum—see <i>Metals, Other</i>
83210 Tape..... 110
Targets, Accelerator—see <i>Accelerators &amp; Accessories</i>
Tarpaulins—see <i>Protective Coverings &amp; Tarpaulins</i>
Team Building—see <i>Training</i>
Technical Support Services—see <i>Employment/Personnel Support Services; Health Physics Services</i>
Telerobotics—see <i>Computer Software; Remote Control; Remote-Viewing Instruments &amp; Systems; Robotic Devices, Systems</i>
Telescopes—see <i>Remote-Viewing Instruments &amp; Systems</i>
83600 Television Systems (CCTV)..... 110
Tellurium—see <i>Metals, Other</i>
Temperature Indicators—see <i>Indicators</i>
Temperature Monitors—see <i>Monitors, Other Than Radiation; Temperature</i>
Temperature Sensors—see <i>Meteorological Equipment; Sensors</i>
Temperature Transducers—see <i>Transducers</i>
Tensioning, Bolt—see <i>Maintenance &amp; Repair Services</i>
84000 Tensioners, Stud, Hydraulic..... 110
Tents—see <i>Structures, Fabric Tensioned</i>
84100 Terminal Blocks..... 110
84150 Test Equipment & Supplies..... 110
Test Loops—see <i>Loops, Test</i>
84430 Testers, Pressure, Pipe..... 112
Testing, Nondestructive—see <i>Nondestructive Testing; Training</i>
84550 Testing, Psychological..... 112
84600 Testing Services..... 112
Thermal Analysis—see <i>Analysis</i>
Thermal Hydraulics—see <i>Consultants; Heat Transfer &amp; Fluid Flow</i>
85000 Thermocouples..... 114
85200 Thermoelectric Devices..... 114
85400 Thermoelectric Materials..... 114
Thermometers—see <i>Indicators; Monitors, Other Than Radiation; Temperature; Sensors; Temperature</i>
Thermometers, Gamma—see <i>Reactor Instrumentation &amp; Monitoring Systems</i>
Thermoluminescent Dosimeter Safes—see <i>Safes</i>
Thermoluminescent Dosimeter (TLD) Services—see <i>Health Physics Services</i>
Thermoluminescent Dosimeters—see <i>Monitors, Radiation, Personnel</i>
Thermonuclear—see <i>Fusion Reactor Components &amp; Systems</i>
85700 Thermowells, Resistance Temperature Detector..... 114
Ties, Cable—see <i>Cable Ties</i>
Time-of-Flight Analyzers—see <i>Analyzers</i>
Time-to-Pulse-Height Converters—see <i>Converters</i>
86000 Tissue-Equivalent Materials..... 114
Titanium—see <i>Metals, Other</i>
Tool Monitors, Radiation—see <i>Monitors, Radiation, Area &amp; Special-Purpose</i>
86130 Tools..... 114



# Index to Categories

86150	Torque Indicators	114
86200	Towers, Cooling	114
	Toxicology, Industrial— <i>see Health Physics Services</i>	
	Trailers, Mobile— <i>see Health Physics Equipment &amp; Supplies; Decon Trailers, Mobile; Laboratories, Mobile</i>	
86250	Trailers, Spent-Fuel Transport	114
86260	Trailers, Transport	114
86300	Training	114
86400	Training Centers, Facilities	115
86500	Training Materials, Courseware	116
	Training Reactors— <i>see Reactors, Research &amp; Training</i>	
86750	Transducers	116
	Transfer Cars— <i>see Cars, Railroad</i>	
86800	Transfer Systems for Irradiation Samples	116
86870	Transformers	116
	Transient Voltage Surge Suppression System— <i>see Electrical Distribution &amp; Control Equipment</i>	
86900	Translation Services	116
86970	Transmitters	116
	Transition Joints, Bimetallic— <i>see Joints, Expansion</i>	
87000	Transport Services	116
	Trash Racks— <i>see Water Intake Facilities</i>	
	Traveling Screens— <i>see Water Intake Facilities</i>	
87140	Trays	116
87380	Tritium Handling Equipment	116
	Tritium Monitors— <i>see Monitors, Radiation, Area &amp; Special-Purpose</i>	
87395	Tritium Recycle & Extraction Equipment	117
87400	Tritium Removal Equipment	117
	Tube Clamps, Supports— <i>see Tubing Clamps, Supports</i>	
	Tube Cleaning Equipment— <i>see Cleaning Equipment</i>	
	Tube Crimpers, Cutters, Expanders— <i>see Pipe &amp; Tube Machinery &amp; Equipment</i>	
87680	Tube Extraction (Removal) Equipment	117
	Tube Plugging, Sleeving— <i>see Steam Generator Maintenance &amp; Repair</i>	
87700	Tube Systems	117
	Tubes, Counter & Detector— <i>see Detector Heads, Sold Separately</i>	
87900	Tubes, Electron	117
87950	Tubes, Finned	117
88000	Tubesheets	117
88100	Tubing	117
88200	Tubing Clamps, Supports	118
	Tubing, Plastic— <i>see Health Physics Equipment &amp; Supplies</i>	
	Turbine-Coupling Bolts— <i>see Bolts</i>	
89400	Turbine Gears	118
89500	Turbine-Generators (Including Stators & Rotors)	118
89510	Turbines, Feedwater Pump	118
	Turnstiles— <i>see Security Structures</i>	

## U

	UF6 Cylinders— <i>see Containers</i>	
	Ultrasonic Testing— <i>see Nondestructive Testing; Test Equipment &amp; Supplies</i>	
	Umbilical Cord (Robotic)— <i>see Cable, Electrical</i>	
	Underwater— <i>see Diving Services; Maintenance &amp; Repair Services; Nondestructive Testing; Solid Waste Reduction Equipment &amp; Tools, Radioactive; Video Services; Welding Services</i>	
	Unions— <i>see Couplings (Pipe-Joining)</i>	
89580	Uranium Blending	118
89590	Uranium, Depleted	118

89600	Uranium Conversion	118
89640	Uranium Enrichment Exchange Services	118
89650	Uranium Enrichment Services	118
	Uranium Metal— <i>see Metals, Other</i>	
89760	Uranium Exploration	118
	Uranium Marketing Services— <i>see Fuel Marketing Services</i>	
	Uranium Mill Tailings Reclamation— <i>see Waste Management Services</i>	
89795	Uranium Mining	118
89800	Uranium Ore Concentrates	118
	Uranium Storage— <i>see Containers; Storage Services</i>	
	Urinalysis— <i>see Health Physics Services</i>	

## V

	Vacuum Blasting— <i>see Cleaning Equipment</i>	
90000	Vacuum Breakers	119
90100	Vacuum Equipment & Accessories	119
	Vacuum-Melted Metals— <i>see Metals, Other</i>	
	Valve & Actuator Repair— <i>see Maintenance &amp; Repair Services</i>	
	Valve Grinders (In-Place)— <i>see Valve-Reseating Equipment, On-line</i>	
90250	Valve Operators (Actuators)	119
90280	Valve Packing Removal Equipment	119
	Valve Position Detectors— <i>see Detectors, Valve Position</i>	
90320	Valve-Reseating Equipment, On-line	119
90330	Valve Stem Gland Packing Systems, Live-Loaded	119
	Valve Tags— <i>see Tags, Valve</i>	
	Valve Testing— <i>see Maintenance &amp; Repair Services; Test Equipment &amp; Supplies</i>	
	Valves, Backwater— <i>see Valves, Other</i>	
	Valves, Ball— <i>see Valves, Other</i>	
	Valves, Butterfly— <i>see Valves, Other</i>	
90600	Valves, Check, Stop Check	120
90800	Valves, Control	120
	Valves, Controlled-Closure— <i>see Valves, Check, Stop Check; Valves, Other; Line-Blind</i>	
	Valves, Diaphragm— <i>see Valves, Other</i>	
	Valves, Drain— <i>see Drains &amp; Accessories</i>	
	Valves, Excess-Flow— <i>see Valves, Other</i>	
	Valves, Fail-Safe— <i>see Valves, Other</i>	
	Valves, Feedwater Isolation— <i>see Valves, Other</i>	
	Valves, Filter, In-Line— <i>see Valves, Other</i>	
	Valves, Fire Deluge— <i>see Valves, Other</i>	
	Valves, Flow Monitoring/Alarm System— <i>see Valves, Other</i>	
	Valves, Flush Bottom Tank— <i>see Valves, Other</i>	
91000	Valves, Gate	121
	Valves, Globe— <i>see Valves, Other</i>	
	Valves, Globe, Bellows— <i>see Valves, Other</i>	
	Valves, Instrumentation Manifold— <i>see Valves, Other</i>	
	Valves, Isolation Shutoff— <i>see Valves, Other</i>	
	Valves, Line-Blind— <i>see Valves, Other</i>	
	Valves, Main Steam Isolation— <i>see Valves, Other</i>	
	Valves, Miniature— <i>see Valves, Other</i>	
91260	Valves, Other	121
	Valves, Needle— <i>see Valves, Other</i>	
	Valves, Packless— <i>see Valves, Other</i>	
	Valves, Plastic-Lined— <i>see Valves, Other</i>	
	Valves, Plug— <i>see Valves, Other</i>	
91380	Valves, Pressure Seal	121
	Valves, Pump Recirculation— <i>see Valves, Other</i>	
	Valves, Quick-Opening & -Closing— <i>see Valves, Other</i>	
	Valves, Ram-Type— <i>see Valves, Other</i>	

# Index to Categories



Valves, Relief, Safety—see *Valves, Other*

Valves, Slurry—see *Valves, Other*

Valves, Solenoid—see *Valves, Other*

Valves, Vacuum—see *Valves, Other*

Variable-Speed Drives—see *Drives, Variable-Speed*

Vehicles, Armored—see *Security Systems & Devices*

Ventilation Equipment—see *Air-Conditioning & Ventilation Equipment*

Ventilation Seals—see *Seals*

92150 Venturis . . . . . 122

92300 Vessels . . . . . 122

Vests, Bullet-Resistant—see *Security Systems & Devices*

Vibration Analysis—see *Analysis; Maintenance & Repair Services; Test Equipment & Supplies; Testing Services*

Vibration Indicators—see *Indicators; Monitors, Other Than Radiation; Vibration*

Video Displays—see *Computers & Accessories; Data Readout Devices, Terminals & Accessories; Security Systems & Devices; Television Systems (CCTV)*

92800 Video Services . . . . . 122

## W

Walk-Off Mats—see *Health Physics Equipment & Supplies*

Wall Panels—see *Security Structures; Shielding Materials, Radiation*

Wall Plugs, Sleeves, Hot-Cell—see *Hot-Cell Wall Plugs, Sleeves; Sleeves, Wall (Pipe)*

Wall Thinning Detection, Tube—see *Testing Services*

Warning Signs, Signals—see *Alarm Systems; Health Physics Equipment & Supplies; Lights, Lighting*

Warning Systems—see *Alarm Systems; Emergency Warning Systems (Public); Emergency Warning Systems (Worker)*

Warning Tape, Luminescent—see *Health Physics Equipment & Supplies; Tape*

Waste Evaporators—see *Radioactive Waste Handling & Treatment Equipment*

Waste-Gas Analyzers—see *Analyzers*

Waste Management Consultants—see *Consultants*

93040 Waste Management Services . . . . . 123

Waste Monitors—see *Monitors, Radiation, Area & Special-Purpose*

Waste Tracking & Accountability System—see *Radioactive Waste Handling & Treatment Equipment*

Waste Treatment Equipment—see *Radioactive Waste Handling & Treatment Equipment*

Waste Storage Facilities, Radioactive, On-Site—see *Radioactive Waste Handling & Treatment Equipment*

Water Analyzers—see *Analyzers*

Water Chemistry, Treatment—see *Consultants; Monitors, Other Than Radiation; Training*

Water Filters—see *Filters*

Water Flasks, Valve-Operating—see *Vessels*

Water Hammer Analysis—see *Analysis*

Water, Heavy—see *Heavy Water*

93220 Water Intake Facilities . . . . . 126

Water-Oil Separators—see *Strainers*

93240 Water Quality Management Services . . . . . 126

Water Stills—see *Stills, Water*

Water Strainers—see *Strainers*

93500 Water Treatment Equipment & Supplies . . . . . 126

Weapons, Weapon Storage—see *Security Enforcement Products; Security Structures*

Wear Detection—see *Computer Software*

Weld End Preparation Equipment, Pipe & Tube—see *Pipe & Tube Machinery & Equipment*

Weld Monitors—see *Monitors, Other Than Radiation*

93750 Weld Surfacing . . . . . 126

93800 Welding Equipment . . . . . 126

93900 Welding Services . . . . . 126

95300 Well-Logging Equipment . . . . . 127

Wet-Blasting—see *Cleaning Equipment; Decontamination Chemicals, Equipment & Services*

Wheel Covers—see *Health Physics Equipment & Supplies*

Whole-Body Counting Services—see *Health Physics Services*

Whole-Body Monitors—see *Equipment Rental; Monitors, Radiation, Personnel*

Wind Monitoring—see *Environmental Monitoring Services; Meteorological Equipment*

Window Reducers—see *Solid Waste Reduction Equipment & Tools, Radioactive*

Windows, Bullet-Resistant—see *Security Structures*

95750 Windows, Radiation-Shielding . . . . . 127

Wipe Test Counters—see *Counters, Detectors, Radiation*

95850 Wipers, Wiping Cloths . . . . . 127

95900 Wire . . . . . 127

Wiring Duct—see *Duct, Wiring, Plastic*

Wood Decontamination—see *Waste Management Services*

96200 Work Platforms . . . . . 127

96300 Workbenches, Maintenance, Portable . . . . . 127

Wraps—see *Health Physics Equipment & Supplies; Shielding Materials, Radiation*

96500 Wrenches, Hydraulic Ratchet . . . . . 127

## X

96700 X-ray Diffraction Apparatus . . . . . 127

X-ray Glass—see *Shielding Materials, Radiation; Windows, Radiation-Shielding*

X-ray Inspection Systems—see *Security Systems & Devices*

## Z

Zirconium—see *Metals, Other; Tubing*

# NUCON<sup>®</sup> Products and Services

10CFR50 Appendix B and NQA-1 QA Program  
Licensed Radioisotope Laboratory - ASME Section VIII

## AIR & GAS TREATMENT SYSTEMS AND COMPONENTS

- Complete ESF and non-ESF Air Treatment Systems
- Portable Air Cleaning Units (P-NATS)
- Type II, III and IV Adsorber Cells
- Adsorber Refilling Services
- Gaseous Radwaste and Off-Gas Systems
- Target Dissolver Off-Gas Systems
- Mercury Control Equipment and Systems for Mixed Waste Disposal Operations
- Acid Gas Removal Equipment and Systems
- Gas & Liquid Phase Treatment Systems

## TESTING INSTRUMENTS

- Tracer Gas Detectors and Generators (R-11, R-12, R-112 & R-112A, HCFC-123, R-134a, 1-bromobutane)
- Aerosol Detectors and Generators (DOP, PAO, DOS, etc.)
- Pressure Detectors (Portable)
- Calibration Services; (Halide & Aerosol Instruments, Airflow, Pressure and Temperature Measurement Instruments)

## ADSORBENTS

- Radioiodine Removal Carbons (NUSORB<sup>®</sup> KITEG II<sup>™</sup>, TEG<sup>™</sup> & KIG<sup>™</sup>)
- Noble Gas Delay Bed Carbons
- Mercury Removal Adsorbents (MERSORB<sup>®</sup> series)
- Acid Gas Removal (NUSORB<sup>®</sup> KINA<sup>™</sup> series) and Systems
- VOC Removal (NUSORB<sup>®</sup> GC<sup>™</sup> series)

## RADIOISOTOPE LABORATORY SERVICES

- Radioiodine Removal Performance Testing of New and Used Carbons per USNRC Regulatory Guides, 1.52 (all revisions) & 1.140 (all revisions) and ASTM D3803, RDT-M16-1T, and DIN & DNR
- <sup>133</sup>Xe / <sup>85</sup>Kr Dynamic "K" Testing
- Various Testing Using Radioisotope Tracers

## ON-SITE TESTING AND CONSULTING

- In-place Leak Testing (ASME: N510 & N511 and AG-1)
- Control Room Envelope In Leakage Testing (ASTM E741-2000)
- Acceptance Testing (ASME N510 and AG-1)
- Air Balancing
- Duct and Housing Leakage Testing
- Compliance Review of ESF Air Cleaning Systems
- Personnel Training (ANSI/ASME and ASME AG-1)

## LABORATORY AND ENGINEERING SERVICES

- Control Room Habitability Improvements and Upgrades
- Radioisotope "Heat Decay" Studies
- Chemical Effects Studies (on adsorbants)
- Treatment Technology Development and Design



# NUCON<sup>®</sup> International, Inc

7000 Huntley Road  
Columbus, OH 43229

Phone: 614-846-5710 - Fax: 614-431-0858

Web Site: [www.nucon-int.com](http://www.nucon-int.com)





# 55th Annual Buyers Guide

Nearly 600 companies listed throughout 476 categories of products and services utilized by the nuclear industry

## 00300 Abrasives

- B Bonded
- C Coated
- LP Lapping & Polishing Grits
- NW Non-Woven Fiber

- ◆ Alphasource, Inc., Philadelphia, PA (B, C)
- Bakelite Synthetics, Atlanta, GA (C)
- Desco Mfg. Co., Inc., Rancho Santa Margarita, CA (B, C, LP, NW)
- EFCO USA, Inc., Charlotte, NC (B, C, LP, NW)
- Free Form Fibers, Saratoga Springs, NY (LP, NW)

## 00400 Absorbers, Nuclear Radiation

- 3M Technical Ceramics, Inc., Quapaw, OK
- Camfil USA, Inc., Washington, NC
- Ellis & Watts Global Industries, Inc., (a sub. of Marmon\*, a Berkshire Hathaway company), Batavia, OH
- ◆ Framatome Inc., (North American Headquarters), Lynchburg, VA
- Hopewell Designs, Inc., Alpharetta, GA
- Joseph Oat Corp., Camden, NJ
- METOIL, Praha, Czech Republic (The)
- ◆ NAC International Inc., Peachtree Corners, GA
- Pajarito Scientific Corp., Santa Fe, NM
- Radiation Protection Systems, (by Alpha Safety), Groton, CT

- River Technologies, LLC, Forest, VA
- Roberts Engineering Services, Inc., Stuart, FL
- THERMOCOAX Inc., Alpharetta, GA
- THERMOCOAX SAS, Caligny, France
- Tyne USA Inc., Jacksonville, FL
- Westinghouse Electric Co. LLC, Cranberry Township, PA

## 01300 Accelerators & Accessories

- A Accessories
  - EM Electromagnetic
  - ES Electrostatic
  - O Other
  - T Targets
- Centronic Ltd., Surrey, United Kingdom (EM)
  - Hoskin Scientific, Oakville, Ontario, Canada (T)
  - ◆ LND, Inc., Oceanside, NY (A)
  - MillenniTEK, LLC, Knoxville, TN (T)
  - Superconductivity Innovations, New Windsor, NY (EM)
  - Toshiba America Energy Systems Corp., West Allis, WI (EM, T)

## 02870 Adhesives

- HR Heat-Resistant
- IR Insulation-Related
- RR Radiation-Resistant
- S Structural

- Bakelite Synthetics, Atlanta, GA (HR, IR)
- E.S. Fox Limited, Niagara Falls, Ontario, Canada (S)
- ◆ Element Nuclear (NTS Labs), (Nuclear Engineering & Test Services), Huntsville, AL (RR)
- General Plastics Mfg. Co., Tacoma, WA (HR)
- Hexion Inc., Columbus, OH (HR, IR, S)
- Scientific Sales, Inc., Oak Ridge, TN (HR, IR, RR, S)
- ◆ Westinghouse Electric Company LLC, (Westinghouse Parts Business), New Stanton, PA (HR, IR, RR, S)
- Westlake Epoxy Inc., a Westlake Company, Stafford, TX (HR)

## 02910 Aerosol Neutralizers

- Aegis, LLC, Ooltewah, TN
- Pajarito Scientific Corp., Santa Fe, NM

## 03000 Air-Conditioning & Ventilation Equipment

- AC Air-Conditioning
- AN Air Distribution Nozzles
- AD Air Dryers
- AF Air Filtration Units
- AH Air Handling
- C Chillers
- CO Condensing Units

## Anatomy of a Nuclear News Buyers Guide listing

This section contains an alphabetical listing of nuclear products, materials, and services, with the companies that supply these items. Exactly 476 categories are included (see "Index to Categories," pp. 16–29). Extensive cross references are not included in this section, but can be found in the Index to Categories.

The supplier listings in each category are based on annual updates made by the individual companies to their online verification forms. Nearly 600 companies are represented throughout these pages. Those companies whose names are preceded by a diamond (◆) have an advertisement in the 2024 *Nuclear News Buyers Guide*. Companies highlighted in blue have an advertisement within or near that category.

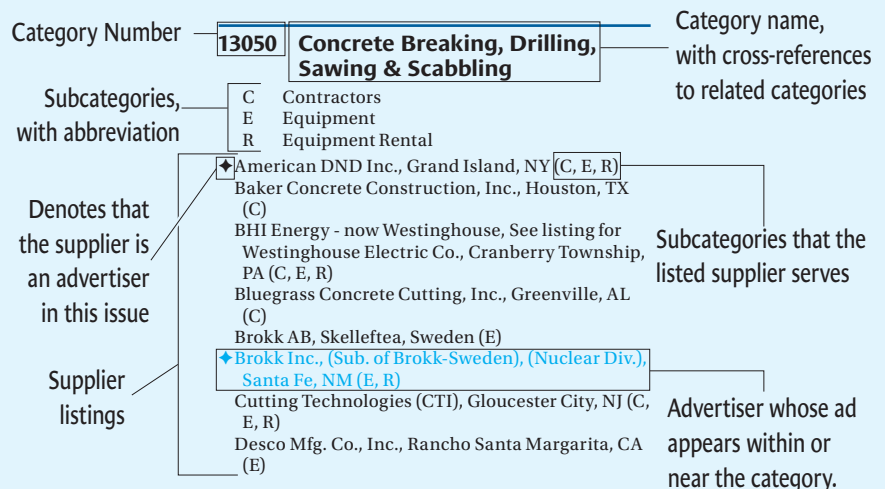

- DH Dehumidifiers
- D Ductwork
- EC Evaporative Coolers
- F Fans & Blowers
- L Louvers
- V Ventilation
- VP Ventilation, Portable
- VT Ventilation, Test Equipment
- AECON-WACHS, (U.S. Div. of Aecon Nuclear), Jackson, SC (D)
- Aegis, LLC, Ooltewah, TN (AF)
- ◆Aerofin, Lynchburg, VA (AC, V)
- BHI Energy - now Westinghouse, See listing for Westinghouse Electric Co., Cranberry Township, PA (AF, F, V, VP)
- Camfil USA, Inc., Washington, NC (AF, V, VP, VT)
- Carolina Fabricators, West Columbia, SC (D)
- ◆Curtiss-Wright Nuclear Division, Brea, CA (AC, AN, AD, AF, AH, C, CO, DH, D, EC, F, L, V)

- Curtiss-Wright Nuclear Division, QualTech NP, Cincinnati, OH (AC, AN, AD, AF, AH, C, CO, DH, D, EC, F, L, V)
- DC Fabricators Inc., Florence, NJ (CO)
- E.S. Fox Limited, Niagara Falls, Ontario, Canada (AC)
- Ellis & Watts Global Industries, Inc., (a sub. of Marmon®, a Berkshire Hathaway company), Batavia, OH (AC, AD, AF, AH, C, CO, DH, D, EC, F, L, V, VP)
- Energy Steel, Rochester Hills, MI (D)
- ◆F&J SPECIALTY PRODUCTS, INC., Ocala, FL (VT)
- ◆Framatome Inc., (North American Headquarters), Lynchburg, VA (C, V)
- ◆Frham Safety Products, Inc., Rock Hill, SC (AD, AF, AH, CO)
- IONEX Research Corp., Lafayette, CO (AF)
- ◆James C. White Company, Inc., Greenville, SC (AC, CO)

- James Fisher Technologies, Loveland, CO (AF, V, VP)
- Lancs Industries, Albuquerque, NM (AF, F, V, VP)
- Mechanical Solutions, Inc., Whippany, NJ (F)
- Mitsubishi Nuclear Energy Systems, Inc., (A Sub. of Mitsubishi Heavy Industries, Ltd.), Charlotte, NC (AC, AN, AD, AF, AH, C, CO, DH, D, EC, F, L, V, VP, VT)
- Nextteq International LLC, Tampa, FL (VT)
- ◆NUCON International, Inc., Columbus, OH (AF, AH, V, VP, VT)

- See advertisement on page 30**
- NuSource LLC, Alexandria, VA (AD, AF, AH, C, CO, F)
  - Pajarito Scientific Corp., Santa Fe, NM (AD, AF, AH, C, CO, DH, D, F, V, VP)
  - ◆Paragon Energy Solutions, (Paragon), Fort Worth, TX (AC, AD, AF, AH, C, CO, EC, F, V)
  - PMT Nuclear, Woodridge, IL (AC, AN, AD, AF, AH, C, CO, DH, D, EC, F, L, V, VP)
  - Radiation Protection Systems, (by Alpha Safety), Groton, CT (AF, F, V, VP, VT)
  - River Technologies, LLC, Forest, VA (AF, AH, D, F, V, VP)
  - Special Electronics & Designs Inc., (SED Inc.), Kincardine, Ontario, Canada (AC, AN, C)
  - ◆SSM Industries, Inc., (Nuclear Div.), Pittsburgh, PA (AC, AD, AF, AH, C, CO, DH, D, EC, F, L, V, VP)
  - ◆Super Radiator Coils, Chaska, MN (AC)
  - Toshiba America Energy Systems Corp., West Allis, WI (AC, AN, AD, AF, AH, C, CO, DH, D, EC, F, L, V, VP, VT)
  - Veolia Nuclear Solutions - Federal Services, Piketon, OH (V, VT)
  - Westinghouse Electric Co. LLC, Cranberry Township, PA (AF, F, V, VP)
  - ◆Westinghouse Electric Company LLC, (Westinghouse Parts Business), New Stanton, PA (AC, AN, AD, AF, AH, C, CO, DH, D, EC, F, L, V, VP, VT)



**EXPERTS IN HEAT TRANSFER  
SINCE 1923—SERVICING THE  
NUCLEAR INDUSTRY FOR  
50+ YEARS**

Aerofin has been manufacturing products for the worldwide nuclear utility industry since 1966. For Fin-Tube Coils (plate or spiral fin options available), Shell & Tube Heat Exchangers, or Automatic Backwash Strainers, Aerofin is the most experienced and uniquely qualified source for safety related and non-safety related nuclear components.

**QUALIFICATIONS**

- NUPIC Audited
- ASME AG-1 CONAGT
- ASME Section III (Class 2 & 3)
- ASME Section VIII
- 10 CFR 50 Appendix B
- 10 CFR 21 Reportability
- ASME NQA-1 / NCA-4000
- LOCA Performance Tested





**4621 Murray Place · P.O. Box 10819 · Lynchburg, VA 24506**  
**(434) 528-6218 · [www.aerofin.com](http://www.aerofin.com)**  
**nuclear@erofin.com**

- 03180 Alarm Status Reporting & Control Systems**
- ARES Security Corp., Vienna, VA
  - Aurum Technologies, Blackfoot, ID
  - ◆Curtiss-Wright Nuclear Division, Brea, CA
  - Curtiss-Wright Nuclear Division, Scientech, Idaho Falls, ID
  - F.E. Moran Special Hazard Systems, Northbrook, IL
  - Mirion Technologies, Inc., (Sensing Systems Div.), Atlanta, GA
  - ◆Paragon Energy Solutions, (Paragon), Fort Worth, TX
  - ◆Radiation Safety & Control Services, Inc., Seabrook, NH
  - Toshiba America Energy Systems Corp., West Allis, WI
  - Westinghouse Electric Co. LLC, Cranberry Township, PA
- 03200 Alarm Systems**
- AI Anti-Intrusion
  - AS Audible Signal
  - C Criticality
  - F Fire
  - FR Flow Rate
  - LE Level
  - LI Limit
  - P Pressure
  - R Radiation
  - RT Reactivity Transient
  - RV Recorded Voice, Digital (Multiple Messages)
  - V Visual Signal
  - ANKUG Engineering Co., Ltd., Seoul, Korea (The Republic of) (F)
  - Aurum Technologies, Blackfoot, ID (C, FR, LE, LI, P, R, V)
  - Bertin Technologies, France (R)
  - BHI Energy - now Westinghouse, See listing for Westinghouse Electric Co., Cranberry Township, PA (AS, R, RV, V)
  - CAEN SyS, (CAEN SpA), Viareggio, LU, Italy (R)
  - DETEK, Temple Hills, MD (R)

◆ Denotes advertiser—see Index to Advertisers on pages 8–14

- ◆ Element Nuclear (NTS Labs), (Nuclear Engineering & Test Services), Huntsville, AL (FR, LE, LI, P)
- F.E. Moran Special Hazard Systems, Northbrook, IL (AS, F, P, RV, V)
- FCI-Fluid Components International, San Marcos, CA (FR, LE)
- ◆ Framatome Inc., (North American Headquarters), Lynchburg, VA (F, LE, R, RT)
- GE Hitachi Nuclear Energy, Wilmington, NC (FR, LE, LI, R)
- General Atomics Electromagnetic Systems, San Diego, CA (R)
- Health Physics Instruments, (Div. of Far West Technology), Goleta, CA (R)
- ◆ HI-Q Environmental Products Co., Inc., San Diego, CA (R)
- Hoskin Scientific, Oakville, Ontario, Canada (FR, LE, LI, P)
- ISO-PACIFIC Remediation Technologies, Inc., Richland, WA (C)
- James Fisher Technologies, Loveland, CO (AS, C, R)
- KROHNE, (KROHNE Nuclear), Romans-sur-Isère, France (FR, LE, P)
- LabLogic Systems, Inc., Chantilly, VA (R)
- MarShield Radiation Shielding, (Div. of Marswell Metal Industries Ltd.), Burlington, Ontario, Canada (R)
- Mirion Technologies (MGPI H&B) GmbH, (Mirion Technologies), Munich, Germany (AS, C, R, RT, V)
- Mirion Technologies, Inc., (Sensing Systems Div.), Atlanta, GA (R)
- NuclearConsultants.com, Ann Arbor, MI (C)
- ORTEC, Oak Ridge, TN (R)
- Overhoff Technology Corp., (A Div. of US Nuclear Corp.), Milford, OH (R)
- Pajarito Scientific Corp., Santa Fe, NM (C, R, RV)
- ◆ Paragon Energy Solutions, (Paragon), Fort Worth, TX (AS, C, F, FR, LE, LI)
- Paschal Solutions, Inc., Knoxville, TN (C)
- Pylon Electronics Inc., (Instrument Manufacturing Div.), Ottawa, Ontario, Canada (R)
- ◆ Radiation Safety & Control Services, Inc., Seabrook, NH (R)
- SOR Inc., Lenexa, KS (LE)
- Special Electronics & Designs Inc., (SED Inc.), Kincardine, Ontario, Canada (AI, AS, C, F, FR, LE, LI, P, R, RT, RV, V)
- Syscom Instruments S.A., Sainte-Croix, Switzerland (R)
- Technology for Energy Corp., Knoxville, TN (AS, FR, V)
- THERMOCOAX SAS, Caligny, France (LE)
- Toshiba America Energy Systems Corp., West Allis, WI (AI, AS, C, F, FR, LE, LI, P, R, RT, RV, V)
- Tyne USA Inc., Jacksonville, FL (R)
- US Nuclear Corp., (Technical Associates Sub.), (Overhoff Technology Corp. Sub.), Canoga Park, CA (R)
- Westinghouse Electric Co. LLC, Cranberry Township, PA (AS, C, FR, LE, LI, P, R, RT, RV, V)
- ◆ Westinghouse Electric Company LLC, (Westinghouse Parts Business), New Stanton, PA (FR, LE, LI, P)

### 03300 Alignment Systems, Rotating Machinery

Toshiba America Energy Systems Corp., West Allis, WI

### 03500 Ammeters, RMS, Tong Test Type

- ◆ Curtiss-Wright Nuclear Division, Brea, CA
- Curtiss-Wright Nuclear Division, QualTech NP, Cincinnati, OH
- Toshiba America Energy Systems Corp., West Allis, WI
- ◆ Westinghouse Electric Company LLC, (Westinghouse Parts Business), New Stanton, PA

### 03550 Amplifiers

- CA CAMAC
- DS Digital Spectroscopy
- DC Direct Current
- PO Power
- PR Pressure
- PU Pulse
- V Video
- WB Wide-Band
- ◆ Bot Engineering Ltd, Campbellville, Ontario, Canada (DS, DC, PR, PU)
- CAEN SyS, (CAEN SpA), Viareggio, LU, Italy (DS)
- Hoskin Scientific, Oakville, Ontario, Canada (DC, PO, PR)
- Mirion Technologies (MGPI H&B) GmbH, (Mirion Technologies), Munich, Germany (DC, PU, WB)
- ORTEC, Oak Ridge, TN (PO, PU)
- Pajarito Scientific Corp., Santa Fe, NM (CA)
- ◆ Paragon Energy Solutions, (Paragon), Fort Worth, TX (PO, PU, WB)
- Tyne USA Inc., Jacksonville, FL (PO, PR)
- ◆ Westinghouse Electric Company LLC, (Westinghouse Parts Business), New Stanton, PA (DC, PO, PR)

### 03800 Analysis

- A Asbestos
- C Chemical
- FD Computational Fluid Dynamics (CFD)
- DE Design Basis
- DD Due Diligence
- ED Electrical Distribution Systems
- ET Electrical Transients
- EC Electronic Construction
- EL Elemental, Isotopic
- E Environmental
- EQ Equipment Qualification
- FE Failure, Electrical/Electronic
- FM Failure, Metallurgical
- FI Finite Element
- FR Fracture Mechanics
- FP Fuel Cycle & Fuel Performance
- G Geotechnical
- GM Groundwater Modeling
- HE Helium
- H Hydrological
- LA Laser-Based
- LP Loose Parts
- L Lubrication
- M Materials
- N Noise
- P Piping
- PP Plant Performance
- RL Reliability
- RE Resin, Ion Exchange
- RS Risk
- RC Root Cause
- SN Safety, Nuclear
- SP Safety, Plant
- SR Safety, Reactor
- SE Seismic
- SH Shielding
- SC Site Characterization
- SI Siting
- ST Stress
- SL Structural
- SS Sump/Strainer Blockage (Reg. Guide 1.82)
- T Thermal
- VC Vessel & Components Neutron Fluence
- V Vibration
- W Waste
- WA Water
- WH Water Hammer

- Advanced Consulting Group, Inc., Chicago, IL (FI, P, ST, SL)
- Advanced Cooling Technologies, Inc., Lancaster, PA (T)
- Advanced Technologies and Laboratories (ATL) International, Inc., (wholly owned sub. of Planned Systems International, Inc.), Gaithersburg, MD (E, RS, RC, SN, SR, SH, SC, W)
- F.N. Anderson & Assoc., Forest, VA (EL, E, EQ, FI, FP, P, PP, RL, SN, SR, SH, ST, SL)

- ANKUG Engineering Co., Ltd., Seoul, Korea (The Republic of) (SE)
- Applied Analysis Corp., Reading, PA (DE, EQ, SN, SR, SH, SI, T, WH)
- Applied Science Professionals, LLC, (ASP-LLC), Salt Lake City, UT (SC)
- ASI Marine, (ASI Group Ltd.), Orchard Park, NY (H, P)
- ASVAD INTL SL, Tarragona, Spain (SR)
- Attention IT, Inc., (Attention IT Ltd. (UK)), Knoxville, TN (E)
- Babcock Services, Inc., Kennewick, WA (SC, W)
- ◆ Banda Group International, LLC, Mesa, AZ (G, GM, RS, RC, SN, SP, SC)
- ◆ G.D. Barri & Associates, Inc., Peoria, AZ (DE, E, FE, G, H, M, SE, SH, SC, ST)
- ◆ Bechtel, (Bechtel Power), (Bechtel Nuclear Security & Environmental), (Bechtel National), Reston, VA (DE, ED, ET, EQ, P, SN, SP, SE, ST, SL, SS, T, WH)
- Bevelacqua Resources, (Radiation Protection), Owens Cross Roads, AL (E, RS, RC, SN, SR, SH)
- BHI Energy - now Westinghouse, See listing for Westinghouse Electric Co., Cranberry Township, PA (E, FE, P, RC, SC)
- Bilfinger Noell GmbH, (Dept. BEV), Wuerzburg, Germany (SE, ST)
- Black & Veatch, Overland Park, KS (C, DE, DD, ED, ET, E, EQ, G, H, N, P, PP, RL, RS, RC, SN, SP, SE, SH, SC, SI, ST, SL, T, WH)
- ◆ Boston Government Services, LLC (BGS), Oak Ridge, TN (DE, ED, EQ, FI, P, PP, RS, RC, SN, SP, SR, ST, SL, T, W)
- Burns & McDonnell, Kansas City, MO (FD, DE, DD, ED, ET, EC, E, EQ, FE, FM, FI, FR, G, H, M, P, PP, RL, RC, SN, SP, SR, SE, SH, SC, SI, ST, SL, SS, T, VC, V, W, WA, WH)
- BWX Technologies, Inc., Lynchburg, VA (C, DE, EL, E, FE, FM, FI, FR, FP, LP, M, N, P, RS, RC, SN, SP, SR, SE, SH, ST, SL, T, VC, V, W)
- Cabrera Services Inc., East Hartford, CT (EL, H, M, RS, SC)
- CAEN SyS, (CAEN SpA), Viareggio, LU, Italy (E, FP, SN, W, WA)
- Canoil Canada Ltd, Mississauga, Ontario, Canada (L)
- Centronic Ltd., Surrey, United Kingdom (E, EQ, FE, M, SN, SP, SR, SE, SH, ST, V)
- Consolidated Power Supply, (Div. of Consolidated Pipe & Supply Co., Inc.), Birmingham, AL (C, DE, FM, FR, M, P, SE, ST, SL)
- ◆ Constellation PowerLabs, Coatesville, PA (C, EL, E, EQ, FE, FM, FR, M, RC)
- Container Technologies Industries, LLC, Helenwood, TN (FI, M, RS, SH, ST)
- CPM Consulting, LLC, Huntsville, AL (RC)
- Croft Associates Ltd, Abingdon, Oxfordshire, United Kingdom (DE, FI)
- CS-2 Inc., Grand Island, NY (E, RS, RC, SP, SC, T, W)
- CTR Technical Services, Inc., Manitou Springs, CO (RS, SN, SR, SH)
- Curie Environmental Services, Albuquerque, NM (W)
- ◆ Curtiss-Wright Nuclear Division, Brea, CA (C, DE, DD, ED, ET, EL, E, EQ, FI, FR, FP, M, P, PP, RL, RS, RC, SN, SP, SR, SE, SH, SC, ST, SL, T, V)
- Curtiss-Wright Nuclear Division, Enertech, Brea, CA (DE, RS, SE)
- Curtiss-Wright Nuclear Division, NETCO, Danbury, CT (EL, T)
- Curtiss-Wright Nuclear Division, QualTech NP, Cincinnati, OH (DE, E, EQ, RL, SN, SE, SH, ST, SL, V)
- Curtiss-Wright Nuclear Division, Scientech, Idaho Falls, ID (C, DD, ED, ET, EQ, FI, FR, FP, M, P, PP, RL, RS, RC, SN, SP, SR, SE, SH, SC, ST, SL, T, V)
- DCS Systems, Inc., Simsbury, CT (FP, RC)
- Deytec, Inc., Ashburn, VA (RS, SN, SP, SR)
- DLE Technical Services, LLC, (BlueDragon Critical Thinking and Complex Problem Solving Workshops), Palm City, FL (PP, RC, SN, SP)
- ◆ Dominon Engineering, Inc., Reston, VA (C, FD, DE, EQ, FM, FI, FR, FP, H, M, P, PP, RL, RE, RS, RC, SN, SR, SE, SH, ST, SL, T, VC, W, WA, WH)

See advertisement on page 49

# NETZSCH

## Proven Excellence.



**NETZSCH** Instruments is the leading supplier of thermal analysis and thermophysical property instrumentation to the nuclear industry. Including robust modular instruments designed for **gloveboxes & hot cells.**



nib\_sales@  
netzsch.com  
(781)272-5353

- Dufrane Nuclear Shielding Inc., (Dufrane Nuclear Inc.), Winsted, CT (SH, W)  
DW James Consulting, LLC, North Oaks, MN (RE, SH, VC, W, WA)  
ECC, Burlingame, CA (E, G, SC)  
Elcometer, Inc., Warren, MI (E)  
Electrical Builders Inc. (EBI), St. Cloud, MN (FE)
- ◆ Element Nuclear (NTS Labs), (Nuclear Engineering & Test Services), Huntsville, AL (EQ, FI, M, T)  
EmmEn Marketing Consultants, Pune, Maharashtra, India (LP)  
Energy Resources International Inc., Washington, DC (FP, W)  
Energy Steel, Rochester Hills, MI (C, DE, EQ, FE, FM, FI, FR, FP, LP, L, M, P, RS, SE, SH, ST, SS, T, VC, V, WH)
  - ◆ EnergySolutions, Salt Lake City, UT (C, DE, EL, FM, M, RS, SN, SE, SH, SC, SI, ST, T, V, W)  
Equipos Nucleares, S.A., S.M.E. Maliaño (Cantabria), Spain (SL)  
ETAP - Operation Technology, Inc., Irvine, CA (DD, ED, ET, RL)  
Evident Scientific, Inc., (Evident Corp.), Webster, TX (E, FM, M)
  - ◆ EXCEL Services Corporation, Rockville, MD (DE, E, EQ, FI, FP, PP, RS, RC, SN, SP, SR, SH, SI, SL, T)
  - ◆ Framatome Inc., (North American Headquarters), Lynchburg, VA (C, DE, DD, ED, ET, EL, E, EQ, FE, FM, FI, FR, FP, LP, M, N, P, PP, RL, RE, RS, RC, SN, SP, SR, SE, SH, SC, ST, SL, SS, T, VC, V, W, WA, WH)  
Fuel Tank Maintenance Co., LLC, Cookeville, TN (FP)  
GE Hitachi Nuclear Energy, Wilmington, NC (DE, EL, EQ, FM, FP, M, P, PP, RL, RS, SR, SE, ST, SL, T, VC, V, WH)  
General Atomics Electromagnetic Systems, San Diego, CA (EQ)  
General Plastics Mfg. Co., Tacoma, WA (SN, W)  
Global Network of Companies LLC, Johannesburg, South Africa (SN)  
GLSEQ, LLC, Huntsville, AL (DE, ET, E, EQ, FE, LP, N, RC, SN, SE, V)  
GoldSim Technology Group, Seattle, WA (RS)  
GSE Engineering, Design & Analysis, (Formerly known as DP Engineering), Fort Worth, TX (DE, DD, ED, ET, EC, E, EQ, FE, FM, FP, P, PP, RS, SN, SP, SR, ST, SL, T, V, W, WA)  
GSE Engineering, Systems & Simulation, (GSE Systems), Columbia, MD (FP)  
GSE Solutions, (GSE Systems), Columbia, MD (ED, ET, EC, EL, E, EQ, FE, FP, P, PP, RS, RC, SN, SP, SR, T, VC, V, W, WA)  
Hayward Tyler Inc., Colchester, VT (DE, SE)
  - ◆ Holtec International, Camden, NJ (EQ, FI, P, SE, SH, ST, SL, T, V, WH)  
Hoskin Scientific, Oakville, Ontario, Canada (E, G, ST, SL, T)  
Hot Cell Services Corp., (HCS Corp.), Kent, WA (SH)  
Hydro, Inc., (HydroAire Services Division), Chicago, IL (FI, RC, ST, T, V)  
Idaho National Laboratory, Idaho Falls, ID (DE, RS, SN, SP, SR, SE, SH)  
Idom Consulting, Engineering, Architecture S.A.U., Bilbao, Spain (DE, DD, ED, FI, FR, G, M, P, RL, SN, SE, SH, SC, ST, SL, T, VC, WH)  
ILD, Inc., Baton Rouge, LA (P, PP, RC, SE, ST, T, V)  
Imperia Engineering Partners LLC, Milford, MA (DE, DD, E, EQ, FE, FM, FI, M, RS, SE, SI, ST, SS, T, V)  
Interdevelopment, Inc., Falls Church, VA (RS)  
Interface Analysis Centre, University of Bristol, Bristol, United Kingdom (EL, M)  
Intertek, Santa Clara, CA (DE, FM, FI, FR, M, P, PP, RL, RC, ST, SL, T)  
ISO-PACIFIC Remediation Technologies, Inc., Richland, WA (EL, SH)  
James Fisher Technologies, Loveland, CO (ED, FI, SC, ST, SL, W)  
Joseph Oat Corp., Camden, NJ (FI, H, M, ST, T, V, WH)  
KCI Engineering Consultants, Downers Grove, IL (ED, ET, EQ, FE, M, RC, ST, SL)
  - Kinectrics Inc., Toronto, Ontario, Canada (C, DE, DD, ED, ET, EL, E, EQ, FE, FM, FR, FP, H, LP, L, M, PP, RL, RE, RS, RC, SE, SH, SC, ST, SL, T, V, W, WA)  
Kinemetrics, Inc., Pasadena, CA (SE)  
LabLogic Systems, Inc., Chantilly, VA (SH)  
Laboratory Services, (Div. of Consumers Energy), Jackson, MI (C, E, EQ, FE, FM, M, ST)  
Lambda Technologies, (Surface Enhancement Technologies, LLC and Lambda Research, Inc.), Cincinnati, OH (FM, FI, RC, ST, SL)  
LATA, Albuquerque, NM (E, GM, H, RS, SN, SC, W)  
Lockton Insurance, Houston, TX (RS)  
Lucideon, Schenectady, NY (C, DE, EL, FE, FM, FI, FR, M, RL, RC, ST, T)  
MarShield Radiation Shielding, (Div. of Maxwell Metal Industries Ltd.), Burlington, Ontario, Canada (M, W)  
Materials and Chemistry Laboratory, Inc., (MCLinc), Oak Ridge, TN (A, C, DE, EL, E, FM, G, M, SN, SP, T, W, WA)  
Mechanical Solutions, Inc., Whippany, NJ (FD, FR, ST, V)  
Mega-Tech Services, LLC, Cooksburg, PA (RL, RS)  
Meridian Services Group, (formerly Work Management, Inc., and High Bridge Associates, Inc.), Chattanooga, TN (PP, RS, RC, SC)  
MillenniTEK, LLC, Knoxville, TN (C, EQ, SN, SH, T)  
Mirion Technologies, Inc., (Sensing Systems Div.), Atlanta, GA (SN, SP, SR, SH, W)  
Mitsubishi Nuclear Energy Systems, Inc., (A Sub. of Mitsubishi Heavy Industries, Ltd.), Charlotte, NC (C, DE, ED, ET, EC, EL, E, EQ, FE, FM, FI, FR, FP, G, HE, H, LP, L, M, N, P, PP, RL, RE, RS, RC, SN, SP, SR, SE, SH, SC, SI, ST, SL, SS, T, VC, V, W, WA, WH)
  - ◆ NAC International Inc., Peachtree Corners, GA (DE, EQ, FI, FP, SE, SH, ST, SL, T)  
NAC LPT LLC, Mars, PA (E, SC, W)  
Navarro, Oak Ridge, TN (G, RL, SN, SC, W, WA)  
Neptune and Company, Inc., Lakewood, CO (C, E, FI, GM, H, RS)
  - ◆ **Netzsch Instruments North America LLC, Burlington, MA (C, EL, FP, ST, T)**  
Nextteq International LLC, Tampa, FL (C)  
North Wind Group, Idaho Falls, ID (E, GM, SC, SI, W)  
NSL Analytical Services, Inc., Cleveland, OH (C, EL, FM, M, P, ST)  
NuclearConsultants.com, Ann Arbor, MI (FP, SN, SH)  
NuclearN, Phoenix, AZ (PP, RL, RS, RC, SN, SP, SR)  
Numerical Advisory Solutions, LLC, Cary, NC (DE, ED, ET, EQ, FE, FI, P, PP, RC, SN, SP, SE, ST, SL, SS, T, WH)  
NuSource LLC, Alexandria, VA (DE, FI, SE, SL, T)
  - ◆ Oak Ridge National Laboratory, Oak Ridge, TN (FD, DE, DD, FI, FR, FP, H, M, PP, RL, RS, RC, SN, SP, SR, SE, SH, SC, SI, T, VC, W)  
ORTEC, Oak Ridge, TN (EL, E, SC, W)  
Pajarito Scientific Corp., Santa Fe, NM (EL, SN, SH, SC)  
PAR Systems, LLC, Saint Paul, MN (EQ, FE, FM, SE, ST, SL)  
◆ Paragon Energy Solutions, (Paragon), Fort Worth, TX (DE, ED, E, EQ, FI, M, RL, RC, SE)  
Paschal Solutions, Inc., Knoxville, TN (DE, SN, SH)  
Paxton & Vierling Steel, Carter Lake, IA (SL)  
Pioneer Motor Bearing Co., Kings Mountain, NC (RC, V)  
Platom Oy, Mikkeli, Finland (PP, SN, SR)  
PMT Nuclear, Woodridge, IL (FI, SE, SL)  
Power & Energy Systems Services, Oradell, NJ (PP, T)  
◆ Precision Custom Components, LLC., (DC Fabricators), York, PA (DE, FM, FI, ST, T, V)  
◆ Preferred Engineering Corp., (Sub. of Preferred Utilities Mfg. Corp.), Danbury, CT (C, FI, M, SE)  
Premier Technology, Inc., Blackfoot, ID (M, SH, SL)  
PROTEM USA LLC, Evergreen, CO (P)  
R&G Laboratories, Inc., Tampa, FL (C, FP, L)

## ♦ Denotes advertiser—see Index to Advertisers on pages 8-14

- ♦ Radiation Safety & Control Services, Inc., Seabrook, NH (E, G, SN, SP, SR, SH, SC, W, WA)
- Red Wolf Associates, Cary, NC (C, DE, EL, EQ, FI, P, PP, RS, SN, SR, SH, ST, SS, T, WA, WH)
- REEL COH Inc., Canada (SE)
- Right Brain Sekurity, Oswego, IL (RS)
- Schulz Electric, Timken Power Systems, East Haven, CT (EQ, FE, M, SE, V)
- SIET, Piacenza, Italy (EQ, PP, SN, SP, SR, T, V, WA, WH)
- Sigma Science, Inc., Albuquerque, NM (E, RS, SN, SR, SH, W)
- SKODA JS a.s., Plzen, Bolevec, Czech Republic (The) (FI, FR, SN, SR, SE, ST)
- Howard L. Sobel, P.E., Oceanside, NY (FP, W)
- Southwest Research Institute, San Antonio, TX (C, DE, EL, E, EQ, FE, FM, FI, FR, FP, G, GM, H, L, M, RL, RS, SN, SR, SE, SH, SC, SI, ST, SL, SS, T, V, W)
- ♦SSM Industries, Inc., (Nuclear Div.), Pittsburgh, PA (SE, SL)
- Studs vik Scandpower Inc., Wilmington, NC (FP)
- Superconductivity Innovations, New Windsor, NY (DE, ET, FE, M, RL)
- Syscom Instruments S.A., Sainte-Croix, Switzerland (SE, SL)
- Technical Associates, (a Div. of US Nuclear Corp.), Canoga Park, CA (E, SN, W, WA)
- Teledyne Brown Engineering, Inc., Huntsville, AL (E, SC, W)
- TerranearPMC, LLC, Exton, PA (E, SC)
- Tetra Tech Inc., Richland, WA (A, C, DE, DD, ED, ET, EC, EL, E, EQ, FE, FM, FI, G, GM, HE, H, LP, L, M, N, P, PP, RL, RE, RS, RC, SN, SP, SR, SE, SH, SC, SI, ST, SL, T, V, W, WA, WH)
- The Delphi Groupe, Inc., Austin, TX (DE, E, RS, RC, SN)
- ♦Thermal Engineering International (TEI), Cerritos, CA (PP, T, V)
- Theseus Quality Assurance, LLC, Richland, WA (RC)
- TLG Services, LLC, (sub. of Entergy Corp.), Bridgewater, CT (SC)
- Toshiba America Energy Systems Corp., West Allis, WI (DE, EQ, FM, FI, FR, G, M, P, SN, SP, SR, SE, SH, ST, SL, T, V, WH)
- TransWare Enterprises Inc., St. Louis, MO (FI, FP, SH, T, VC)
- ♦Ultra Energy, (Weed Instrument), Round Rock, TX (PP, RL, SN, SP, SR)
- University of Bristol, (Interface Analysis Centre) (South West Nuclear Hub), Bristol, United Kingdom (C, EL, E, FM, FR, FP, LA, LP, M, RS, SC, ST, W)
- UxC, LLC, Roswell, GA (FP)
- Veolia Nuclear Solutions - Federal Services, Piketon, OH (C, SC, W)
- vgbe energy service GmbH, Essen, Germany (C, EQ, FM, L, P, SN, SP, WA)
- Volian Enterprises, Inc., Murrysville, PA (EQ, RC, T)
- Warrington, Inc., Pflugerville, TX (FP)
- Westinghouse Electric Co. LLC, Cranberry Township, PA (C, DE, EL, E, EQ, FE, FI, FR, FP, H, LP, L, M, P, PP, RL, RS, RC, SN, SP, SR, SE, SH, SC, ST, SL, T, VC, V, W, WH)
- ♦Westinghouse Electric Company LLC, (Westinghouse Parts Business), New Stanton, PA (E, EQ, SE)
- ♦WMG, Inc., Peekskill, NY (EL, SH, SC, W)
- Zachry Nuclear Engineering, Charlotte, NC (C, EL, FI, GM, SS)

**04000 Analyzers**

- A Air
- CA Coincidence & Anti-Coincidence
- D Density
- DH Dissolved Hydrogen
- DO Dissolved Oxygen
- E Effluent
- G Gas
- CG Gas, Containment
- H Hydrazine
- MP Multi-Parameter
- OG Off-Gas Hydrogen
- OX Oxygen
- PO Portable Multichannel
- PA Post-Accident Sampling (O2 & H2)
- PH Phosphorescence

- PM Pulse-Height, Multi-Channel
- PS Pulse-Height, Single-Channel
- SI Silica
- SL Sludge
- SO Sodium
- ST Steam
- TF Time-of-Flight
- TO Total Organic Carbon
- V Viscosity
- WG Waste-Gas, Oxygen & Hydrogen
- W Water
- Aquasol Corp., North Tonawanda, NY (OX)
- Automation Products, Inc., (Dynatrol Div.), Houston, TX (SL, W)
- ♦AVANTech, LLC, Columbia, SC (DO, E, OX, SI, SO, W)
- Berthold Technologies USA LLC, Oak Ridge, TN (A, E, G)
- Bertin Technologies, France (G, OX)
- ♦Bot Engineering Ltd, Campbellville, Ontario, Canada (A, CA, D, E, G, CG, PO, PM, PS, TO, W)
- BWX Technologies, Inc., Lynchburg, VA (SL, SO, ST, W)
- CAEN SyS, (CAEN SpA), Viareggio, LU, Italy (CA, E, PO, PS, SL, TF)
- ♦Curtiss-Wright Nuclear Division, Brea, CA (MP)
- Curtiss-Wright Nuclear Division, Scientech, Idaho Falls, ID (MP)
- Elcometer, Inc., Warren, MI (V)
- ♦EnergySolutions, Salt Lake City, UT (SL, W)
- ♦Framatome Inc., (North American Headquarters), Lynchburg, VA (OG, SL)
- GE Hitachi Nuclear Energy, Wilmington, NC (G, CG, OG, W)
- GLSEQ, LLC, Huntsville, AL (G, CG, OG, OX, PA, WG)
- ♦HI-Q Environmental Products Co., Inc., San Diego, CA (A)
- Hoskin Scientific, Oakville, Ontario, Canada (DO, V)
- Inert Corp., Amesbury, MA (OX, W)
- James Fisher Technologies, Loveland, CO (A, TF)
- Kinectrics Inc., Toronto, Ontario, Canada (G, W)
- KROHNE, (KROHNE Nuclear), Romans-sur-Isère, France (DO)
- LabLogic Systems, Inc., Chantilly, VA (W)
- ♦LND, Inc., Oceanside, NY (CA, MP)
- Ludlum Measurements, Inc., Sweetwater, TX (PS)
- M. Braun, Inc., Stratham, NH (OX, W)
- Martek Instruments, Inc., Raleigh, NC (MP, W)
- Mirion Technologies, Inc., (Sensing Systems Div.), Atlanta, GA (A, E, G, PS, ST, W)
- Mound Technical Solutions, Inc., Miamisburg, OH (A, G, CG)
- ♦Netzsch Instruments North America LLC, Burlington, MA (G)
- Nextteq International LLC, Tampa, FL (A, G, CG, H, OG, OX, W)
- ♦NUCON International, Inc., Columbus, OH (G)
- ORTEC, Oak Ridge, TN (CA, E, MP, PO, PM, PS)
- Pajarito Scientific Corp., Santa Fe, NM (OG)
- ♦Paragon Energy Solutions, (Paragon), Fort Worth, TX (PA)
- ♦Radiation Safety & Control Services, Inc., Seabrook, NH (PO, PM)
- Radiological Solutions Inc., Rockdale, IL (W)
- Scientific Sales, Inc., Oak Ridge, TN (A, DH, G, CG, OX, PO, PA)
- Technical Associates, (a Div. of US Nuclear Corp.), Canoga Park, CA (A, G)
- Teledyne Brown Engineering, Inc., Huntsville, AL (CG, OG, OX, PA, TO, WG)
- Toshiba America Energy Systems Corp., West Allis, WI (PA, PM, PS)
- Tyne USA Inc., Jacksonville, FL (A, D, DH, DO, E, G, CG, MP, OG, PO, PM, PS, ST, WG, W)
- ♦Ultra Energy, (Weed Instrument), Round Rock, TX (PM, PS)
- US Nuclear Corp., (Technical Associates Sub.), (Overhoff Technology Corp. Sub.), Canoga Park, CA (A, E, PM, PS, W)
- Warrington, Inc., Pflugerville, TX (PO, PM)
- ♦Westinghouse Electric Company LLC, (Westinghouse Parts Business), New Stanton, PA (G, CG)

**06790 Asbestos Abatement/Removal Products & Services**

- Advanced Nuclear LLC, Aston, PA
- ♦American DND Inc., Grand Island, NY
- Brandenburg Industrial Service Company, Bethlehem, PA
- CS-2 Inc., Grand Island, NY
- Desco Mfg. Co., Inc., Rancho Santa Margarita, CA
- Fuel Tank Maintenance Co., LLC, Cookeville, TN
- GEM Technologies, Inc., Knoxville, TN
- North Wind Group, Idaho Falls, ID
- Tetra Tech Inc., Richland, WA

**06820 Assay Equipment, Fuel**

- ♦Framatome Inc., (North American Headquarters), Lynchburg, VA
- Mirion Technologies (Canberra) Inc., Meriden, CT
- Pajarito Scientific Corp., Santa Fe, NM
- ♦Ultra Energy, (Weed Instrument), Round Rock, TX
- Warrington, Inc., Pflugerville, TX

**06840 Assay Services, Uranium Ore**

- Pajarito Scientific Corp., Santa Fe, NM

**06860 Audits**

- CC Chemical Control Programs
- FP Fire Protection
- FD Fitness-for-Duty
- QA Quality Assurance
- RA Radiation Protection
- RP Respiratory Protection
- SP Security Plan Efficiency
- S Security QA
- Adam Brown Consulting, Inc., Cary, IL (FP, QA)
- Advanced Technologies and Laboratories (ATL) International, Inc., (wholly owned sub. of Planned Systems International, Inc.), Gaithersburg, MD (RA)
- AECON-WACHS, (U.S. Div. of Aecon Nuclear), Jackson, SC (QA)
- F.N. Anderson & Assoc., Forest, VA (QA)
- ARES Security Corp., Vienna, VA (SP)
- Babcock Services, Inc., Kennewick, WA (RA)
- ♦Banda Group International, LLC, Mesa, AZ (CC, QA, RA, SP)
- ♦G.D. Barri & Associates, Inc., Peoria, AZ (FP, QA)
- Bevelacqua Resources, (Radiation Protection), Owens Cross Roads, AL (RA, RP)
- BHI Energy - now Westinghouse, See listing for Westinghouse Electric Co., Cranberry Township, PA (QA, RA, S)
- Black & Veatch, Overland Park, KS (QA)
- ♦Boston Government Services, LLC (BGS), Oak Ridge, TN (QA, S)
- Bureau Veritas Inspection and Insurance Co., (previously OneCIS Inspection and Insurance Co.), Lynn, MA (QA)
- Burns & McDonnell, Kansas City, MO (FP, QA, S)
- Cabrera Services Inc., East Hartford, CT (RA)
- CAEN SyS, (CAEN SpA), Viareggio, LU, Italy (RA)
- CS-2 Inc., Grand Island, NY (QA)
- ♦Curtiss-Wright Nuclear Division, Brea, CA (FP, QA)
- Curtiss-Wright Nuclear Division, QualTech NP, Cincinnati, OH (QA)
- Curtiss-Wright Nuclear Division, Scientech, Idaho Falls, ID (FP, QA)
- DCS Systems, Inc., Simsbury, CT (QA)
- Dufrane Nuclear Shielding Inc., (Dufrane Nuclear Inc.), Winsted, CT (CC, RA)
- DW James Consulting, LLC, North Oaks, MN (QA, RA)
- Dynatol International GmbH, Bassersdorf, Switzerland (QA)
- ♦EnergySolutions, Salt Lake City, UT (QA, RA)
- Environmental Restoration Group, Inc., Albuquerque, NM (RA)
- ♦EXCEL Services Corporation, Rockville, MD (QA, S)
- ♦Framatome Inc., (North American Headquarters), Lynchburg, VA (FP, QA, RA, S)

General Plastics Mfg. Co., Tacoma, WA (QA)  
 Global Quality Management Advisors,  
 Lynchburg, VA (FD, QA)  
 GLSEQ, LLC, Huntsville, AL (QA)  
 GSE Engineering, Design & Analysis,  
 (Formerly known as DP Engineering), Fort  
 Worth, TX (FP, QA, S)  
 Kinectrics Inc., Toronto, Ontario, Canada (CC,  
 FD, QA)  
 Klein Consulting LLC, Norwich, CT (QA)  
 LATA, Albuquerque, NM (QA, RA)  
 National Inspection & Consultants, Fort Myers,  
 FL (QA)  
 Nucleonova S.L., Valencia, Spain (QA)  
 Numerical Advisory Solutions, LLC, Cary, NC  
 (FP)  
 Pajarito Scientific Corp., Santa Fe, NM (QA,  
 RA)  
 ♦Paragon Energy Solutions, (Paragon), Fort  
 Worth, TX (QA)  
 PMT Nuclear, Woodridge, IL (QA)  
 Power Generation Integrated, (PGICL),  
 Etobicoke, Ontario, Canada (QA)  
 Preferred Quality Services, Inc., Jacksonville,  
 FL (FD, QA)  
 PTP Spent Fuel Services, LLC, Grand Island,  
 NY (QA)  
 ♦Radiation Safety & Control Services, Inc.,  
 Seabrook, NH (RA)  
 Right Brain Sekurity, Oswego, IL (S)  
 SIET, Piacenza, Italy (QA)  
 Sigma Science, Inc., Albuquerque, NM (FP, QA,  
 RA)  
 Howard L. Sobel, P.E., Oceanside, NY (QA)  
 Sonic Systems International, LLC, Houston, TX  
 (QA)  
 Southwest Research Institute, San Antonio, TX  
 (FP, QA, RA)  
 Success Staging International, LLC, Evans, GA  
 (S)  
 Tetra Tech Inc., Richland, WA (QA, RA)  
 The Delphi Groupe, Inc., Austin, TX (RA, RP)  
 Theseus Quality Assurance, LLC, Richland, WA  
 (QA)  
 Westinghouse Electric Co. LLC, Cranberry  
 Township, PA (QA, RA, S)

### 06870 Autoclaves

♦Dominion Engineering, Inc., Reston, VA  
 GE Hitachi Nuclear Energy, Wilmington, NC  
 Platom Oy, Mikkel, Finland  
 Scientific Sales, Inc., Oak Ridge, TN

### 06950 Bar-Coding Devices & Supplies

♦Alphasource, Inc., Philadelphia, PA  
 Attention IT, Inc., (Attention IT Ltd. (UK)),  
 Knoxville, TN  
 ♦Curtiss-Wright Nuclear Division, Brea, CA  
 Curtiss-Wright Nuclear Division, QualTech NP,  
 Cincinnati, OH  
 MarShield Radiation Shielding, (Div. of  
 Marswell Metal Industries Ltd.), Burlington,  
 Ontario, Canada

### 07040 Batteries, Standby

Basic E, Inc., Charlotte, VT  
 ♦Curtiss-Wright Nuclear Division, Brea, CA  
 Curtiss-Wright Nuclear Division, QualTech NP,  
 Cincinnati, OH  
 EnerSys, Reading, PA  
 GUTOR, Houston, TX  
 ♦Paragon Energy Solutions, (Paragon), Fort  
 Worth, TX  
 Scientific Sales, Inc., Oak Ridge, TN  
 Toshiba America Energy Systems Corp., West  
 Allis, WI  
 ♦Westinghouse Electric Company LLC,  
 (Westinghouse Parts Business), New Stanton,  
 PA

### 07060 Battery Capacity Test Equipment

GUTOR, Houston, TX  
 ♦Paragon Energy Solutions, (Paragon), Fort  
 Worth, TX  
 ♦Westinghouse Electric Company LLC,  
 (Westinghouse Parts Business), New Stanton,  
 PA

### 07070 Battery Chargers

Basic E, Inc., Charlotte, VT  
 ♦Curtiss-Wright Nuclear Division, Brea, CA  
 Curtiss-Wright Nuclear Division, QualTech NP,  
 Cincinnati, OH  
 GUTOR, Houston, TX  
 ♦Paragon Energy Solutions, (Paragon), Fort  
 Worth, TX  
 Schaefer Electronics, Inc., Hopkinton, MA  
 Scientific Sales, Inc., Oak Ridge, TN  
 ♦Westinghouse Electric Company LLC,  
 (Westinghouse Parts Business), New Stanton,  
 PA

### 07080 Battery Monitoring Systems

GUTOR, Houston, TX  
 ♦Paragon Energy Solutions, (Paragon), Fort  
 Worth, TX  
 ♦Westinghouse Electric Company LLC,  
 (Westinghouse Parts Business), New Stanton,  
 PA

### 07100 Bearings

Basic E, Inc., Charlotte, VT  
 DAEDONG Metal Industry Co., Ltd., Busan,  
 Korea (The Republic of)  
 ♦Element Nuclear (NTS Labs), (Nuclear  
 Engineering & Test Services), Huntsville, AL  
 Energy Steel, Rochester Hills, MI  
 ♦Paragon Energy Solutions, (Paragon), Fort  
 Worth, TX  
 Pioneer Motor Bearing Co., Kings Mountain,  
 NC  
 PMT Nuclear, Woodridge, IL  
 Schulz Electric, Timken Power Systems, East  
 Haven, CT  
 Scientific Sales, Inc., Oak Ridge, TN  
 Westinghouse Electric Co. LLC, Cranberry  
 Township, PA  
 ♦Westinghouse Electric Company LLC,  
 (Westinghouse Parts Business), New Stanton,  
 PA

### 07120 Bearings, Self-Lubricating

Basic E, Inc., Charlotte, VT  
 ♦Element Nuclear (NTS Labs), (Nuclear  
 Engineering & Test Services), Huntsville, AL  
 Energy Steel, Rochester Hills, MI  
 ♦Paragon Energy Solutions, (Paragon), Fort  
 Worth, TX  
 Pioneer Motor Bearing Co., Kings Mountain,  
 NC  
 PMT Nuclear, Woodridge, IL  
 Schulz Electric, Timken Power Systems, East  
 Haven, CT  
 Scientific Sales, Inc., Oak Ridge, TN  
 Westinghouse Electric Co. LLC, Cranberry  
 Township, PA  
 ♦Westinghouse Electric Company LLC,  
 (Westinghouse Parts Business), New Stanton,  
 PA

### 07200 Bellows, Metal

Carolina Fabricators, West Columbia, SC  
 Centronic Ltd., Surrey, United Kingdom  
 Electrical Builders Inc. (EBI), St. Cloud, MN  
 Energy Steel, Rochester Hills, MI  
 Joseph Oat Corp., Camden, NJ  
 ♦Paragon Energy Solutions, (Paragon), Fort  
 Worth, TX  
 Piping Technology & Products, Inc., Houston,  
 TX  
 PMT Nuclear, Woodridge, IL  
 Thorburn Flex Inc., Pointe-Claire, Quebec,  
 Canada  
 U.S. Bellows, Inc., (Sub. of Piping Technology &  
 Products, Inc.), Houston, TX  
 ♦Westinghouse Electric Company LLC,  
 (Westinghouse Parts Business), New Stanton,  
 PA

### 07310 Boilers

AECON-WACHS, (U.S. Div. of Aecon Nuclear),  
 Jackson, SC  
 Bureau Veritas Inspection and Insurance Co.,  
 (previously OneCIS Inspection and Insurance  
 Co.), Lynn, MA  
 GE Hitachi Nuclear Energy, Wilmington, NC

Heatric Division of Meggitt (UK) Ltd., Poole,  
 Dorset, United Kingdom  
 Integra Services Technologies Inc., Sarnia,  
 Ontario, Canada  
 PROTEM USA LLC, Evergreen, CO  
 Westinghouse Electric Co. LLC, Cranberry  
 Township, PA

### 07330 Bolts, Foundation

Carolina Fabricators, West Columbia, SC  
 Consolidated Power Supply, (Div. of  
 Consolidated Pipe & Supply Co., Inc.),  
 Birmingham, AL  
 ♦Curtiss-Wright Nuclear Division, Brea, CA  
 Curtiss-Wright Nuclear Division, Nova,  
 Middleburg Heights, OH  
 ♦DuBose National Energy Services, Inc.,  
 Clinton, NC  
 Joseph Oat Corp., Camden, NJ  
 Lincoln Structural Solutions, Louisville, NE  
 ♦Paragon Energy Solutions, (Paragon), Fort  
 Worth, TX  
 Paxton & Vierling Steel, Carter Lake, IA  
 ♦T&T Enterprises, Corona, CA  
 Tioga Pipe, Philadelphia, PA  
 Trust Manufacturing, LLC, Euclid, OH  
 TW Metals - Nuclear Materials Solutions,  
 Linden, MI  
 ♦Westinghouse Electric Company LLC,  
 (Westinghouse Parts Business), New Stanton,  
 PA

### 07340 Bolts, Turbine-Coupling

Carolina Fabricators, West Columbia, SC  
 ♦Curtiss-Wright Nuclear Division, Brea, CA  
 Curtiss-Wright Nuclear Division, Nova,  
 Middleburg Heights, OH  
 ♦DuBose National Energy Services, Inc.,  
 Clinton, NC  
 Integra Services Technologies Inc., Sarnia,  
 Ontario, Canada  
 Lincoln Structural Solutions, Louisville, NE  
 ♦T&T Enterprises, Corona, CA  
 Tioga Pipe, Philadelphia, PA  
 Trust Manufacturing, LLC, Euclid, OH  
 TW Metals - Nuclear Materials Solutions,  
 Linden, MI  
 ♦Westinghouse Electric Company LLC,  
 (Westinghouse Parts Business), New Stanton,  
 PA

### 07370 Bootings for Tongs

James Fisher Technologies, Loveland, CO  
 Walischmiller Engineering GmbH, Markdorf,  
 Baden-Wuerttemberg, Germany

### 07800 Brackets, Supports

CT Cable Tray Supports  
 I Instrument  
 M Manifold  
 V Valve  
 AECON-WACHS, (U.S. Div. of Aecon Nuclear),  
 Jackson, SC (CT, M, V)  
 Carolina Fabricators, West Columbia, SC (CT, I,  
 M, V)  
 ♦Curtiss-Wright Nuclear Division, Brea, CA (CT)  
 Curtiss-Wright Nuclear Division, Nova,  
 Middleburg Heights, OH (CT)  
 ♦DuBose National Energy Services, Inc.,  
 Clinton, NC (CT)  
 E.S. Fox Limited, Niagara Falls, Ontario,  
 Canada (CT)  
 ♦James C. White Company, Inc., Greenville, SC  
 (CT, I, M, V)  
 Lincoln Structural Solutions, Louisville, NE  
 (CT, I, M, V)  
 NuSource LLC, Alexandria, VA (CT, I, V)  
 ♦Paragon Energy Solutions, (Paragon), Fort  
 Worth, TX (CT, I, M, V)  
 PMT Nuclear, Woodridge, IL (CT)  
 Scientific Sales, Inc., Oak Ridge, TN (CT, I, M,  
 V)  
 ♦SSM Industries, Inc., (Nuclear Div.),  
 Pittsburgh, PA (CT)  
 ♦Westinghouse Electric Company LLC,  
 (Westinghouse Parts Business), New Stanton,  
 PA (CT, I, M, V)

♦ Denotes advertiser—see Index to Advertisers on pages 8–14

### 08000 Bubble Chambers

Mohawk Safety, Inc., Manchester, CT

### 08100 Buildings, Portable or Temporary

James Fisher Technologies, Loveland, CO  
Pajarito Scientific Corp., Santa Fe, NM

### 08400 Cabinets & Panels, Instrument

- ♦AVANTech, LLC, Columbia, SC
- Carolina Fabricators, West Columbia, SC
- ♦Curtiss-Wright Nuclear Division, Brea, CA
- Curtiss-Wright Nuclear Division, QualTech NP, Cincinnati, OH
- ♦Framatome Inc., (North American Headquarters), Lynchburg, VA
- ♦Fram Safety Products, Inc., Rock Hill, SC
- GE Hitachi Nuclear Energy, Wilmington, NC
- Mirion Technologies (MGPI H&B) GmbH, (Mirion Technologies), Munich, Germany
- NuSource LLC, Alexandria, VA
- ♦Paragon Energy Solutions, (Paragon), Fort Worth, TX
- Schulz Electric, Timken Power Systems, East Haven, CT
- Scientific Sales, Inc., Oak Ridge, TN
- Westinghouse Electric Co. LLC, Cranberry Township, PA
- ♦Westinghouse Electric Company LLC, (Westinghouse Parts Business), New Stanton, PA

### 08800 Cable, Electrical

- CO Coaxial
- C Control
- DC Data Communications
- FI Fiber Optic
- FR Flame-Resistant
- HT High-Temperature
- I Instrumentation
- MI Mineral-Insulated, Metal-Jacketed
- P Power
- PA Prefabricated Assemblies
- RR Radiation-Resistant
- R Repair, In-Site
- UC Umbilical Cord, Nuclear Grade (Robotic)
- U Underwater
- ♦AVANTech, LLC, Columbia, SC (C, DC, I, P)
- BIRNS, Inc., Oxnard, CA (PA)
- ♦Bot Engineering Ltd, Campbellville, Ontario, Canada (RR)
- C.J. Enterprises, (Div. of C.J. Instruments, Inc.), Tarzana, CA (HT, RR)
- CableLAN Nuclear, Fort Myers, FL (CO, C, DC, FI, FR, HT, I, MI, P, PA, RR)
- Centronic Ltd., Surrey, United Kingdom (CO, HT, MI, RR)
- CM Technologies Corp., Coraopolis, PA (I)
- Coastel Cable Tools, Inc., East Syracuse, NY (CO, C, DC, P, RR)
- ♦Curtiss-Wright Nuclear Division, Brea, CA (CO, C, FR, HT, I, MI, P, PA, RR, R)
- Curtiss-Wright Nuclear Division, QualTech NP, Cincinnati, OH (CO, C, FR, HT, I, MI, P, PA, RR, R)
- ♦Element Nuclear (NTS Labs), (Nuclear Engineering & Test Services), Huntsville, AL (RR)
- ♦Framatome Inc., (North American Headquarters), Lynchburg, VA (HT, I, MI, PA, RR)
- GE Hitachi Nuclear Energy, Wilmington, NC (CO, C, FR, HT, I, MI)
- General Plastics Mfg. Co., Tacoma, WA (FR, HT)
- Hoskin Scientific, Oakville, Ontario, Canada (C, I)
- ♦James C. White Company, Inc., Greenville, SC (I)
- James Fisher Technologies, Loveland, CO (PA, RR)
- Kanata Electronic Services Ltd., (Div. of Shawcor Ltd.), Toronto, Ontario, Canada (I, PA, RR)
- LEMO S.A., Ecublens, Switzerland (CO, DC, PA)

- Mirion Technologies (IST Canada) ULC, (Formerly Mirion Technologies (IST Canada) Inc.), Cambridge, Ontario, Canada (MI)
- ♦Mirion Technologies (IST) Corp., (Sensing Systems Div.), Horseheads, NY (CO, C, FR, HT, I, MI, PA, RR)
- Mirion Technologies (MGPI H&B) GmbH, (Mirion Technologies), Munich, Germany (CO, C, I, MI, RR)
- Mirion Technologies, Inc., (Sensing Systems Div.), Atlanta, GA (CO, C, FR, HT, I, MI, PA, RR)
- NuSource LLC, Alexandria, VA (CO, C, I)
- PAR Systems, LLC, Saint Paul, MN (RR, UC)
- ♦Paragon Energy Solutions, (Paragon), Fort Worth, TX (CO, C, FI, FR, HT, I, MI, P, PA, RR)
- ♦Photonis, Brive la Gaillarde Cedex, France (CO, HT, MI, RR)
- Premier Technology, Inc., Blackfoot, ID (PA)
- PROTEM USA LLC, Evergreen, CO (U)
- Prysmian North America, Highland Heights, KY (CO, C, DC, FR, I, P, RR)
- ♦Reef Industries, Inc., (Griffolyn, Div. of Reef Industries, Inc.), Houston, TX (FR, PA)
- Schulz Electric, Timken Power Systems, East Haven, CT (HT, RR)
- SERCO USA, Evergreen, CO (R)
- Sidus Solutions LLC, San Diego, CA (UC, U)
- Teledyne Brown Engineering, Inc., Huntsville, AL (CO, C, DC, I, U)
- THERMOCOAX Inc., Alpharetta, GA (CO, C, DC, FR, HT, I, MI, P, PA, RR)
- THERMOCOAX SAS, Caligny, France (CO, C, DC, FR, HT, I, MI, P, PA, RR)
- ♦Ultra Energy, (Weed Instrument), Round Rock, TX (HT, I, MI, RR)
- Westinghouse Electric Co. LLC, Cranberry Township, PA (I, PA)
- ♦Westinghouse Electric Company LLC, (Westinghouse Parts Business), New Stanton, PA (CO, C, DC, FR, HT, I, MI, P, PA, RR, R, UC, U)

### 09100 Cable, Fiber Optic

- CableLAN Nuclear, Fort Myers, FL
- ♦Curtiss-Wright Nuclear Division, Brea, CA
- Curtiss-Wright Nuclear Division, QualTech NP, Cincinnati, OH
- ♦James C. White Company, Inc., Greenville, SC
- Kinectrics Inc., Toronto, Ontario, Canada
- ♦Mirion Technologies (IST) Corp., (Sensing Systems Div.), Horseheads, NY
- Mirion Technologies, Inc., (Sensing Systems Div.), Atlanta, GA
- ♦Paragon Energy Solutions, (Paragon), Fort Worth, TX
- Prysmian Cables & Systems USA, LLC, Claremont, NC
- Prysmian North America, Highland Heights, KY
- Teledyne Brown Engineering, Inc., Huntsville, AL
- Thinklogical, A Belden Brand, Milford, CT
- ♦Ultra Energy, (Weed Instrument), Round Rock, TX
- ♦Westinghouse Electric Company LLC, (Westinghouse Parts Business), New Stanton, PA

### 09400 Cable Ties

- ♦Alphasource, Inc., Philadelphia, PA
- Basic E, Inc., Charlotte, VT
- ♦Fram Safety Products, Inc., Rock Hill, SC
- ♦Paragon Energy Solutions, (Paragon), Fort Worth, TX
- Tech Products, Inc., Staten Island, NY
- ♦Westinghouse Electric Company LLC, (Westinghouse Parts Business), New Stanton, PA

### 09550 Cable Wrap, Separation, Fire-Resistant

- ♦Fram Safety Products, Inc., Rock Hill, SC
- ♦Westinghouse Electric Company LLC, (Westinghouse Parts Business), New Stanton, PA

### 09730 Calciners

- ♦Framatome Inc., (North American Headquarters), Lynchburg, VA
- ISO-PACIFIC Remediation Technologies, Inc., Richland, WA
- Komline, Peapack, NJ
- Orano Federal Services, Charlotte, NC
- ♦Petersen Inc. (A Precinmac Company), Ogden, UT

### 09750 Calibration Equipment & Systems

- D Dose, Nuclear Medicine
- E Electrical Test Equipment
- ET Electronic Test Equipment
- IC Instrumentation & Control
- LF Laminar Flow
- P Pressure
- R Radiation Measuring
- Advanced Technologies and Laboratories (ATL) International, Inc., (wholly owned sub. of Planned Systems International, Inc.), Gaithersburg, MD (IC, R)
- Advetage Solutions, El Segundo, CA (D, R)
- Berthold Technologies USA LLC, Oak Ridge, TN (R)
- Bertin Technologies, France (D)
- ♦Bot Engineering Ltd, Campbellville, Ontario, Canada (IC, R)
- Cabrera Services Inc., East Hartford, CT (R)
- Centronic Ltd., Surrey, United Kingdom (R)
- CM Technologies Corp., Coraopolis, PA (E, ET, IC)
- Coastel Cable Tools, Inc., East Syracuse, NY (IC)
- ♦Constellation PowerLabs, Coatesville, PA (E, ET, IC, LF, P, R)
- ♦F&J SPECIALTY PRODUCTS, INC., Ocala, FL (ET, IC)
- ♦Framatome Inc., (North American Headquarters), Lynchburg, VA (D, IC, P, R)
- GE Hitachi Nuclear Energy, Wilmington, NC (E, IC)
- General Atomics Electromagnetic Systems, San Diego, CA (IC, R)
- ♦HI-Q Environmental Products Co., Inc., San Diego, CA (LF, R)
- Hopewell Designs, Inc., Alpharetta, GA (IC, R)
- Hoskin Scientific, Oakville, Ontario, Canada (IC, P)
- James Fisher Technologies, Loveland, CO (R)
- Kinectrics Inc., Toronto, Ontario, Canada (E, IC)
- KROHNE, (KROHNE Nuclear), Romans-sur-Isère, France (IC)
- Mirion Technologies (Canberra) Inc., Meriden, CT (E, IC, R)
- Mirion Technologies, Inc., (Sensing Systems Div.), Atlanta, GA (D, IC, R)
- North Wind Group, Idaho Falls, ID (R)
- ORTEC, Oak Ridge, TN (R)
- Perma-Fix Environmental Services, Inc., Oak Ridge, TN (R)
- ♦Radiation Safety & Control Services, Inc., Seabrook, NH (D, R)
- ♦RdF Corporation, Hudson, NH (IC)
- Rexon Components, Inc., Beachwood, OH (D, R)
- Scientific Sales, Inc., Oak Ridge, TN (D, E, ET, IC, LF, P, R)
- J. L. Shepherd & Assoc., San Fernando, CA (IC, R)
- Tyne USA Inc., Jacksonville, FL (ET, IC, P, R)
- US Nuclear Corp., (Technical Associates Sub.), (Overhoff Technology Corp. Sub.), Canoga Park, CA (D, R)

### 09800 Calibration Services

- E Electrical Test Equipment
- ET Electronic Test Equipment
- F Flow
- IC Instrumentation & Control
- PT Pressure, Temperature, Humidity
- R Radiation Measuring
- T Tools, Physical/Dimensional/Mechanical
- 3 Bears Technical Services, Hixson, TN (R)
- Advetage Solutions, El Segundo, CA (R)
- ANTECH Corp., Arvada, CO (R)

- ◆G.D. Barri & Associates, Inc., Peoria, AZ (IC)
- Berkeley Nucleonics Corp., San Rafael, CA (ET)
- Berthold Technologies USA LLC, Oak Ridge, TN (R)
- Bertin Technologies, France (R)
- BHI Energy - now Westinghouse, See listing for Westinghouse Electric Co., Cranberry Township, PA (IC)
- Cabrera Services Inc., East Hartford, CT (R)
- Centronic Ltd., Surrey, United Kingdom (E, ET, IC, PT, R, T)
- Coastel Cable Tools, Inc., East Syracuse, NY (ET)

◆**Constellation PowerLabs, Coatesville, PA (E, ET, F, IC, PT, R, T)**

- ◆Curtiss-Wright Nuclear Division, Brea, CA (F, IC, PT)
- Curtiss-Wright Nuclear Division, Enertech, Brea, CA (F, IC, PT)
- Eckert & Ziegler Analytics, Atlanta, GA (R)
- ◆Element Nuclear (NTS Labs), (Nuclear Engineering & Test Services), Huntsville, AL (E, ET, PT, T)
- ◆EnergySolutions, Salt Lake City, UT (IC, R)
- Environmental Restoration Group, Inc., Albuquerque, NM (R)
- ◆F&J SPECIALTY PRODUCTS, INC., Ocala, FL (F)
- FCI-Fluid Components International, San Marcos, CA (F)
- ◆Framatome Inc., (North American Headquarters), Lynchburg, VA (E, ET, IC, PT, R, T)
- GE Hitachi Nuclear Energy, Wilmington, NC (E, IC)
- General Atomics Electromagnetic Systems, San Diego, CA (ET, R)
- ◆HI-Q Environmental Products Co., Inc., San Diego, CA (F, R)
- Hopewell Designs, Inc., Alpharetta, GA (R, T)
- Hoskin Scientific, Oakville, Ontario, Canada (F, PT)
- James Fisher Technologies, Loveland, CO (R, T)
- Kinectrics Inc., Toronto, Ontario, Canada (E, ET, IC)
- Kinemetrics, Inc., Pasadena, CA (IC)
- KROHNE, (KROHNE Nuclear), Romans-sur-Isère, France (F, IC)
- LabLogic Systems, Inc., Chantilly, VA (R)
- Laboratory Services, (Div. of Consumers Energy), Jackson, MI (E, ET, F, IC, PT, T)
- Mirion Technologies (Canberra) Inc., Meriden, CT (R)
- Mirion Technologies, Inc., (Sensing Systems Div.), Atlanta, GA (IC, R)
- North Wind Group, Idaho Falls, ID (R)
- NSSI/Recovery Services Inc., Houston, TX (R)
- ◆NUCON International, Inc., Columbus, OH (E, ET, F, IC, PT, R, T)
- ORTEC, Oak Ridge, TN (R)
- Pajarito Scientific Corp., Santa Fe, NM (IC, R)
- Perma-Fix Environmental Services, Inc., Oak Ridge, TN (IC, PT, R)
- ◆Precision Custom Components, LLC., (DC Fabricators), York, PA (T)
- ◆**Radiation Safety & Control Services, Inc., Seabrook, NH (R)**

*See advertisement on cover 3*

- ◆RdF Corporation, Hudson, NH (IC, PT)
- SJET, Piacenza, Italy (E, ET, F, IC, PT, T)
- Southwest Research Institute, San Antonio, TX (E, ET, F, IC, PT, R, T)
- Technical Associates, (a Div. of US Nuclear Corp.), Canoga Park, CA (R)
- Tyne USA Inc., Jacksonville, FL (ET, F, IC, R, T)
- US Nuclear Corp., (Technical Associates Sub.), (Overhoff Technology Corp. Sub.), Canoga Park, CA (R)
- Veolia Nuclear Solutions - Federal Services, Piketon, OH (R)
- Warrington, Inc., Pflugerville, TX (R)
- Westinghouse Electric Co. LLC, Cranberry Township, PA (IC, T)

**09870 Calorimeters**

- ANTECH Corp., Arvada, CO
- ◆Netzsch Instruments North America LLC, Burlington, MA
- ◆RdF Corporation, Hudson, NH
- Scientific Sales, Inc., Oak Ridge, TN

**09875 Camera Systems, Motion Magnification**

Mechanical Solutions, Inc., Whippany, NJ

**09880 Camera Systems, Radiation-Hardened**

Advetage Solutions, El Segundo, CA

- ◆Ahlberg Cameras, Wilmington, NC
- ◆Dominion Engineering, Inc., Reston, VA
- Toshiba America Energy Systems Corp., West Allis, WI

**09900 Carbon, Activated**

Arkema, Inc., (formerly ATOFINA Chemicals, Inc.), King of Prussia, PA

- ◆AVANTech, LLC, Columbia, SC
- Camfil USA, Inc., Washington, NC
- ◆F&J SPECIALTY PRODUCTS, INC., Ocala, FL
- GE Hitachi Nuclear Energy, Wilmington, NC
- ◆HI-Q Environmental Products Co., Inc., San Diego, CA
- IONEX Research Corp., Lafayette, CO
- ◆NUCON International, Inc., Columbus, OH

**09950 Cars, Railroad**

CH Cask-Handling  
L Liners

- ◆Alphasource, Inc., Philadelphia, PA (L)
- ◆AVANTech, LLC, Columbia, SC (L)
- Dufrane Nuclear Shielding Inc., (Dufrane Nuclear Inc.), Winsted, CT (CH, L)
- ◆EnergySolutions, Salt Lake City, UT (L)
- ◆I.C.E. Service Group, Inc., Moon Township, PA (CH, L)
- Joseph Oat Corp., Camden, NJ (L)
- Konecranes Nuclear Equipment & Services LLC, (Formerly Morris Material Handling / P&H), New Berlin, WI (CH)
- NAC LPT LLC, Mars, PA (CH, L)
- Orano USA, Bethesda, MD (CH)
- ◆PacTec, Inc., Clinton, LA (L)
- REEL COH Inc., Canada (CH)

**10010 Casings, Primary Coolant Pump**

- ◆DuBose National Energy Services, Inc., Clinton, NC
- EmmEn Marketing Consultants, Pune, Maharashtra, India
- KSB, Inc., Henrico, VA
- ◆Major Tool & Machine, (A Precinmac Company), Indianapolis, IN
- ◆Precision Custom Components, LLC., (DC Fabricators), York, PA
- Westinghouse Electric Co. LLC, Cranberry Township, PA

**10100 Ceramic Products**

Centronic Ltd., Surrey, United Kingdom  
Electrical Builders Inc. (EBI), St. Cloud, MN  
Free Form Fibers, Saratoga Springs, NY  
MillenniTEK, LLC, Knoxville, TN

**10780 Cleaning Equipment**

A Abrasive  
CP Cavity Pool  
CS Chemical Services  
P Parts Washers  
PC Pipe Cleaning  
PW Pressure Washing  
R Robotic  
S Steam  
TC Tube Cleaning  
U Ultrasonic  
UW Underwater  
V Vacuum  
VB Vacuum Blasting, Abrasive  
WJ Water Jetting, High-Pressure  
WA Water Jetting, High-Pressure, Abrasive

- ◆Alphasource, Inc., Philadelphia, PA (A)
- ASI Marine, (ASI Group Ltd.), Orchard Park, NY (R, UW)
- ATS Industrial Automation, Inc. - Nuclear (UK), Blaby, Leicester, United Kingdom (PC, R)
- ATS Industrial Automation, Inc. Nuclear (Canada), Cambridge, Ontario, Canada (PC, R)
- ◆AVANTech, LLC, Columbia, SC (CP, P, R, UW, V)

Babcock Services, Inc., Kennewick, WA (A, CP)  
Beaudrey American Services, Loveland, CO (TC)  
BHI Energy - now Westinghouse, See listing for Westinghouse Electric Co., Cranberry Township, PA (A, CP, CS, P, PW, V, VB, WJ)  
Brokk AB, Skelleftea, Sweden (R)  
BWV Technologies, Inc., Lynchburg, VA (TC, WJ)  
Carolina Fabricators, West Columbia, SC (WJ, WA)  
Container Technologies Industries, LLC, Helenwood, TN (A)  
Desco Mfg. Co., Inc., Rancho Santa Margarita, CA (A, PC, PW, V)

- ◆Dominion Engineering, Inc., Reston, VA (CP, CS, P, PC, R, U, UW, V)
- ◆EnergySolutions, Salt Lake City, UT (CP, V)
- FEVDI Nuclear Decontamination, Corbas, France (U)
- ◆Framatome Inc., (North American Headquarters), Lynchburg, VA (A, CP, CS, PC, PW, R, TC, U, UW, WJ, WA)
- ◆Frham Safety Products, Inc., Rock Hill, SC (V, VB)
- GNS Gesellschaft fur Nuklear-Service mbH, Essen, Germany (UW)
- Goodway Technologies, Stamford, CT (CS, PC, PW, TC, V)
- Heat Exchanger Products Corp. (HEPCO), Hingham, MA (TC)
- Hennigan Engineering LLC, Hingham, MA (PC, PW, TC, WJ, WA)
- ISO-PACIFIC Remediation Technologies, Inc., Richland, WA (R)
- James Fisher Technologies, Loveland, CO (CP, PC, R, S, UW, V, VB, WJ, WA)
- KUKA Systems UK Ltd, Halesowen, West Midlands, United Kingdom (R)
- Master-Lee Engineered Products Inc., Latrobe, PA (TC, UW, V)
- Mitsubishi Nuclear Energy Systems, Inc., (A Sub. of Mitsubishi Heavy Industries, Ltd.), Charlotte, NC (A, CP, CS, P, PC, PW, R, S, TC, U, UW, V, VB, WJ, WA)
- NuVision-HWM, (Wälischmiller Engineering), Pittsburgh, PA (R)
- PAR Systems, LLC, Saint Paul, MN (R, WJ, WA)
- Paxton & Vierling Steel, Carter Lake, IA (A)
- Powerfect Service, Inc., Brick, NJ (PW, S, TC)
- PROTEM USA LLC, Evergreen, CO (PC, TC, UW)
- Radiation Protection Systems, (by Alpha Safety), Groton, CT (V)
- River Technologies, LLC, Forest, VA (A, CP, P, PC, PW, R, S, TC, UW, V, VB, WJ, WA)
- Scientific Sales, Inc., Oak Ridge, TN (P)
- Toshiba America Energy Systems Corp., West Allis, WI (PW, S, U, UW, WJ, WA)
- Tri Nuclear Corp., Troy, NY (CP, UW, V)
- ◆UniTech Services Group, Inc., (Div. of UniFirst Corp.), Longmeadow, MA (A, P, PW, VB, WJ)
- Veolia Nuclear Solutions - Federal Services, Piketon, OH (R, WJ)
- Walischmiller Engineering GmbH, Markdorf, Baden-Württemberg, Germany (R)
- Westinghouse Electric Co. LLC, Cranberry Township, PA (A, CP, CS, P, PW, U, UW, V, VB, WJ)

**10850 Clothing, Protective, Anti-Contamination**

BS Bubble Suits  
C Coveralls  
CL Coveralls, Lightweight, Breathable  
D Disposable  
DS Dissolvable  
G Gloves  
H Head Coverings  
L Lab Coats  
MG Modesty Garments, Lightweight, Breathable  
SP Scrub Shirts & Pants  
SC Shoe Covers  
S Soluble

Advetage Solutions, El Segundo, CA (D, G)  
Coastal Network, Inc, Charlottesville, VA (C, CL, D, G, L, SP, SC)



# Quality, Efficient & Reliable Calibration and Testing Services

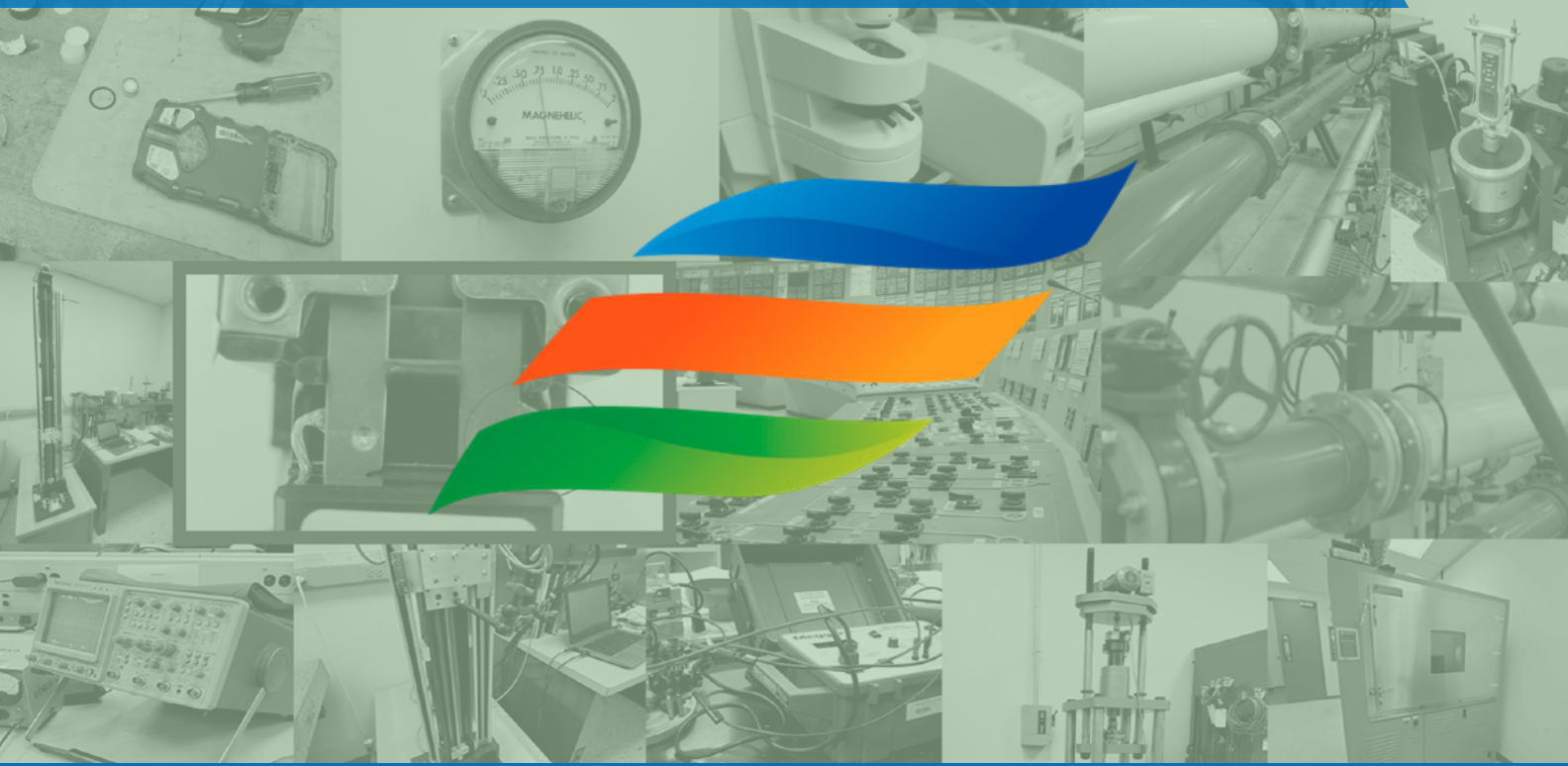

## WHY US?

Our wide-ranging measurement capabilities are enhanced with a scope that is A2LA Accredited to ISO 17025. Our Quality Program is routinely audited by NUPIC and NIAC, which satisfies the requirements of 10 CFR 50, Appendix B and 10 CFR 21. When you work with Constellation PowerLabs, you will receive the highest level of quality in the industry.

## OUR SERVICES



Failure Analysis



Flow Meter Calibrations



High Voltage Calibrations



Parts Quality Testing



CMM Inspection



Torque Wrenches, Transducers,  
Multipliers & Screwdrivers



Pressure Gauge Calibrations



Material Testing & Analysis



Chemical Analysis & Testing



1-Step Procurement

GET A QUOTE TODAY!



1-800-971-5227

PLSales@constellation.com

ConstellationPowerLabs.com



Constellation. PowerLabs

Eastern Technologies, Inc., (OREX; PolyZolv), Ashford, AL (C, CL, D, DS, G, H, L, MG, SP, SC, S)  
 Elcometer, Inc., Warren, MI (C, CL, G, H)  
 ♦EnergySolutions, Salt Lake City, UT (D)  
 FabOhio, Inc., Uhrichsville, OH (BS, C, D, H, L, SC)  
 ♦Frham Safety Products, Inc., Rock Hill, SC (BS, C, CL, D, DS, G, H, L, MG, SP, SC)  
 James Fisher Technologies, Loveland, CO (BS)  
 JSM Protective, Inc., Port St. Lucie, FL (BS, C, CL, D, G, H, L, MG, SP, SC)  
 Lanco Industries, Albuquerque, NM (BS, D, G, H, SC)  
 Mohawk Safety, Inc., Manchester, CT (C, CL, D, G, H, L, SC)  
 ♦Radiation Safety & Control Services, Inc., Seabrook, NH (C, D, G, H, SC)  
 Radium Inc., Waynesboro, VA (BS, D)  
 Rich Industries Inc., New Philadelphia, OH (BS, C, CL, D, G, H, L, MG, SP, SC)

Scientific Sales, Inc., Oak Ridge, TN (BS, C, CL, D, DS, G, H, L, MG, SP, SC, S)  
 Special Electronics & Designs Inc., (SED Inc.), Kincardine, Ontario, Canada (G)  
 UniTech Services Group Europe, (Sub. of UniTech Services Group USA), Coevorden, Netherlands (The) (BS, C, CL, D, G, H, L, MG, SP, SC)  
 ♦UniTech Services Group, Inc., (Div. of UniFirst Corp.), Longmeadow, MA (BS, C, CL, D, G, H, L, MG, SP, SC)  
 Weldstar, Aurora, IL (G)

GW Gloves, Welding  
 GS Goggles/Spectacles  
 HH Hard Hats  
 HL Hat Liners  
 HP Hearing Protection Devices  
 HF Helmets, Fire  
 LC Lab Coats  
 MG Modesty Garments, Lightweight, Breathable  
 RW Rainwear  
 RF RF Shielding  
 SC Scrub Suits  
 SS Splash Sleeves  
 V Vests, Cool

**10900 Clothing, Protective, Other Than Anti-Contamination**

B Bibs & Aprons  
 C Coveralls  
 CL Coveralls, Lightweight, Breathable  
 FS Face Shields  
 F Footwear  
 GG Gloves, Grinding

♦Alphasource, Inc., Philadelphia, PA (FS, GG, GW, GS, HH, HL, HP)  
 Coastal Network, Inc., Charlottesville, VA (FS, GS, HH, MG, RW, V)  
 Eastern Technologies, Inc., (OREX; PolyZolv), Ashford, AL (B, C, CL, FS, F, GG, GW, HL, LC, MG, RW, SC, SS, V)  
 EK USA, Inc., (EK Ekcessories, Inc.), Logan, UT (GS)  
 Elcometer, Inc., Warren, MI (B, C, CL)  
 FabOhio, Inc., Uhrichsville, OH (B, C, F, RW, SS, V)  
 ♦Frham Safety Products, Inc., Rock Hill, SC (B, C, CL, FS, F, GG, GW, GS, HH, HL, HP, HF, LC, MG, RW, RF, SC, SS, V)  
 JSM Protective, Inc., Port St. Lucie, FL (B, C, CL, FS, F, GG, GW, GS, HH, HL, HP, HF, LC, MG, RW, RF, SC, SS, V)  
 Lanco Industries, Albuquerque, NM (F, RW)  
 MarShield Radiation Shielding, (Div. of Marswell Metal Industries Ltd.), Burlington, Ontario, Canada (RF)  
 Mohawk Safety, Inc., Manchester, CT (C, CL, FS, F, GG, GW, GS, HH, HL, HP, LC, RW)  
 Radium Inc., Waynesboro, VA (FS, V)  
 Rich Industries Inc., New Philadelphia, OH (B, C, CL, F, HL, LC, RW, SC, SS, V)  
 Scientific Sales, Inc., Oak Ridge, TN (B, C, CL, FS, F, GG, GW, GS, HH, HL, HP, HF, LC, MG, RW, RF, SC, SS, V)  
 UniTech Services Group Europe, (Sub. of UniTech Services Group USA), Coevorden, Netherlands (The) (B, C, CL, FS, F, GG, GW, GS, HH, HL, HP, HF, LC, MG, RW, RF, SC, SS, V)  
 ♦UniTech Services Group, Inc., (Div. of UniFirst Corp.), Longmeadow, MA (B, C, F, RF, V)  
 Weldstar, Aurora, IL (FS, GW, HH)

**11400 Coatings**

C Cable  
 CS Concrete Sealing/Restoration/Contamination Control  
 CR Corrosion-Resistant  
 FT Floor Toppings  
 IR Insulation-Related  
 LC Low-Chloride  
 S Strippable

Advanced Nuclear LLC, Aston, PA (IR)  
 Alaron Nuclear Services, (Veolia Nuclear Solutions Federal Services - Alaron), Wampum, PA (CR)  
 Arkema, Inc., (formerly ATOFINA Chemicals, Inc.), King of Prussia, PA (CS, CR, IR)  
 Bakelite Synthetics, Atlanta, GA (CS, CR, IR)  
 BHI Energy - now Westinghouse, See listing for Westinghouse Electric Co., Cranberry Township, PA (CS, CR, FT, S)  
 Carolina Fabricators, West Columbia, SC (CR)  
 Concurrent Technologies Corporation, (Center for Advanced Nuclear Manufacturing), Johnstown, PA (CR, IR, LC, S)  
 Consolidated Power Supply, (Div. of Consolidated Pipe & Supply Co., Inc.), Birmingham, AL (C, CR)  
 Cortec Corp., Saint Paul, MN (CS, CR, S)  
 EmmEn Marketing Consultants, Pune, Maharashtra, India (FT)  
 FEVDI Nuclear Decontamination, Corbas, France (S)  
 ♦Framatome Inc., (North American Headquarters), Lynchburg, VA (CS, CR, IR)  
 ♦Frham Safety Products, Inc., Rock Hill, SC (S)  
 Fuel Tank Maintenance Co., LLC, Cookeville, TN (CS, CR, FT)

**WE'RE MORE THAN JUST "THE LAUNDRY GUYS."**

**UniTech Services Group**

For decades, we were "the laundry guys". As customer needs have evolved, we've expanded our core service capabilities to meet industry demands, including:

- NUCLEAR PROTECTIVE CLOTHING
- TOOL AND METAL DECONTAMINATION
- RADIOACTIVE WASTE DISPOSAL
- NUCLEAR DECOMMISSIONING
- GOVERNMENT NUCLEAR SERVICES
- ON-SITE LABOR SERVICES
- JUST-IN-TIME NUCLEAR INVENTORY
- RESPIRATOR CLEANING & SALES

**CONTACT US AT: [www.unitechus.com](http://www.unitechus.com)**

◆ Denotes advertiser—see Index to Advertisers on pages 8-14

GE Hitachi Nuclear Energy, Wilmington, NC (CR)  
 General Magnaplate Corp., Arlington, TX (CR)  
 Hennigan Engineering LLC, Hingham, MA (CS, CR, S)  
 Hexion Inc., Columbus, OH (CS, CR, IR)  
 Paxton & Vierling Steel, Carter Lake, IA (CR, IR)  
 Plastacor, Inc., Hingham, MA (CR)  
 ◆ Reef Industries, Inc., (Griffolyn, Div. of Reef Industries, Inc.), Houston, TX (FT)  
 Southwest Research Institute, San Antonio, TX (CR, IR)  
 Toshiba America Energy Systems Corp., West Allis, WI (CR)  
 Westinghouse Electric Co. LLC, Cranberry Township, PA (CS, CR, FT, S)  
 Westlake Epoxy Inc., a Westlake Company, Stafford, TX (C, CS, CR, IR)

**11600 Columns, Processing**

Joseph Oat Corp., Camden, NJ  
 Paxton & Vierling Steel, Carter Lake, IA  
 ◆ Precision Custom Components, LLC., (DC Fabricators), York, PA  
 Rousselet-Robatel, Pittsfield, MA  
 Westinghouse Electric Co. LLC, Cranberry Township, PA

**11650 Communication Systems**

F Face Mask Accessories  
 H Headsets  
 P Paging  
 RM Repeated Message Tape/Speaker Boxes  
 T Telephone Conferencing (Audio)  
 TV Telephone Conferencing (Video)  
 T Telephonic (Computerized Calling/Answering)  
 TW Two-Way Radio  
 Basic E, Inc., Charlotte, VT (H, TW)  
 BHI Energy - now Westinghouse, See listing for Westinghouse Electric Co., Cranberry Township, PA (H, P, TW)  
 Comtronics, Lexington, KY (F, H, T, TV, TW)

Dufrane Nuclear Shielding Inc., (Dufrane Nuclear Inc.), Winsted, CT (H, T, TW)  
 ◆ Frham Safety Products, Inc., Rock Hill, SC (F, H)  
 ILSHINEDI Co., Ltd., Gyeongju-si, Korea (The Republic of) (P)  
 Radium Inc., Waynesboro, VA (H)  
 Scientific Sales, Inc., Oak Ridge, TN (F, H, TW)  
 Special Electronics & Designs Inc., (SED Inc.), Kincardine, Ontario, Canada (H, TW)  
 Westinghouse Electric Co. LLC, Cranberry Township, PA (H, P, TW)

**11680 Compactor Disks, for Drums**

S&G Enterprises, Inc., Germantown, WI

**11700 Compactors**

ATS Industrial Automation, Inc. - Nuclear (UK), Blaby, Leicester, United Kingdom  
 ATS Industrial Automation, Inc. Nuclear (Canada), Cambridge, Ontario, Canada  
 Bilfinger Noell GmbH, (Dept. BEV), Wuerzburg, Germany  
 Container Products Corporation, Wilmington, NC  
 ◆ Framatome Inc., (North American Headquarters), Lynchburg, VA  
 S&G Enterprises, Inc., Germantown, WI  
 Waste Control Systems, Inc., Phoenix, MD

**12100 Compressors, Refrigerant**

C Centrifugal  
 R Reciprocating  
 SD Screw-Driven  
 S Scroll  
 ◆ Curtiss-Wright Nuclear Division, Brea, CA (C, R, SD)  
 Curtiss-Wright Nuclear Division, QualTech NP, Cincinnati, OH (C, R, SD)  
 Ellis & Watts Global Industries, Inc., (a sub. of Marmon\*, a Berkshire Hathaway company), Batavia, OH (C, R, SD, S)  
 ◆ Paragon Energy Solutions, (Paragon), Fort Worth, TX (C, R, SD, S)

PMT Nuclear, Woodridge, IL (C, R, SD, S)  
 ◆ Westinghouse Electric Company LLC, (Westinghouse Parts Business), New Stanton, PA (C, R, SD, S)

**12720 Computer & Cyber Security**

BHI Energy - now Westinghouse, See listing for Westinghouse Electric Co., Cranberry Township, PA  
 Burns & McDonnell, Kansas City, MO  
 Concurrent Technologies Corporation, (Center for Advanced Nuclear Manufacturing), Johnstown, PA  
 ◆ EXCEL Services Corporation, Rockville, MD  
 ◆ Framatome Inc., (North American Headquarters), Lynchburg, VA  
 GSE Workforce Solutions, Training Services, (Formerly known as Hyperspring), Columbia, MD  
 Navarro, Oak Ridge, TN  
 Numerical Advisory Solutions, LLC, Cary, NC  
 ◆ Paragon Energy Solutions, (Paragon), Fort Worth, TX  
 Southwest Research Institute, San Antonio, TX  
 Success Staging International, LLC, Evans, GA  
 Theseus Quality Assurance, LLC, Richland, WA  
 TradeWind Services LLC, Richland, WA  
 ◆ Ultra Energy, (Weed Instrument), Round Rock, TX  
 University of Bristol, (Interface Analysis Centre) (South West Nuclear Hub), Bristol, United Kingdom  
 Westinghouse Electric Co. LLC, Cranberry Township, PA

**12750 Computer Services**

CA Computer-Aided Design  
 CS Computer-Aided Software Engineering  
 CP Computer Procurement Assistance  
 DC Data Collection, Acquisition  
 IC Installation/Changeout  
 N Network Services  
 PP Procedures Preparation







**FRHAM**  
Safety Products, Inc.

Providing products and services that improve safety and productivity in the industrial and nuclear industries.

Nashville, TN - 615.254.0841  
 Rock Hill, SC - 803.366.5131  
 www.frhamsafety.com

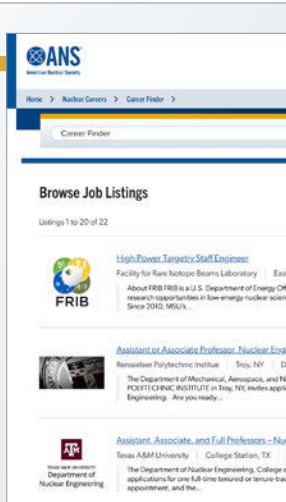
**PROMOTE**  
your **JOB**  
**LISTINGS**  
with 



Recruiting and hiring the best talent are significant challenges for many organizations right now. To further assist with your search and help set yourself apart in this competitive market, ANS is pleased to offer premier online job listings! Premier credits include a company logo next to your listing, keeps your posting near the top of the job board, and a link to your posting is included in a monthly email to ANS membership.

▶ Visit [www.ans.org/careers/finder](http://www.ans.org/careers/finder) to post today.

PM Project Management  
 QA Quality Assurance  
 SS Software Safety  
 SD Specifications Development  
 F.N. Anderson & Assoc., Forest, VA (CA, CS, CP, DC, IC, N, PP, PM, QA, SD)  
 Applied Analysis Corp., Reading, PA (QA, SS, SD)  
 Attention IT, Inc., (Attention IT Ltd. (UK)), Knoxville, TN (DC, PP, PM, QA, SS, SD)  
 BHI Energy - now Westinghouse, See listing for Westinghouse Electric Co., Cranberry Township, PA (CA, CS, IC, PM, QA)  
 Black & Veatch, Overland Park, KS (CA, DC, PM, QA)  
 ♦ Boston Government Services, LLC (BGS), Oak Ridge, TN (N, PP, PM, QA, SS, SD)  
 Burns & McDonnell, Kansas City, MO (CA, CS, CP, DC, IC, N, PP, PM, QA, SS, SD)  
 BWX Technologies, Inc., Lynchburg, VA (CA, DC)  
 CM Technologies Corp., Coraopolis, PA (DC)  
 Computer Engineering Services, Inc., Chattanooga, TN (CP, DC, IC, N, PP, PM, QA, SD)  
 Consolidated Power Supply, (Div. of Consolidated Pipe & Supply Co., Inc.), Birmingham, AL (CA, CS, PM)  
 CTR Technical Services, Inc., Manitou Springs, CO (DC, SD)  
 Curtiss-Wright Nuclear Division, Scientech, Idaho Falls, ID (CA, CP, DC, IC, N, PP, QA, SD)  
 DCS Systems, Inc., Simsbury, CT (PP, PM, QA, SD)  
 EmmEn Marketing Consultants, Pune, Maharashtra, India (CP)  
 Encorus Group, Springville, NY (CA)  
 Environmental Restoration Group, Inc., Albuquerque, NM (DC)  
 ETAP - Operation Technology, Inc., Irvine, CA (CA, CS, DC)  
 ♦ Framatome Inc., (North American Headquarters), Lynchburg, VA (CA, CP, DC, N, PM, QA)  
 GE Hitachi Nuclear Energy, Wilmington, NC (CA, CS, DC, IC, PM, QA, SD)  
 General Atomics Electromagnetic Systems, San Diego, CA (DC, PP, SD)  
 GSE Workforce Solutions, Training Services, (Formerly known as Hyperspring), Columbia, MD (CP, PM, QA)  
 HGP Inc., Greenville, SC (PM)  
 Hydro, Inc., (HydroAire Services Division), Chicago, IL (CA)  
 Imperia Engineering Partners LLC, Milford, MA (CA, PM)  
 In-Place Machining Company, LLC, Blue Ash, OH (CA, CS)  
 InfoTech NorthStar, Richland, WA (QA)  
 InVizion LLC, Oak Ridge, TN (PM)  
 Knowledge Relay, Cypress, CA (PM)  
 M. Braun, Inc., Stratham, NH (CA, CS, PM)  
 Merrick & Company, Greenwood Village, CO (CA)  
 MillenniTEK, LLC, Knoxville, TN (CA, DC, PM)  
 Mitsubishi Nuclear Energy Systems, Inc., (A Sub. of Mitsubishi Heavy Industries, Ltd.), Charlotte, NC (CA, CS, CP, DC, IC, N, PP, PM, QA, SS, SD)  
 Navarro, Oak Ridge, TN (DC, N, PM, QA)  
 NextAxiom Technology, Inc., San Francisco, CA (PP, SD)  
 Nuclear-21, Waasmunster, Belgium (PM)  
 NuclearN, Phoenix, AZ (CP, DC, PP, PM, QA)  
 Numerical Advisory Solutions, LLC, Cary, NC (CA, IC, PM, SD)  
 Pajarito Scientific Corp., Santa Fe, NM (DC, QA)  
 PAR Systems, LLC, Saint Paul, MN (CA)  
 ♦ Paragon Energy Solutions, (Paragon), Fort Worth, TX (QA)  
 Radiation Protection Systems, (by Alpha Safety), Groton, CT (CA)  
 Red Wolf Associates, Cary, NC (QA)  
 Howard L. Sobel, P.E., Oceanside, NY (PP, QA)  
 Standish Technologies International, Export, PA (SD)  
 Success Staging International, LLC, Evans, GA (CS, DC, PM, SD)  
 Tetra Tech Inc., Richland, WA (CA, CS, DC, PP, PM, QA)

Theseus Quality Assurance, LLC, Richland, WA (PP, QA)  
 Toshiba America Energy Systems Corp., West Allis, WI (CA, DC, IC, PP, PM, QA, SS, SD)  
 TRAD - RayXpert, Labège cedex, France (CA, SS)  
 TradeWind Services LLC, Richland, WA (CA, CS, CP, N, PP, PM, QA, SS, SD)  
 ♦ Ultra Energy, (Weed Instrument), Round Rock, TX (SD)  
 VAT Group, San Jose, CA (QA)  
 Volian Enterprises, Inc., Murrysville, PA (PP)  
 ♦ Wagstaff Applied Technologies, Spokane, WA (CA)  
 Westinghouse Electric Co. LLC, Cranberry Township, PA (CA, CS, IC, PM, QA)  
 ♦ WMG, Inc., Peekskill, NY (CA, CS, QA, SD)

## 12800 Computer Software

AI Artificial Intelligence  
 CB Cable Management  
 CW Component Wear Detection  
 CF Configuration Management/Control  
 CM Construction Management  
 CA Contract Administration  
 CT Core/Thermalhydraulics  
 CR Corrective Action Tracking  
 CP Critical Path Scheduling  
 CD Custom Development  
 DB Data Base Management  
 DM Decontamination Management  
 D Dosimetry  
 DD Drawing & Document Control  
 EC Economic Analysis  
 ET Education/Training  
 E Electrical Analysis  
 EP Emergency Planning  
 ER Emergency Response (In-Plant)  
 EA Engineering Analysis  
 EG Engineering Management  
 EM Environmental Monitoring  
 EQ Equipment Status/Tagout Tracking  
 ES Expert Systems  
 FT Fault-Tolerant Automatic Control  
 FR Failure/Root Cause Trending  
 FS Fire/Safety  
 FA Fuel Accounting  
 FP Fuel Performance/Management  
 HX Heat Exchanger Modeling  
 IS In-Service Inspection  
 IN Instrument Calibration  
 IC Inventory Control (Equipment, Supplies, etc.)  
 MC Maintenance Control  
 M Management (Station)  
 OS Operator Scheduling  
 P Piping System Design & Analysis  
 PD Plant Design  
 PP Plant Performance  
 PS Procedure Status/Tracking  
 PM Project Management  
 QA Quality Assurance/Quality Control  
 RC Radiological Control/Health Physics  
 R Reliability Analysis  
 RE Reportability Evaluation  
 RI Risk Analysis  
 RO Root Cause Analysis  
 SE Security  
 SI Simulation  
 SM Software Maintenance/Control  
 SP Software Packages  
 SN Special Nuclear Material Tracking  
 S Spectroscopy  
 TS Technical Specification Systems  
 TE Telerobotics  
 TR Trending  
 VP Valve Performance Prediction  
 V Verification & Validation  
 WM Waste Management  
 WC Water Chemistry Management  
 3D PLUS, (Detection Systems), Versailles, France (AI, D, S)  
 ABB Inc., Cary, NC (CR, EQ, FR, FS, IS, IC, MC, PP, R, RO)  
 Advanced Technologies and Laboratories (ATL) International, Inc., (wholly owned sub. of Planned Systems International, Inc.), Gaithersburg, MD (DM, EM)  
 Advetage Solutions, El Segundo, CA (CD, D, RC)

♦ Alphasource, Inc., Philadelphia, PA (IC, MC)  
 Applied Analysis Corp., Reading, PA (CD, EA, HX, P, QA, SI, SM, V)  
 ARES Security Corp., Vienna, VA (AI, EP, ER, SE, SI, TE)  
 Arkitek Scientific, Paso Robles, CA (ET)  
 ATS Industrial Automation, Inc. - Nuclear (UK), Blaby, Leicester, United Kingdom (TE, WM)  
 ATS Industrial Automation, Inc. Nuclear (Canada), Cambridge, Ontario, Canada (TE, WM)  
 Attention IT, Inc., (Attention IT Ltd. (UK)), Knoxville, TN (CF, CA, CD, DB, DM, DD, ET, IC, PS, PM, QA, SM, SP, SN, TS, WM)  
 Aurum Technologies, Blackfoot, ID (AI, CD, D, ET, ER, EM, EQ, IN, PM, RC, SP)  
 ♦ AVANTech, LLC, Columbia, SC (EA, WM, WC)  
 ♦ Banda Group International, LLC, Mesa, AZ (CA, PM, QA)  
 ♦ Bechtel, (Bechtel Power), (Bechtel Nuclear, Security & Environmental), (Bechtel National), Reston, VA (P, PD)  
 Berthold Technologies USA LLC, Oak Ridge, TN (RC)  
 Bertin Technologies, France (D, EM, RC)  
 Bevelacqua Resources, (Radiation Protection), Owens Cross Roads, AL (DM, D, ET, EP, ER, EM, RC, RI, RO, SI, SM, SP, SN, S)  
 BHI Energy - now Westinghouse, See listing for Westinghouse Electric Co., Cranberry Township, PA (CD, D, RC, SP, V)  
 Black & Veatch, Overland Park, KS (CF, CM, CA, CP, DB, DD, EC, E, EA, EQ, FS, HX, P, PD, PP, PM, QA, R)  
 BNF Technology Inc., Daejeon, Korea (The Republic of) (SM, SP)  
 ♦ Boston Government Services, LLC (BGS), Oak Ridge, TN (CF, CP, CD, DB, DD, ET, E, EP, EA, P, PD, PM, QA, R, RI, SE, SI, SM, SP, SN, WM)  
 BWX Technologies, Inc., Lynchburg, VA (AI, DB, ET, EA, IS)  
 CAEN SyS, (CAEN SpA), Viareggio, LU, Italy (SN, S, WM)  
 Campoverde srl, Milano, Italy (D)  
 Chesapeake Nuclear Services, Inc., Annapolis, MD (EM, RC)  
 CM Technologies Corp., Coraopolis, PA (ES, QA)  
 Coastel Cable Tools, Inc., East Syracuse, NY (IN, MC)  
 Computer Engineering Services, Inc., Chattanooga, TN (CD, ER, EA, EM, V)  
 Cragg Consulting, Grapevine, TX (RI)  
 CTR Technical Services, Inc., Manitou Springs, CO (CD, EA, FP, RI, SI, SP)  
 ♦ Curtiss-Wright Nuclear Division, Brea, CA (CF, CT, CD, DB, D, EP, EA, EQ, FR, FS, FP, IC, MC, P, PP, PM, R, RI, SE, SP, SN, TS, TR, WC)  
 Curtiss-Wright Nuclear Division, NETCO, Danbury, CT (CT, CD, DB, EA, FP, PP, SP)  
 Curtiss-Wright Nuclear Division, Scientech, Idaho Falls, ID (CF, CT, CD, DB, D, EP, EA, EQ, FR, FS, FP, IC, MC, P, PP, PM, R, RI, SE, SP, SN, TS, TR, WC)  
 DCS Systems, Inc., Simsbury, CT (CD, DB, EA, FA, FP, QA, V)  
 Deytec, Inc., Ashburn, VA (ET, EA, FS, RI, SI, V)  
 ♦ Dominion Engineering, Inc., Reston, VA (CD, EA, PP, RC, WC)  
 DW James Consulting, LLC, North Oaks, MN (PP, RC, SP, WM, WC)  
 Ebersen, Inc., Minneapolis, MN (WM)  
 ♦ Element Nuclear (NTS Labs), (Nuclear Engineering & Test Services), Huntsville, AL (V)  
 EmmEn Marketing Consultants, Pune, Maharashtra, India (SP)  
 Energy Resources International Inc., Washington, DC (CD, FA)  
 ENVINET GmbH, Munich/Haar, Germany (EM, SP)  
 Environmental Restoration Group, Inc., Albuquerque, NM (RC)  
 ETAP - Operation Technology, Inc., Irvine, CA (CB, ET, E, R, SI)  
 F.E. Moran Special Hazard Systems, Northbrook, IL (FS)

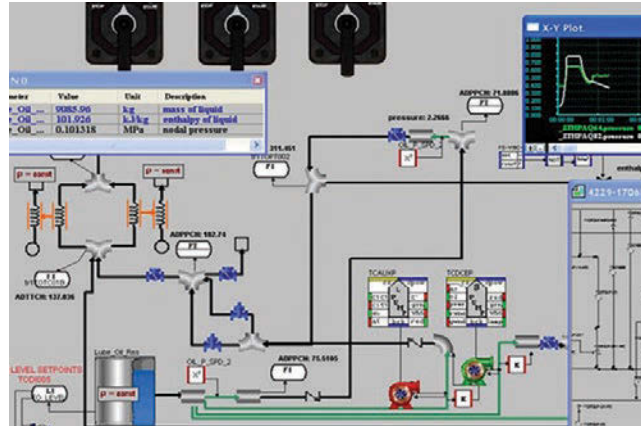
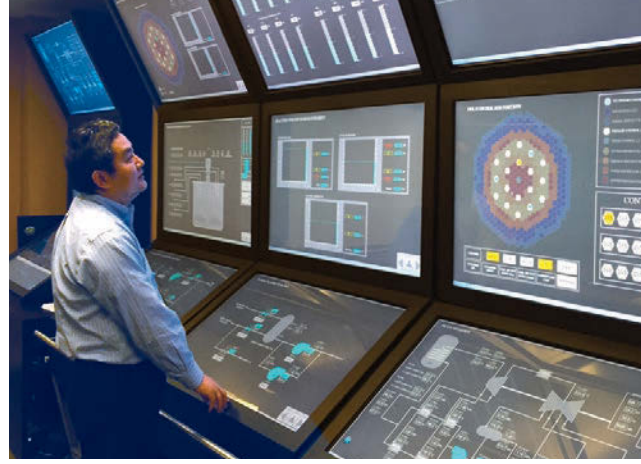

# Innovative Simulation Solutions

*High-Fidelity Simulators   Simulation Assisted Engineering   Web-Enabled Training*

## **CURTISS-WRIGHT ACQUIRES WSC, INC.**

*Curtiss-Wright Corporation is pleased to welcome WSC, Inc. into our Nuclear Division. WSC's innovative simulation solutions, including Simulation Assisted Engineering (SAE) and full-scope training simulators, will expand our portfolio of digitalization products, improve our capabilities for modernizing and extending the life of nuclear plants, and elevate our support for the Advanced Small Modular Reactor market.*

**CURTISS -  
WRIGHT**

[www.cwnuclear.com/WSC](http://www.cwnuclear.com/WSC)

- ◆Framatome Inc., (North American Headquarters), Lynchburg, VA (CT, CP, CD, DM, DD, EC, E, EP, ER, EA, FS, FP, IS, PD, PP, QA, RI, SE, SI, TR, VP, WM, WC)
- Gamma Reality Inc., Richmond, CA (TE)
- GE Hitachi Nuclear Energy, Wilmington, NC (CT, EM, ES, FT, R, RE, RI, SE)
- General Atomics Electromagnetic Systems, San Diego, CA (EM, RC)
- Global Quality Management Advisors, Lynchburg, VA (CR, DD, ET, EA, EG, PS, PM, QA, RO)
- GLSEQ, LLC, Huntsville, AL (CB, CW, ER, EA, VP)
- GNS Gesellschaft fur Nuklear-Service mbH, Essen, Germany (WM)
- GoldSim Technology Group, Seattle, WA (R, RI, SI)
- Gravis Technologies, Inc., Wallace, ID (CD, DB, EM)
- GSE Engineering, Systems & Simulation, (GSE Systems), Columbia, MD (SI)
- GSE Workforce Solutions, Training Services, (Formerly known as Hyperspring), Columbia, MD (CF, CM, CR, CP, DB, EP, ER, EA, EG, EM, ES, FP, IS, MC, P, PD, WC)
- H3D, Inc., Ann Arbor, MI (RC)
- HGP Inc., Greenville, SC (DB, VP, V)
- Hoskin Scientific, Oakville, Ontario, Canada (EM)
- Huxtable Consulting LLC, Hilton Head, SC (CD, EC, EA, FA, FP, SP)
- ◆I.C.E. Service Group, Inc., Moon Township, PA (WM)
- InfoTech NorthStar, Richland, WA (ET, EG, WM)
- InVizion LLC, Oak Ridge, TN (EC, EG, PM)
- ISO-PACIFIC Remediation Technologies, Inc., Richland, WA (DM, EM, RC, SN)
- James Fisher Technologies, Loveland, CO (D, TE)
- Jensen Hughes, Baltimore, MD (AI, CB, CT, CR, DB, DD, E, EP, ER, EA, EG, EM, FR, FS, P, PD, PP, QA, R, RI, RO, SP, TR, V)
- KCI Engineering Consultants, Downers Grove, IL (CD, E)
- Kinectrics Inc., Toronto, Ontario, Canada (D)
- Knowledge Relay, Cypress, CA (CM, CP, DB, MC, OS, PM, RI)
- L3Harris MAPPS Inc., (Power Systems and Simulation), Montreal, Quebec, Canada (ET, EA, PD, QA, SI)
- Longenecker & Associates, Inc., Las Vegas, NV (RI)
- Maxeta Technologies, Inc., Skillman, NJ (CD, ET, RC)
- Mirion Technologies (Canberra) Inc., Meriden, CT (CD, DB, D, EM, FA, QA, RC, SP, S, TR, WM)
- Mirion Technologies, Inc., (Sensing Systems Div.), Atlanta, GA (CF, DB, ET, EM, IN, RC, SI, SP, S)
- Mitsubishi Nuclear Energy Systems, Inc., (A Sub. of Mitsubishi Heavy Industries, Ltd.), Charlotte, NC (AI, CB, CW, CF, CM, CA, CT, CR, CP, CD, DB, DM, D, DD, EC, ET, E, EP, ER, EA, EM, EQ, ES, FT, FR, FS, FA, FP, FX, IS, IN, IC, MC, M, OS, P, PD, PP, PS, PM, QA, RC, R, RE, RI, RO, SE, SI, SM, SP, SN, S, TS, TE, TR, VP, V, WM, WC)
- Murray and Trettel, Inc., Palatine, IL (EM)
- ◆NAC International Inc., Peachtree Corners, GA (SP, SN, V)
- Navarro, Oak Ridge, TN (CA, DB, ER, EM, PM, QA, RC)
- Neptune and Company, Inc., Lakewood, CO (AI, CD, DB, EC, EM, ES, PM, QA, RI, SI, SP, TR, WM)
- Newton Research Labs, Inc., Renton, WA (FP, V)
- NextAxiom Technology, Inc., San Francisco, CA (CR, CD, EQ, FR, PP, PS, SP)
- Nuclear-21, Waasmunster, Belgium (CT, ET, ES, V)
- NuclearConsultants.com, Ann Arbor, MI (FP)
- NuclearN, Phoenix, AZ (AI, CM, CR, CP, CD, DB, EC, EP, EG, FR, IC, MC, M, OS, PP, PS, PM, QA, R, RE, RI, RO, TS, TR, V)
- Nucleonova S.L., Valencia, Spain (EA, EG, QA)
- Numerical Advisory Solutions, LLC, Cary, NC (CD, DB, DD, E, EA, FS, HX, P, PD, PP, PM, RE, SE, SP, V)

- NuVision-HWM, (Wälischmiller Engineering), Pittsburgh, PA (TE)
- ORTEC, Oak Ridge, TN (EM, SP, S)
- Pajarito Scientific Corp., Santa Fe, NM (ES, IN, V, WM)
- PAR Systems, LLC, Saint Paul, MN (FT, R, TE)
- ◆Paragon Energy Solutions, (Paragon), Fort Worth, TX (AI, DB, V)
- Paxton & Vierling Steel, Carter Lake, IA (QA)
- Power & Energy Systems Services, Oradell, NJ (EA, PD, PP, TS)
- Premier Technology, Inc., Blackfoot, ID (HX, WM)
- Primm Consulting, LLC, Knoxville, TN (EC, FP, SI, SP, V)
- ◆Radiation Safety & Control Services, Inc., Seabrook, NH (CD, DB, EM, IN, IC, RC)
- Radium Inc., Waynesboro, VA (CM, CR, CP, CD, EQ, IS, IC, MC, M, OS, PD, PP, PS, PM, V)
- Red Wolf Associates, Cary, NC (CT, CD, EA, FS, HX, P, PD, PP, PM, QA, RI, SI, SP, V)
- RKVST, Santa Clara, CA (DB, DM, PS, SN, WM)
- SimGenics Simulation Systems LLC, Southlake, TX (SI)
- Siteflow, London, United Kingdom (DB, IC, MC, PS, PM, QA, SN, V, WM)
- Howard L. Sobel, P.E., Oceanside, NY (CA, DB, FA, PM, QA, SN)
- Southwest Research Institute, San Antonio, TX (AI, CD, DB, ET, EA, EM, ES, FS, P, QA, RC, R, RI, RO, SI, S, TE, TR, WM)
- Studs vik Scandpower Inc., Wilmington, NC (CT, ET, EA, FP, PP, SI)
- Success Staging International, LLC, Evans, GA (CF, CR, CP, DB, EA, PD, PP, PM, QA, RI, RO, V)
- Technical Associates, (a Div. of US Nuclear Corp.), Canoga Park, CA (RC)
- Teledyne Brown Engineering, Inc., Huntsville, AL (EM)
- Theseus Quality Assurance, LLC, Richland, WA (ET, QA)
- Toshiba America Energy Systems Corp., West Allis, WI (AI, CF, CM, CR, CP, CD, DB, ET, EQ, ES, MC, M, PD, PM, QA, R, RE, RI, SI, SM, SP, TS, TR, VP, V, WC)
- TRAD - RayXpert, Labège cedex, France (CM, DM, D, ET, ES, IN, P, PD, PP, RC, WM)
- TradeWind Services LLC, Richland, WA (CF, CM, CA, CR, CP, CD, DB, DM, D, DD, ET, E, EP, EA, EG, EM, ES, FR, FS, IN, IC, MC, OS, P, PD, PP, PS, PM, QA, RC, R, RI, RO, SE, SI, SM, SP, SN, S, V, WM)
- TransWare Enterprises Inc., St. Louis, MO (CF, CD, EA, PD, PM, QA, SI, SM, SP, V)
- ◆Ultra Energy, (Weed Instrument), Round Rock, TX (EP, ER)
- University of Bristol, (Interface Analysis Centre) (South West Nuclear Hub), Bristol, United Kingdom (R, S)
- UxX, LLC, Roswell, GA (EC)
- VAT Group, San Jose, CA (ET, IS, IC, VP)
- Volian Enterprises, Inc., Murrysville, PA (CD, DB, ER, MC, SP, TS)
- Wälischmiller Engineering GmbH, Markdorf, Baden-Württemberg, Germany (TE)
- Westinghouse Electric Co. LLC, Cranberry Township, PA (CF, CT, CD, D, EA, FP, IS, PP, PS, RC, SI, SP, SN, TS, V, WM)
- ◆WGM, Inc., Peekskill, NY (DB, EM, IC, RC, SM, SP, SN, WM)

**See advertisement on page 5**

- Zachry Nuclear Engineering, Charlotte, NC (CF, CD, DB, FS, PD, QA, RC, SI, SM, SN, WC)

### 12900 Computers & Accessories

- A Analog
- AI Artificial Intelligence Systems
- CG Color Graphics
- C Converters
- DD Digital
- DD Disk Drives
- ES Expert Systems
- HH Hand-Held
- H Hybrid
- IO Input/Output Interface Units
- MF Main Frame
- MS Mass Storage Units
- M Memory Units
- MC Micro

- MP Microprocessor Circuit Boards
- MN Mini
- PR Printers
- TD Tape Drives
- VD Video Display Units
- Advetage Solutions, El Segundo, CA (VD)
- ◆Ahlberg Cameras, Wilmington, NC (VD)
- Arkitek Scientific, Paso Robles, CA (CG)
- Aurum Technologies, Blackfoot, ID (AI, D, ES, H)
- ◆AVANTech, LLC, Columbia, SC (A, CG, D, IO)
- ◆Bot Engineering Ltd, Campbellville, Ontario, Canada (A, C, D, H, MP)
- ◆Curtiss-Wright Nuclear Division, Brea, CA (D, MC, MN)
- Curtiss-Wright Nuclear Division, Sciencetech, Idaho Falls, ID (D, MC, MN)
- ◆Element Nuclear (NTS Labs), (Nuclear Engineering & Test Services), Huntsville, AL (D, IO, VD)
- ◆Framatome Inc., (North American Headquarters), Lynchburg, VA (CG, IO, MP, VD)
- GE Hitachi Nuclear Energy, Wilmington, NC (AI, CG, D)
- GLSEQ, LLC, Huntsville, AL (HH)
- Millspace Electronics, Mason, OH (A, D, IO, MP)
- Mirion Technologies (Canberra) Inc., Meriden, CT (D, MC, MN)
- ◆Paragon Energy Solutions, (Paragon), Fort Worth, TX (A)
- Southwest Research Institute, San Antonio, TX (AI)
- Thinklogical, A Belden Brand, Milford, CT (VD)
- Toshiba America Energy Systems Corp., West Allis, WI (A, AI, CG, C, D, DD, ES, HH, IO, MF, MS, MC, MP, MN, PR, TD, VD)

### 13050 Concrete Breaking, Drilling, Sawing & Scabbling

- C Contractors
- E Equipment
- R Equipment Rental
- ◆American DND Inc., Grand Island, NY (C, E, R)
- Baker Concrete Construction, Inc., Houston, TX (C)
- BHI Energy - now Westinghouse, See listing for Westinghouse Electric Co., Cranberry Township, PA (C, E, R)
- Bluegrass Concrete Cutting, Inc., Greenville, AL (C)
- Brokk AB, Skelleftea, Sweden (E)
- ◆Brokk Inc., (Sub. of Brokk-Sweden), (Nuclear Div.), Santa Fe, NM (E, R)
- Cutting Technologies (CTI), Gloucester City, NJ (C, E, R)
- Desco Mfg. Co., Inc., Rancho Santa Margarita, CA (E)
- Dufrane Nuclear Shielding Inc., (Dufrane Nuclear Inc.), Winsted, CT (C)
- Fuel Tank Maintenance Co., LLC, Cookeville, TN (C)
- GEM Technologies, Inc., Knoxville, TN (C)
- In-Place Machining Company, LLC, Blue Ash, OH (C, E)
- James Fisher Technologies, Loveland, CO (C, E)
- Mega-Tech Services, LLC, Cooksburg, PA (C)
- New Millennium Nuclear Technologies International, Lakewood, CO (C)
- Westinghouse Electric Co. LLC, Cranberry Township, PA (C, E, R)

### 13180 Condensers, Air-Cooled

- ◆Curtiss-Wright Nuclear Division, Brea, CA
- Curtiss-Wright Nuclear Division, QualTech NP, Cincinnati, OH
- DC Fabricators Inc., Florence, NJ
- Ellis & Watts Global Industries, Inc., (a sub. of Marmor\*, a Berkshire Hathaway company), Batavia, OH
- Energyen Corporation, (Sales Operation), Gunsan, Korea (The Republic of)
- ◆Holtec International, Camden, NJ
- NuSource LLC, Alexandria, VA
- PMT Nuclear, Woodridge, IL
- ◆Westinghouse Electric Company LLC, (Westinghouse Parts Business), New Stanton, PA

# Over 13,000 machines deployed

TUNNELING

CONSTRUCTION

MINING

**NUCLEAR**

PROCESS

CEMENT



Access Catalog  
and find your Robot

## Extraordinary power and reliability for extraordinary jobs.

**Some projects require a special solution.** Brokk offers a unique and well proven combination of equipment, design, engineering and technical support for the most challenging projects at nuclear facilities.

Brokk is the industry leader for safe, rugged, reliable, heavy-duty, remotely operated equipment and with 10 available base machine options, there is a Brokk machine size available to suit each application without compromise.

Brokk machines are available with many standard options including vision systems, radiation hardening, auto tool change, auto recovery capabilities and more. They can also be customized and fitted with additional special options as needed for specific customer projects.

Brokk also offers hundreds of standard and custom designed tools and attachments for our machines. With our standard quick change attachment interface or our optional fully remote tool change interface, a single Brokk machine can perform multiple tasks in hazardous environments with the operator always working in complete safety.

Now add to that over 40 years of Brokk deployment experience, our in-house engineering and technical support staff, on-site training and after sales support and you can see that Brokk provides comprehensive support to our customers who are working on very challenging projects.

For more information Contact Tony Marlow Tel: (505) 699 8923, email: [tony@brokkinc.com](mailto:tony@brokkinc.com)

Original Demolition Power™

# **BROKK**®

**13200 Condensers, Power Plant**

- BHI CO., LTD., Haman-gun, Korea (The Republic of)  
 BWX Technologies, Inc., Lynchburg, VA  
 ♦ Curtiss-Wright Nuclear Division, Brea, CA  
 Curtiss-Wright Nuclear Division, QualTech NP, Cincinnati, OH  
 DC Fabricators Inc., Florence, NJ  
 Energyen Corporation, (Sales Operation), Gunsan, Korea (The Republic of)  
 ♦ Framatome Inc., (North American Headquarters), Lynchburg, VA  
 Heatric Division of Meggitt (UK) Ltd., Poole, Dorset, United Kingdom  
 Hennigan Engineering LLC, Hingham, MA  
 ♦ Holtec International, Camden, NJ  
 Joseph Oat Corp., Camden, NJ  
 Mitsubishi Nuclear Energy Systems, Inc., (A Sub. of Mitsubishi Heavy Industries, Ltd.), Charlotte, NC  
 NuSource LLC, Alexandria, VA  
 Plastocor, Inc., Hingham, MA  
 ♦ Thermal Engineering International (TEI), Cerritos, CA  
 ♦ Westinghouse Electric Company LLC, (Westinghouse Parts Business), New Stanton, PA

**13220 Condensing Pots, Steam**

- DC Fabricators Inc., Florence, NJ  
 Joseph Oat Corp., Camden, NJ  
 NuSource LLC, Alexandria, VA  
 Toshiba America Energy Systems Corp., West Allis, WI  
 ♦ Westinghouse Electric Company LLC, (Westinghouse Parts Business), New Stanton, PA

**13400 Connectors**

- DC Data Communications  
 E Electrical  
 EG Electrical, Glovebox  
 EQ Electrical, Quick Disconnect  
 FO Fiber Optic  
 T Thermocouple  
 CableLAN Nuclear, Fort Myers, FL (DC, E, FO)  
 Centronic Ltd., Surrey, United Kingdom (T)  
 Consolidated Power Supply, (Div. of Consolidated Pipe & Supply Co., Inc.), Birmingham, AL (T)  
 ♦ Curtiss-Wright Nuclear Division, Brea, CA (E, EQ, FO, T)  
 Curtiss-Wright Nuclear Division, QualTech NP, Cincinnati, OH (E, EQ, FO, T)  
 ♦ Framatome Inc., (North American Headquarters), Lynchburg, VA (T)  
 Glenair, Inc., Wallingford, CT (E, EQ, FO, T)  
 Inert Corp., Amesbury, MA (EG)  
 James Fisher Technologies, Loveland, CO (E)  
 Kanata Electronic Services Ltd., (Div. of Shawcor Ltd.), Toronto, Ontario, Canada (EQ)  
 Kinectrics Inc., Toronto, Ontario, Canada (FO)  
 LEMO S.A., Ecublens, Switzerland (DC, E, EQ, FO, T)  
 ♦ Mirion Technologies (IST) Corp., (Sensing Systems Div.), Horseheads, NY (E, FO, T)  
 Mirion Technologies, Inc., (Sensing Systems Div.), Atlanta, GA (E, FO, T)  
 ♦ Paragon Energy Solutions, (Paragon), Fort Worth, TX (E, EG, EQ, T)  
 ♦ Photonis, Brive la Gaillarde Cedex, France (E)  
 Scientific Sales, Inc., Oak Ridge, TN (DC, E, EG, EQ, FO, T)  
 Teledyne Brown Engineering, Inc., Huntsville, AL (E, EG)  
 Temp-Pro Inc., Northampton, MA (T)  
 THERMOCOAX Inc., Alpharetta, GA (E, T)  
 Toshiba America Energy Systems Corp., West Allis, WI (DC)  
 Westinghouse Electric Co. LLC, Cranberry Township, PA (E, EQ, FO, T)  
 ♦ Westinghouse Electric Company LLC, (Westinghouse Parts Business), New Stanton, PA (DC, E, EG, EQ, FO, T)

**13600 Consoles, Control**

- ♦ AVANTech, LLC, Columbia, SC  
 Energy Steel, Rochester Hills, MI

- GE Hitachi Nuclear Energy, Wilmington, NC  
 ♦ Paragon Energy Solutions, (Paragon), Fort Worth, TX  
 Thinklogical, A Belden Brand, Milford, CT  
 Toshiba America Energy Systems Corp., West Allis, WI  
 Westinghouse Electric Co. LLC, Cranberry Township, PA  
 ♦ Westinghouse Electric Company LLC, (Westinghouse Parts Business), New Stanton, PA

**13700 Construction Materials**

- AE Anchors, Chemical (Epoxy)  
 A Anchors, Concrete  
 AF Asbestos-Free Fiber Cement  
 CG Commercial Grade Dedication  
 C Concrete  
 RB Concrete Reinforcement, Bar (Rebar)  
 RM Concrete Reinforcement, Mesh  
 LF Lumber, Fire-Retardant-Treated  
 R Refractory  
 SP Splices, Rebar  
 SS Steel, Structural  
 AECON-WACHS, (U.S. Div. of Aecon Nuclear), Jackson, SC (SS)  
 Carolina Fabricators, West Columbia, SC (SP, SS)  
 Consolidated Power Supply, (Div. of Consolidated Pipe & Supply Co., Inc.), Birmingham, AL (A, RB, RM, SP, SS)  
 Container Technologies Industries, LLC, Helenwood, TN (SS)  
 ♦ Curtiss-Wright Nuclear Division, Brea, CA (A)  
 Curtiss-Wright Nuclear Division, Nova, Middleburg Heights, OH (A)  
 Cutting Technologies (CTI), Gloucester City, NJ (AE, A)  
 ♦ DuBose National Energy Services, Inc., Clinton, NC (AE, A, RB, RM, SP, SS)  
 Dufrane Nuclear Shielding Inc., (Dufrane Nuclear Inc.), Winsted, CT (C, RB)  
 Joseph Oat Corp., Camden, NJ (A, RB, SP, SS)  
 Lincoln Structural Solutions, Louisville, NE (AE, A, RB, SP, SS)  
 MillenniTEK, LLC, Knoxville, TN (R)  
 Nuclear Shielding Supplies & Service, Tucson, AZ (C)  
 Paxton & Vierling Steel, Carter Lake, IA (SS)  
 PMT Nuclear, Woodridge, IL (CG, SS)  
 Premier Technology, Inc., Blackfoot, ID (SS)  
 ♦ SSM Industries, Inc., (Nuclear Div.), Pittsburgh, PA (CG)  
 Tioga Pipe, Philadelphia, PA (SS)  
 Trust Manufacturing, LLC, Euclid, OH (A, SS)  
 TW Metals - Nuclear Materials Solutions, Linden, MI (A, RB, RM, SP, SS)  
 UCC Industries International Inc., Pickering, Ontario, Canada (SS)

**13850 Construction/Engineering Services**

- AE Architect-Engineers  
 CE Civil Engineers  
 CS Construction Services  
 EC Engineer-Constructors  
 ES Erection Services  
 Advanced Consulting Group, Inc., Chicago, IL (AE)  
 Advanced Nuclear LLC, Aston, PA (ES)  
 Advanced Technologies and Laboratories (ATL) International, Inc., (wholly owned sub. of Planned Systems International, Inc.), Gaithersburg, MD (AE)  
 AECON-WACHS, (U.S. Div. of Aecon Nuclear), Jackson, SC (CS, EC, ES)  
 American DND Engineering, PC, Ellicottville, NY (AE, CS, EC)  
 ♦ American DND Inc., Grand Island, NY (CS)  
 Babcock Services, Inc., Kennewick, WA (AE, CE, CS, EC)  
 Baker Concrete Construction, Inc., Houston, TX (CS)  
 Barge Design Solutions, Nashville, TN (AE, CE)  
 ♦ Barnhart Nuclear Services, Fairhope, AL (CS, ES)  
 ♦ Bechtel, (Bechtel Power), (Bechtel Nuclear, Security & Environmental), (Bechtel National), Reston, VA (AE, CS, EC)

- BHI Energy - now Westinghouse, See listing for Westinghouse Electric Co., Cranberry Township, PA (CE, CS, EC)  
 Black & Veatch, Overland Park, KS (AE, CE, CS, EC, ES)  
 Bluegrass Concrete Cutting, Inc., Greenville, AL (CS)  
 ♦ Boston Government Services, LLC (BGS), Oak Ridge, TN (AE, CE, CS, EC)  
 Bureau Veritas Inspection and Insurance Co., (previously OneCIS Inspection and Insurance Co.), Lynn, MA (CS)  
 Burns & McDonnell, Kansas City, MO (AE, CE, CS, EC, ES)  
 Dufrane Nuclear Shielding Inc., (Dufrane Nuclear Inc.), Winsted, CT (CS, EC, ES)  
 E.S. Fox Limited, Niagara Falls, Ontario, Canada (CS, EC, ES)  
 EKIUM, Bron Cedex, France (AE, CE, CS)  
 Electrical Builders Inc. (EBI), St. Cloud, MN (CS, EC)  
 Energy Steel, Rochester Hills, MI (AE, CE, EC)  
 Engineered Rigging, Russellville, AR (AE, CE, CS, EC)  
 Fuel Tank Maintenance Co., LLC, Cookeville, TN (CS)  
 GE Hitachi Nuclear Energy, Wilmington, NC (EC)  
 GEM Technologies, Inc., Knoxville, TN (AE, CE, CS, EC, ES)  
 GSE Engineering, Design & Analysis, (Formerly known as DP Engineering), Fort Worth, TX (AE, CE, CS, EC, ES)  
 GSE Engineering, Systems & Simulation, (GSE Systems), Columbia, MD (AE, CE, CS, EC, ES)  
 Idom Consulting, Engineering, Architecture S.A.U., Bilbao, Spain (AE, CE, CS, EC)  
 Imperia Engineering Partners LLC, Milford, MA (CE, CS, EC)  
 In-Place Machining Company, LLC, Blue Ash, OH (CS, EC)  
 KCI Engineering Consultants, Downers Grove, IL (AE, CE, EC)  
 ♦ Kiewit Nuclear Solutions Co., Oak Ridge, TN (CE, CS, EC, ES)

**See advertisement on page 59**

- Kinectrics Inc., Toronto, Ontario, Canada (CE)  
 LATA, Albuquerque, NM (CE)  
 Leak Testing Specialists, Inc., Orlando, FL (EC)  
 Longenecker & Associates, Inc., Las Vegas, NV (CS)  
 Manafort Brothers Inc., Plainville, CT (CS)  
 Merrick & Company, Greenwood Village, CO (CE)  
 Mitsubishi Nuclear Energy Systems, Inc., (A Sub. of Mitsubishi Heavy Industries, Ltd.), Charlotte, NC (AE, CE, CS, EC, ES)  
 ♦ NAC International Inc., Peachtree Corners, GA (EC)  
 NAES Power Contractors, Inc., Shelocta, PA (CS)  
 Navarro, Oak Ridge, TN (CE, CS)  
 North Wind Group, Idaho Falls, ID (AE, CE, CS, EC)  
 Nuclear Energy Components Ltd, Hope Valley, Derbyshire, United Kingdom (ES)  
 Numerical Advisory Solutions, LLC, Cary, NC (AE, CS, EC)  
 Orano Federal Services, Charlotte, NC (AE)  
 Perma-Fix Environmental Services, Inc., Oak Ridge, TN (CE, CS, EC)  
 PMT Nuclear, Woodridge, IL (CS, ES)  
 Sarens Nuclear & Industrial Services LLC, (Sarens), Houston, TX (CS, EC, ES)  
 SKODA JS a.s., Plzen, Bolevec, Czech Republic (The) (EC, ES)  
 Success Staging International, LLC, Evans, GA (AE, CE)  
 Tetra Tech Inc., Richland, WA (AE, CE, CS, EC, ES)  
 Toshiba America Energy Systems Corp., West Allis, WI (CS, EC, ES)  
 TradeWind Services LLC, Richland, WA (AE, CE, CS, EC, ES)  
 United Engineers & Constructors, Inc., (Sub. of Imperia Engineering Partners), Mount Laurel, NJ (AE, CE, CS, EC)  
 Veolia Nuclear Solutions - Federal Services, Piketon, OH (CE, EC)  
 Westinghouse Electric Co. LLC, Cranberry Township, PA (AE, CE, CS, EC)



♦ Denotes advertiser—see Index to Advertisers on pages 8–14

**14000 Consultants**

- AC Air Cleaning, Filtration
- AU Auditing
- BD Business Development
- C Chemical Process Design
- CO Coatings/Corrosion
- CM Communications, Management-Employee
- CD Component/System Design & Analysis
- CS Computer Systems & Software
- CC Configuration Control
- CA Contract Administration
- CH Cranes & Hoists
- CE Criticality Hazard Evaluation
- DC Decontamination
- DE Decommissioning
- DN Design, Nuclear Facilities
- ES Earth Science Services
- EA Economic Analysis, Trade-off Studies
- EP Emergency Planning & Response
- E Environmental
- EC Equipment Condition Monitoring
- FP Fire Protection
- FL Foreign Language Interpretation & Translation
- F Fuel Cycle & Fuel Performance
- FT Fuel Transport/Storage
- HT Heat Transfer & Fluid Flow
- HF Human Factors Engineering
- HY Hydraulics
- HD Hydrodynamics
- IP Independent Project Reviews
- IE Instrumentation & Electrical
- IM Inventory Management
- IS ISO Compliance
- LR License Renewal
- L Licensing
- LP Lightning Protection
- MN Maintenance
- MA Management Audit
- MI Management Information & Control Systems
- M Meteorology

- N Noise Abatement
- OA Obsolescence Assessment
- O Operations Analysis & Procedures Preparation
- OD Organization Development
- OM Outage Management
- PE Performance Measurement
- PH Personnel Stress/Health
- P Piping
- PL Plant Life Extension
- PA Plant Performance
- PM Preventive Maintenance
- PS Procurement Support
- PD Professional Development
- PP Project Planning & Management
- PT Proposal Management
- PR Prudence Studies
- QU Qualification, Commercial Grade (Dedication)
- QA Quality Assurance/Quality Control
- RD Radiation Management
- RE Radiological Engineering
- RM Records Management Systems
- RO Reengineering, Organization
- RC Regulatory Compliance
- R Reliability
- RS Research Services, Nuclear
- RA Risk Analysis
- SN Safety, Nuclear
- SA Safety, Plant
- SR Safety, Reactor
- S Security
- SE Seismic
- SH Shielding
- SS Simulation Services
- SI Siting
- SP Spare Parts Systems
- SY System Engineering-Requirements Analysis
- ST Systems Testing
- TE Training Evaluation, Management
- TA Trend Analysis & Corrective Action Programs
- V Vibration

- WM Waste Management
- WT Water Treatment
- 3G Services Company LLC, Clinton, MS (TE)
- Adam Brown Consulting, Inc., Cary, IL (AU, BD, CO, DE, FP, IP, MN, MA, O, OD, OM, PE, PP, QU, QA, SA)
- Advanced Consulting Group, Inc., Chicago, IL (DE, MN, P, PL, PP)
- Advanced Cooling Technologies, Inc., Lancaster, PA (HT)
- Advanced Technologies and Laboratories (ATL) International, Inc., (wholly owned sub. of Planned Systems International, Inc.), Gaithersburg, MD (DC, DE, E, IP, RD, RC, RA, SN, SR, SH, WM)
- Advetage Solutions, El Segundo, CA (DE, RD, RE, WM)
- AECON-WACHS, (U.S. Div. of Aecon Nuclear), Jackson, SC (DC, DE, DN, MN, P)
- Aegis, LLC, Ooltewah, TN (AC)
- ♦Alphasource, Inc., Philadelphia, PA (SA)
- ♦American DND Inc., Grand Island, NY (CA, CH, DC, DE, E, PP, SA, WM)
- F.N. Anderson & Assoc., Forest, VA (CD, CE, DE, E, F, FT, HT, QA, SN, SR, SH, WM)
- Applied Analysis Corp., Reading, PA (CD, DN, FT, HT, HD, IP, L, M, QA, RE, RC, SN, SR, SH, SS, SI)
- Aptim, Baton Rouge, LA (DE, P, PA, PM, PP, QA, SA, SR)
- ARES Security Corp., Vienna, VA (EP, S)
- Argonne National Laboratory, (EOF Div.), Lemont, IL (DE)
- ASI Marine, (ASI Group Ltd.), Orchard Park, NY (HD, P, WT)
- ASVAD INTL SL, Tarragona, Spain (SR)
- ATS Industrial Automation, Inc. - Nuclear (UK), Blaby, Leicester, United Kingdom (DE, WM)
- ATS Industrial Automation, Inc. Nuclear (Canada), Cambridge, Ontario, Canada (DE, WM)
- Attention IT, Inc., (Attention IT Ltd. (UK)), Knoxville, TN (CS, MI, WM)

# DELIVERING THE FUTURE OF NUCLEAR ENERGY



Together with our utility partners, Bechtel has delivered over 76,000 MW of carbon-free nuclear energy to the grid

**NATRIUM DEMONSTRATION**

Bechtel is the Engineering, Procurement, and Construction (EPC) partner for TerraPower, the advanced nuclear technology firm leading the development and deployment of the Natrium™ technology as part of a unique public-private Advanced Reactor Development Program (ARDP) with U.S. Department of Energy to design and build a demonstration plant for the Natrium™ sodium fast reactor.

**The Next Generation**



**WATTS BAR UNIT 2**

Bechtel was the prime contractor to the Tennessee Valley Authority (TVA) and provided EPC services in the successful completion and return to service of the deferred Watts Bar Unit 2.



**DRESDEN**

In 1957, Bechtel continued its commitment to the fledgling nuclear power industry—which started with our support of the Experimental Breeder Reactor 1 in 1949—by working with partners to develop the Dresden Nuclear Station, the world's first privately financed nuclear power plant.



**2023**

**PLANT VOGTLE, UNITS 3 & 4**

Bechtel was selected to complete the construction and support commissioning of Vogtle Units 3 & 4 the first advanced Gen III+ units built in the U.S. With Watts Bar 2 and Vogtle 3 & 4 commercial operations, **Bechtel is the only U.S. EPC firm to deliver new nuclear power to the grid in the 21st century.**

**2016**

**PALO VERDE, UNITS 1, 2 & 3**

Bechtel was the architect/engineer and constructor of Palo Verde in the Arizona desert, the largest nuclear plant in the U.S. at the time (recently eclipsed by Vogtle).

**1986**

**1960**

bechtel.com

- ◆AVANTech, LLC, Columbia, SC (C, E, SH, WM, WT)
- Babcock Services, Inc., Kennewick, WA (AU, CM, CA, DC, DE, PS, PP, QA, RD, RE, WM)
- Bakelite Synthetics, Atlanta, GA (CO)
- ◆Banda Group International, LLC, Mesa, AZ (CA, EP, E, FP, MA, PP, SN, S, WM)
- ◆Barnhart Nuclear Services, Fairhope, AL (CH)
- ◆G.D. Barri & Associates, Inc., Peoria, AZ (MN, PP, WM, WT)
- Basic E, Inc., Charlotte, VT (IM, PS)
- Battery Lane LLC, Carson City, NV (BD, CA, EA, MI, O, OD, PE, PD, RS)
- ◆Bechtel, (Bechtel Power), (Bechtel Nuclear, Security & Environmental), (Bechtel National), Reston, VA (LR, L)
- Berthold Technologies USA LLC, Oak Ridge, TN (RD)
- Bevelacqua Resources, (Radiation Protection), Owens Cross Roads, AL (CE, DC, DE, E, OM, RD, RE, RS, RA, SN, SA, SR, TE, WM)
- BHI Energy - now Westinghouse, See listing for Westinghouse Electric Co., Cranberry Township, PA (AC, CO, CD, CS, CC, DC, DE, DN, EP, E, IP, IE, LR, L, MN, MA, MI, O, OM, PE, PL, PA, PS, PP, QA, RD, RE, RC, RA, SN, SA, S, SH, SY, ST, TE, TA)
- Black & Veatch, Overland Park, KS (AC, C, CM, CD, CS, CC, CA, DE, DN, ES, EA, E, EC, FP, FT, HT, HF, HY, HD, IP, IE, LR, L, LP, MA, MI, N, O, OD, P, PL, PA, PM, PS, PP, PT, PR, QU, QA, RE, RM, RO, RC, R, RA, SN, SA, SR, S, SE, SI, SP, ST, TE, TA, WT)
- ◆Boston Government Services, LLC (BGS), Oak Ridge, TN (CD, CS, CC, CE, DC, DE, DN, FP, IP, IE, MA, MI, O, P, PP, QU, QA, RD, RE, RM, RC, RS, RA, SN, SA, SR, S, SH, SS, SY, ST, TE, TA, WM)
- Brownstone Psychological Associates, Manitowoc, WI (SN, SA)
- Bureau Veritas Inspection and Insurance Co., (previously OneCIS Inspection and Insurance Co.), Lynn, MA (QU, QA, RC)

- Burns & McDonnell, Kansas City, MO (AC, C, CO, CM, CD, CS, CC, CA, CH, CE, DC, DE, DN, ES, EA, E, FP, HT, HY, HD, IP, IE, LR, L, O, OD, OM, PE, P, PL, PA, PM, PS, PP, PT, PR, QU, QA, R, SN, SA, SR, S, SE, SH, SI, SY, ST, TE, TA, WM, WT)
- BWX Technologies, Inc., Lynchburg, VA (CD, DE, DN, E, F, FT, HT, HF, IP, MN, OA, OM, PL, PA, PM, PT, QA, RS, SN, SR, S, SE, SH, SY, ST)
- Cabrera Services Inc., East Hartford, CT (CE, DC, DE, EP, E, PP, QA, RD, RE, RC, RA, WM)
- Campoverde srl, Milano, Italy (DC, DE, RE)
- Carignan & Associates LLC, Chattanooga, TN (DC, DE, O, PP, TE)
- CBS Nuclear Services, Inc., Matthews, NC (SN)
- Centronic Ltd., Surrey, United Kingdom (RD, RE, RS, SN, SA, SR)
- Chesapeake Nuclear Services, Inc., Annapolis, MD (DC, DE, EP, E, M, RD, RE, SH, WM)
- Cohesive, St. Louis, MO (CS, IP, IM, MN, MI, OD, PM, PP, PT, R)
- Computer Engineering Services, Inc., Chattanooga, TN (CS, RD, RC)
- Concurrent Technologies Corporation, (Center for Advanced Nuclear Manufacturing), Johnstown, PA (C, CO, CD, CS, CC, ES, E, HT, HF, IE, IS, MN, PE, PM, PP, QU, QA, RS, SS, SY, ST, TE, WT)
- Consolidated Power Supply, (Div. of Consolidated Pipe & Supply Co., Inc.), Birmingham, AL (CO, CD, P, PL, PA, PM, PS, PP, QU, RA, SY)
- Cortec Corp., Saint Paul, MN (CO)
- CPMQ Consulting, LLC, Huntsville, AL (BD, IP, PP, PT, SA, TE)
- Cragg Consulting, Grapevine, TX (RA)
- Croft Associates Ltd, Abingdon, Oxfordshire, United Kingdom (SH)
- CS-2 Inc., Grand Island, NY (CA, DC, DE, E, PS, PP, QA, SA, WM)
- CTR Technical Services, Inc., Manitou Springs, CO (CE, F, IP, IE, L, PA, SR, SH)

- ◆Curtiss-Wright Nuclear Division, Brea, CA (AC, C, CD, CS, CC, CA, CH, CE, EP, E, EC, F, FT, HT, HY, IE, IM, LR, L, MN, MA, MI, OA, O, OM, P, PL, PA, PM, PS, PP, PR, QU, QA, RD, RM, RC, R, RS, RA, SN, SA, SR, S, SE, SH, SS, SP, ST, TE, WM)
- Curtiss-Wright Nuclear Division, AP Services, Middleburg Heights, OH (PM)
- Curtiss-Wright Nuclear Division, Enertech, Brea, CA (AC, CD, CA, EC, MN, P, PS, QA, RC, RA, SE, TE)
- Curtiss-Wright Nuclear Division, NETCO, Danbury, CT (CS, F, WM)
- Curtiss-Wright Nuclear Division, Nova, Middleburg Heights, OH (IM)
- Curtiss-Wright Nuclear Division, QualTech NP, Cincinnati, OH (E, IE, MN, OA, PL, PA, PM, PS, QU, QA, RC, R, SN, SE, SH, SP)
- Curtiss-Wright Nuclear Division, Sciencetech, Idaho Falls, ID (C, CD, CS, CC, CH, CE, EP, EC, F, FT, HT, HY, IE, IM, LR, L, MN, MA, MI, O, OM, P, PL, PA, PM, PS, PP, PR, QA, RD, RM, RC, R, RS, RA, SN, SA, SR, S, SE, SH, SS, SP, ST, TE)
- Czufin Consulting, LLC, Wilmington, NC (PA, R)
- DB2 Consulting Inc., Baltimore, Ontario, Canada (AU, BD, CA, HF, OD, PT)
- DCS Systems, Inc., Simsbury, CT (CS, F, FT, HF, IP, IS, MA, QU, QA, TA)
- Desco Mfg. Co., Inc., Rancho Santa Margarita, CA (CO, DC, DE, MN, OM, SA)
- Deytec, Inc., Ashburn, VA (FP, IP, L, PP, RC, RS, RA)
- DLE Technical Services, LLC, (BlueDragon Critical Thinking and Complex Problem Solving Workshops), Palm City, FL (OD, QA, TE, TA)
- ◆Dominion Engineering, Inc., Reston, VA (AC, C, CO, DC, DE, HT, HY, IP, LR, PE, P, PL, PA, PR, QU, RD, RE, RC, RA, SN, SR, SE, WM, WT)
- Dufrane Nuclear Shielding Inc., (Dufrane Nuclear Inc.), Winsted, CT (AU, CD, IP, MN, PM, PP, RD, RE, SH, WM, WT)
- DW James Consulting, LLC, North Oaks, MN (CS, DC, DE, DN, EP, E, IM, L, PP, PR, QA, RD, RE, RC, SH, WM)
- Dynatom International GmbH, Bassersdorf, Switzerland (LR, L, PS, RC)
- E.H. Wachs, (A Div. of ITW), Lincolnshire, IL (DE, MN)
- E.S. Fox Limited, Niagara Falls, Ontario, Canada (MN, P, QA, SN)
- Ebersen, Inc., Minneapolis, MN (E, IM, IS, L, MA)
- ECC, Burlingame, CA (DE, E, PP, RD, RE, WM)
- EKIUM, Bron Cedex, France (AC, C, CD, CS, CC, CE, DE, DN, EP, EC, FP, HT, HF, HY, HD, IS, L, LP, MN, MI, O, P, PL, PA, PS, PP, RO, RS, RA, SN, SA, SR, S, SE, SS, SP, SY, ST)
- Electrical Builders Inc. (EBI), St. Cloud, MN (EP, IE, MN, PL, PM, PP)
- ◆Element Nuclear (NTS Labs), (Nuclear Engineering & Test Services), Huntsville, AL (QU)
- Ellis & Watts Global Industries, Inc., (a sub. of Marmont, a Berkshire Hathaway company), Batavia, OH (AC)
- EmmEn Marketing Consultants, Pune, Maharashtra, India (BD, FL)
- Energy Resources International Inc., Washington, DC (CS, EA, F, MA, PS, PR, WM)
- Energy, Technology and Environmental Business Association, (ETEBA), Oak Ridge, TN (WM)
- ◆EnergySolutions, Salt Lake City, UT (CH, DC, DE, EA, EP, E, L, MA, O, PP, PT, QA, RD, RE, RC, RA, SN, SA, SR, SH, TE, TA, WM, WT)
- Engineered Rigging, Russellville, AR (CH, DN, MN, OM, PM, PP, QA)
- ENVINET GmbH, Munich/Haar, Germany (E)
- Environmental Restoration Group, Inc., Albuquerque, NM (DE, E, LR, L, RA)
- ◆EXCEL Services Corporation, Rockville, MD (DC, DE, EP, E, FP, F, IP, IE, LR, L, MA, O, OD, PL, PA, PP, PR, QA, RO, RC, RA, SN, SA, SR, S, SI, TE, WM)

See advertisement on page 1

- FEVDI Nuclear Decontamination, Corbas, France (DC, DE)



### Expertise Across the Nuclear Industry

- Advanced Reactor Systems
- Nuclear Facilities
- Fusion Systems
- Advanced Fuel Cycle



### Nuclear Solutions for Today's Market

- Design, fabrication, and testing of nuclear equipment
- Nuclear safety and security for government and commercial facilities
- Nuclear facility operational readiness
- Facility design and systems integration
- Advanced technology implementation:
  - Engineering and licensing
  - Fuel supply chain management
  - Radioisotope production

BGS-LLC.com

**ENGINEERING  
TECHNOLOGY  
CYBERSECURITY**

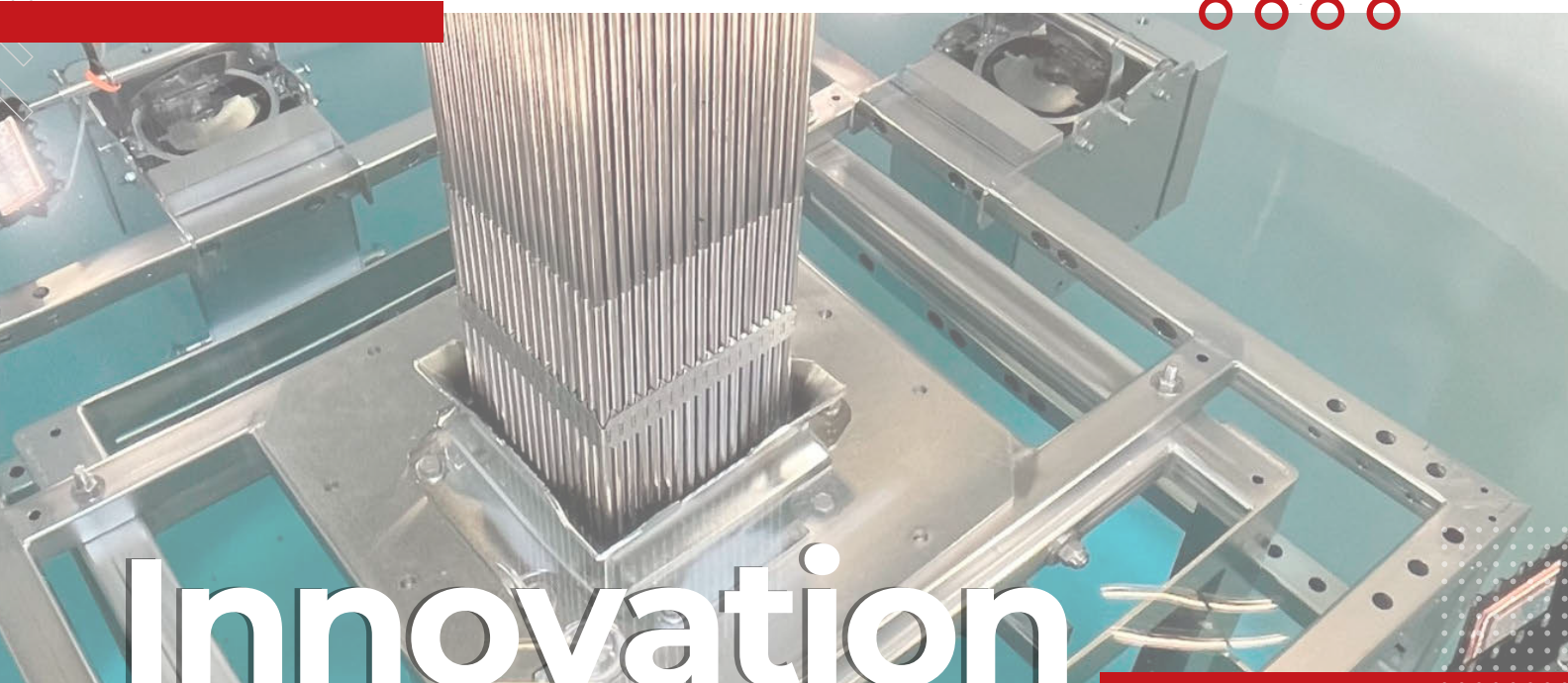

# Innovation

## for the next chapter in nuclear energy



### PRODUCTS AND TECHNOLOGY

Improving plant and outage performance



### CONSULTING SERVICES

Engineering capacities for unique technical challenges



### TESTING AND R&D

Customized analysis, modeling, and real-world validation

- ◆Framatome Inc., (North American Headquarters), Lynchburg, VA (C, CO, CD, CS, CC, CE, DC, DN, EP, E, FP, F, HT, HF, HY, HD, IE, IM, IS, LR, L, MN, O, OM, PE, P, PL, PA, PM, PS, PP, QU, QA, RD, RE, RM, RC, R, RS, RA, SN, SA, SR, S, SE, SH, SS, SP, SY, ST, TE, TA, WM, WT)
- Fuel Tank Maintenance Co., LLC, Cookeville, TN (CO, DC, DE, FP, FT, P, WT)
- Full On Communications, Woodstock, VT (CM)
- GE Hitachi Nuclear Energy, Wilmington, NC (C, CD, DC, DE, EP, E, F, HF, IE, LR, L, MN, MI, O, OM, P, PL, PM, PP, QU, QA, RD, RE, RM, R, SR, SE, SP, ST, WT)
- General Atomics Electromagnetic Systems, San Diego, CA (CD, CS, E, PP, RD, RE, RC, SS, SP, ST)
- General Magnaplex Corp., Arlington, TX (CO)
- Global Quality Management Advisors, Lynchburg, VA (AU, BD, CM, CC, CA, DN, E, IP, IS, MA, O, PP, QU, QA, RM, RC, R, RA, SN, SE, TE, TA, V)
- GLSEQ, LLC, Huntsville, AL (EC, LR, L, PL, PS, QU, SE)
- GoldSim Technology Group, Seattle, WA (E, RC, RA, WM)
- Gravis Technologies, Inc., Wallace, ID (BD, CM)
- Grecheck Consulting LLC, Midlothian, VA (CC, DN, EA, IP, LR, L, MA, OD, PL, PA, PR, RO, RC, SN)
- GSE Engineering, Design & Analysis, (Formerly known as DP Engineering), Fort Worth, TX (CC, DN, EC, FP, F, FT, HT, IE, MN, MA, MI, O, PE, PH, P, PM, PS, QA, RO, RC, R, RS, SN, SA, SR, SS, TA)
- GSE Engineering, Programs & Performance, (Formerly known as True North Consulting), Columbia, MD (CD, CS, CC, EA, E, EC, F, FT, HT, IP, IE, MN, MA, MI, O, PE, PL, PA, PM, PS, PD, PR, QA, RO, RC, R, RS, RA, SN, SA, SR, SS, SY, ST, TE, TA, WM)
- GSE Engineering, Systems & Simulation, (GSE Systems), Columbia, MD (CM, DN, E, EC, FP, F, FT, HT, HF, IE, MN, O, OD, PE, P, PL, PA, PM, PD, QA, RO, RC, SN, SA, SR, SS, SY, ST, TE)
- GSE Solutions, (GSE Systems), Columbia, MD (AU, CM, CD, CS, CC, DE, DN, EP, E, EC, FP, F, HT, HF, IE, LR, MN, MA, MI, O, OD, PL, PA, PM, RC, SS, SY, ST, TE, TA)
- GSE Workforce Solutions, Training Services, (Formerly known as Hyperspring), Columbia, MD (SS, TE)
- Hansell Tierney, Inc. (WBE), Mercer Island, WA (C, CM, CD, CS, CC, CA, DN, FP, F, FT, HT, HY, IE, IM, IS, LR, L, MI, OD, PE, PS, PD, PP, PT, RM, RC, R, RS, RA, SN, SA, SR, SH, SS, SY, ST, TE)
- Heatric Division of Meggitt (UK) Ltd., Poole, Dorset, United Kingdom (HT)
- Hexion Inc., Columbus, OH (CO)
- HGP Inc., Greenville, SC (IS, MA)
- Highland TEMS, LLC, Marietta, GA (CD, CC, DN, HT, HF, HY, IE, MI, O, OD, PA, PP, RO, RA, SN, SA, SR, SY)
- ◆Holtec International, Camden, NJ (CD, CH, CE, DE, F, FT, HT, HY, HD, L, P, QA, RC, SE, SH)
- Hot Cell Services Corp., (HCS Corp.), Kent, WA (DN, MN, SH)
- Hydro, Inc., (HydroAire Services Division), Chicago, IL (HY, MN, PM, SP)
- ◆I.C.E. Service Group, Inc., Moon Township, PA (DE, E, PP, QA, RD, WM)
- Idom Consulting, Engineering, Architecture S.A.U., Bilbao, Spain (AC, CO, CD, CE, DN, EA, EP, FP, F, HT, HY, IE, IS, LP, MA, M, OA, P, PL, PS, PP, QU, QA, RE, R, RS, RA, SN, S, SE, SH, SS)
- ILD, Inc., Baton Rouge, LA (DN, HT, P, PA, ST)
- Imperia Engineering Partners LLC, Milford, MA (CO, CD, CS, CC, CA, DE, DN, E, EC, FT, HT, HY, HD, IP, IE, L, LP, MA, N, OA, O, OM, P, PL, PM, PS, PP, QU, QA, RC, R, RA, SN, SA, S, SE, SH, SI, SY, ST, TA)
- In-Place Machining Company, LLC, Blue Ash, OH (WM)
- InfoTech NorthStar, Richland, WA (CS)
- Integra Services Technologies Inc., Sarnia, Ontario, Canada (P)
- Interdevelopment, Inc., Falls Church, VA (EA, PS, PP)
- Intertek, Santa Clara, CA (EA, HT, IP, P, RC)
- InVizion LLC, Oak Ridge, TN (PP, RA)
- ISO-PACIFIC Remediation Technologies, Inc., Richland, WA (CS, CE, DC, DE, RD, RE, SH)
- Jacobs, (CH2M HILL Nuclear Business Group), (CH2M HILL International Nuclear Services, Ltd.), (CH2M HILL Constructors, Inc.), (Jacobs Engineering), (Jacobs), Dallas, TX (CM, DC, DE, EP, E, FT, HF, IP, LR, OD, PP, RC, WM)
- James Fisher Technologies, Loveland, CO (DC, DE, DN, HY, SY)
- Jensen Hughes, Baltimore, MD (CS, DN, EP, E, FP, HF, HD, LR, L, O, PE, P, PL, PM, QA, RC, R, RA, S, SE, SS, SI, SY, TA, V)
- Joseph Oat Corp., Camden, NJ (E, HT, HD, P, PS, QA, SE, SP)
- KCI Engineering Consultants, Downers Grove, IL (DN, LR, OA, PL, QU)
- Kinectrics Inc., Toronto, Ontario, Canada (C, CO, CD, DC, DE, E, EC, F, HF, HD, IP, IE, LR, L, LP, MN, OM, PL, PA, PM, QU, QA, RD, RE, RC, R, RS, RA, SN, SA, SE, SH, SP, SY, ST, TE, TA, WM, WT)
- Kinometrics, Inc., Pasadena, CA (SE)
- Klein Consulting LLC, Norwich, CT (AU, F, FT, HF, IP, MA, PS, QA, TE)
- Knowledge Relay, Cypress, CA (PP)
- L3Harris MAPPs Inc., (Power Systems and Simulation), Montreal, Quebec, Canada (SS)
- LATA, Albuquerque, NM (DC, DE, ES, E, IP, IE, PP, QA, RC, RA, WM)
- Leak Testing Specialists, Inc., Orlando, FL (QA)
- LeBlond and Associates, LLC, Libertyville, IL (CC, L, RC, SN)
- Lightbridge Corporation, Reston, VA (EA, F, IP, L, PP, RC, RS)
- Longenecker & Associates, Inc., Las Vegas, NV (BD, CM, CE, DC, DE, E, PE, PP, QA, RD, RE, RA, WM)
- Lucideon, Schenectady, NY (CO, QU, WM)
- The Macris Group, Mystic, CT (HF, TE)
- MarShield Radiation Shielding, (Div. of Marswell Metal Industries Ltd.), Burlington, Ontario, Canada (SH, WM)
- Materials and Chemistry Laboratory, Inc., (MCLinc), Oak Ridge, TN (E)
- Mechanical Solutions, Inc., Whippany, NJ (EC, HD, V)
- Mega-Tech Services, LLC, Cooksburg, PA (DC, MN)
- Meridian Services Group, (formerly Work Management, Inc., and High Bridge Associates, Inc.), Chattanooga, TN (DE, EA, IP, MN, O, OD, OM, PP, PT, RA, TE)
- Merrick & Company, Greenwood Village, CO (AC, C, CD, DN, IE, P, SE, SH, WM, WT)
- METOIL, Praha, Czech Republic (The) (C)
- MillenniTEK, LLC, Knoxville, TN (DN, FT, MI, QU)
- Millsap Electronics, Mason, OH (IE)
- Mirion Technologies (Canberra) Inc., Meriden, CT (CE, DC, DE, EP, E, MI, O, PP, RD, RE, RM, SI, WM)
- Mirion Technologies (MGPi H&B) GmbH, (Mirion Technologies), Munich, Germany (AU, EC, IE, L, PL, QU, QA, RD, RE, RC, R, RS, SN, SR, SE, SH, SS, SY, ST)
- Mitsubishi Nuclear Energy Systems, Inc., (A Sub. of Mitsubishi Heavy Industries, Ltd.), Charlotte, NC (AC, C, CO, CM, CD, CS, CC, CA, CH, CE, DC, DE, DN, ES, EA, EP, E, EC, FP, F, FT, HT, HF, HY, HD, IP, IE, IM, IS, LR, L, LP, MN, MA, MI, M, N, O, OD, OM, PE, PH, P, PL, PA, PM, PS, PP, PT, PR, QU, QA, RD, RE, RM, RO, RC, R, RS, RA, SN, SA, SR, S, SE, SH, SS, SI, SP, SY, ST, TE, TA, WM, WT)
- Murray and Trettel, Inc., Palatine, IL (EP, E, M)
- ◆NAC International Inc., Peachtree Corners, GA (CD, CS, CE, EA, F, FT, HT, MI, PE, QA, RM, SH, WM)
- NAC LPT LLC, Mars, PA (E, WM)
- NAC Philotechnics, Ltd., Oak Ridge, TN (DC, DE, RD, SH, WM)
- National Inspection & Consultants, Fort Myers, FL (CC, CA, IE, L, MN, MA, OM, PM, PS, PP, PR, QA, RM, TE)
- Navarro, Oak Ridge, TN (BD, CM, CA, DC, DE, EP, LR, MN, PP, PT, QA, RD, RS, RA, TA, WM, WT)
- Neptune and Company, Inc., Lakewood, CO (CS, ES, EA, E, QA, RM, RC, RA, TA, WM)
- ◆Netsch Instruments North America LLC, Burlington, MA (ES)
- New Millennium Nuclear Technologies International, Lakewood, CO (WM)
- North Wind Group, Idaho Falls, ID (WM)
- NSSI/Recovery Services Inc., Houston, TX (DC, DE, E, LR, L, RE, RC, WM, WT)
- NucAdvisor, Courbevoie, France (EA, E, RC, SN)
- Nuclear Care Partners, Grand Junction, CO (PH)
- Nuclear Economics Consulting Group (NECG), Alexandria, VA (EA, PS, PR, RA)
- Nuclear Shielding Supplies & Service, Tucson, AZ (SH)
- Nuclear-21, Waasmunster, Belgium (AU, BD, OD, PD, RC)
- NuclearConsultants.com, Ann Arbor, MI (CD, CS, CE, DN, F, FT, IP, SN, SR, SH, WM)
- NuclearN, Phoenix, AZ (MI, O, OD, OM, PE, PH, PS, PP, QA, RC, RA, SN, SA, SR, TA)
- Nucleonova S.L., Valencia, Spain (CD, IS, MA, OA, PL, PS, QU, QA, RO, SP, SY)
- ◆NUCON International, Inc., Columbus, OH (AC, C, CD, E, WM, WT)
- Numerical Advisory Solutions, LLC, Cary, NC (CD, CS, CC, DE, DN, EA, EC, FP, HT, HF, HY, IE, LR, L, LP, MN, P, PL, PA, PS, PP, QA, RC, RA, SN, SA, SR, S, SE, ST)
- NuSource LLC, Alexandria, VA (CD)
- Oakleaf Environmental, Inc., Knoxville, TN (DE, E, MA, RE, RC, WM)
- Orano USA, Bethesda, MD (DC, DE, FT, L, WM)
- Pacific Development Services Inc., Carson City, NV (BD, DE, EA, F, FT, IP, WM)
- Pajarito Scientific Corp., Santa Fe, NM (CE, DC, DE, F, FT, IS, OM, QU, RD, RE, SH, WM)
- PAR Systems, LLC, Saint Paul, MN (CD, CH, SE, SY, WM)
- ◆Paragon Energy Solutions, (Paragon), Fort Worth, TX (CD, IE, LR, L, MN, PS, QU, SE)
- Paschal Solutions, Inc., Knoxville, TN (CE, DN, FP, MA, O, PP, RE, RC, SN, SH, TA)
- Paxton & Vierling Steel, Carter Lake, IA (SN, SE)
- Perma-Fix Environmental Services, Inc., Oak Ridge, TN (RE)
- Pioneer Motor Bearing Co., Kings Mountain, NC (HD)
- Platom Oy, Mikkeli, Finland (DN, LR, L)
- PMT Nuclear, Woodridge, IL (AC, P, QU, QA, SE)
- Power & Energy Systems Services, Oradell, NJ (CD, EC, IP, PL, PA, TE, TA)
- Power Generation Integrated, (PGICL), Etobicoke, Ontario, Canada (AU, BD, CC, DN, IP, MI, OD, PL, PA, PD, PP, QA, RC, SY, TE, WM)
- Powerfect Service, Inc., Brick, NJ (HT, MN, O, PM, QA)
- ◆Precision Custom Components, LLC., (DC Fabricators), York, PA (CD, SE)
- ◆Preferred Engineering Corp., (Sub. of Preferred Utilities Mfg. Corp.), Danbury, CT (CC, CH, FT, MN, SH)
- Preferred Quality Services, Inc., Jacksonville, FL (QU, QA)
- Premier Technology, Inc., Blackfoot, ID (RD, SH)
- Primm Consulting, LLC, Knoxville, TN (CS, CE, EA, F, SN, SH)
- Prospect Law Ltd., London, United Kingdom (DE, E, L, RC, RA)
- PROTEM USA LLC, Evergreen, CO (DE, MN, P, PL, PM)
- PTP Spent Fuel Services, LLC, Grand Island, NY (DE, FT, PP, WM)
- Radiation Protection Systems, (by Alpha Safety), Groton, CT (AC, DE, RE, SH)
- ◆Radiation Safety & Control Services, Inc., Seabrook, NH (CE, DC, DE, EP, E, IP, IE, LR, L, MA, O, OM, PM, PP, RD, RE, RC, RS, RA, SN, SA, SR, SH, SS, TE, TA, WM, WT)
- Radics LLC, Kropyvnytskyi, Ukraine (CD, CS, FP, MI, SN, SE)
- Radiological Solutions Inc., Rockdale, IL (E, RE, TA, WM, WT)
- Radium Inc., Waynesboro, VA (CM, HF, MN, OM, PE, PM, PP)
- Ray Termini & Associates LLC, Wheaton, IL (FT, PP)

◆ Denotes advertiser—see Index to Advertisers on pages 8–14

Red Wolf Associates, Cary, NC (DN, FP, HT, HY, HD, M, P, PL, PA, RE, RA, SN, SR, SH, SY, TE)  
 Remtech Inc., The Villages, FL (M)  
 ReNuke, Oak Ridge, TN (BD, DE, RD, RE)  
 Republic Services, Livonia, MI (EP, E)  
 Rexon Components, Inc., Beachwood, OH (RS)  
 Right Brain Security, Oswego, IL (DN, IP, MA, RA, S, TE)  
 Robatel Technologies, LLC, Roanoke, VA (DN, FT, WM)  
 Rogante Engineering Office, Civitanova Marche, Italy (AC, CO, DE, QA, RS)  
 S&K Logistics Services, Byron, GA (CM, CS, CA, EP, E, O, PE, PS, PP, PT, QA, RM, RC, RA, TE, TA, WM)  
 Sarens Nuclear & Industrial Services LLC, (Sarens), Houston, TX (CH)  
 Schulz Electric, Timken Power Systems, East Haven, CT (CH, MN, PM, QU)  
 J. L. Shepherd & Assoc., San Fernando, CA (SH)  
 Sidus Solutions LLC, San Diego, CA (CH, S, TE, WM)  
 Siempelkamp NIS, Alzenau, Germany (DE)  
 SIET, Piacenza, Italy (HT, HY, HD, IE, PE, PA, QU, QA, RS, SN, SA, SR, ST)  
 Sigma Science, Inc., Albuquerque, NM (CE, E, FP, FT, PP, QA, RD, RE, RS, RA, SN, SR, SH, SY, WM)  
 Howard L. Sobel, P.E., Oceanside, NY (CA, F, MA, OD, PR, QA, WM)  
 Solestiss, Kennebunkport, ME (BD, CM, CS, DE, DN, ES, EA, EP, E, F, IP, LR, L, MN, MA, MI, O, OD, OM, PE, PL, PA, PM, PS, PD, PP, PT, PR, QU, QA, RM, RO, RC, RA, SN, SA, SI, TE, TA, WM)  
 Sonic Systems International, LLC, Houston, TX (QU, QA)  
 Southwest Research Institute, San Antonio, TX (AC, C, CO, CD, CS, CE, DC, DE, ES, E, EC, FP, F, FT, HT, HF, IP, LR, L, LP, M, N, P, PL, QA, RE, RC, R, RS, RA, SN, SR, S, SE, SH, SI, SY, ST, TE, TA, WM)  
 Special Electronics & Designs Inc., (SED Inc.), Kincardine, Ontario, Canada (CM)  
 ◆SSM Industries, Inc., (Nuclear Div.), Pittsburgh, PA (CD)  
 Standish Technologies International, Export, PA (CS)  
 ◆Strategic Packaging Systems, (I.C.E. Packaging Company, LLC), Madisonville, TN (DE, RD)  
 Success Staging International, LLC, Evans, GA (CC, CA, ES, FL, HF, MA, MI, PA, PM, PS, PP, PT, QU, RO, SR, SI, ST, WM)  
 Superconductivity Innovations, New Windsor, NY (IE, RS)  
 ◆System One, Pittsburgh, PA (CO, CS, CC, CA, CE, DE, DN, EP, E, EC, FP, F, FT, IP, IE, IS, LR, L, MN, MI, O, OM, P, PL, PA, PM, PS, PP, PT, QA, RO, RC, R, RS, RA, SN, SA, SR, SI, SY, ST, TE, TA)  
 Teledyne Brown Engineering, Inc., Huntsville, AL (SI, SY, ST)  
 TerranearPMC, LLC, Exton, PA (DE, E, RC)  
 Tetra Tech Inc., Richland, WA (AU, BD, CO, CD, CS, CC, CA, CH, CE, DC, DE, DN, ES, EA, EP, E, EC, FT, HT, HF, HY, HD, IP, IE, IM, IS, LP, MN, MA, N, O, P, PL, PA, PM, PP, PT, QU, QA, RD, RE, RC, R, RA, SN, SA, SR, SE, SH, SI, SY, TA, V, WM, WT)  
 The Delphi Groupe, Inc., Austin, TX (CM, CS, CC, CA, DC, DE, EP, E, FP, L, MA, PP, RD, RE, RM, RC, RA, SN, SA, SR, SH, SI, TE, WM)  
 ◆Thermal Engineering International (TEI), Cerritos, CA (HT, PA)  
 Theseus Quality Assurance, LLC, Richland, WA (QA, TE)  
 TLG Services, LLC, (sub. of Entergy Corp.), Bridgewater, CT (DC, DE, EA, LR, PP, RD, RE, WM)  
 Toshiba America Energy Systems Corp., West Allis, WI (C, CO, CD, CS, CC, CE, DC, DE, DN, EC, F, HT, HY, HD, IE, LR, L, MN, MI, O, OM, PE, P, PL, PA, PM, PS, PP, QA, RD, RE, R, RS, RA, SN, SA, SR, SE, SH, SS, SY, TA, WM, WT)  
 TRAD - RayXpert, Labège cedex, France (CD)

TradeWind Services LLC, Richland, WA (C, CM, CD, CS, CA, CH, CE, DC, DE, DN, ES, EP, E, FP, FL, F, FT, HF, IP, IE, IM, IS, LR, L, MN, MA, MI, O, OD, PE, PH, P, PM, PS, PP, PT, QU, QA, RD, RE, RM, RO, RC, R, RS, RA, SN, SA, SR, S, SH, SS, SY, TE, TA, WM)  
 Transco Products Inc., Streator, IL (FP)  
 TransWare Enterprises Inc., St. Louis, MO (LR, PL, PP, QU, QA, RD, SH)  
 Trust Manufacturing, LLC, Euclid, OH (QU, QA)  
 TSSD Services, Inc., Sidney, ME (DC, DE, OD, PE, PP)  
 Tyne USA Inc., Jacksonville, FL (DC, DE, DN, F, IE, OA, P, PL, QU, RD, RO, SN, SR, ST)  
 ◆Ultra Energy, (Weed Instrument), Round Rock, TX (PL, SN)  
 United Engineers & Constructors, Inc., (Sub. of Imperia Engineering Partners), Mount Laurel, NJ (DN, FP, LR, MN, P, PL, QA)

University of Bristol, (Interface Analysis Centre) (South West Nuclear Hub), Bristol, United Kingdom (CO, DC, DE, ES, E, P, RS, RA, SE, WM, WT)  
 Utilities Service Alliance (USA), Overland Park, KS (PS, SN)  
 UxC, LLC, Roswell, GA (CD, DN, EA, F, IP, PS, RS)  
 vgbe energy service GmbH, Essen, Germany (TE)  
 Volian Enterprises, Inc., Murrysville, PA (CC, EP, HT, HF, L, MI, O, SR, TE)  
 Vysus Group, Houston, TX (L, RC, SN, WM)  
 Westinghouse Electric Co. LLC, Cranberry Township, PA (AC, C, CO, CD, CS, CC, CH, DC, DE, DN, EP, E, EC, F, FT, HT, HY, IP, IE, IM, LR, L, MN, MA, MI, O, OM, PE, P, PL, PA, PM, PS, PP, QU, QA, RD, RE, RC, RA, SN, SA, SR, S, SE, SH, SS, SP, SY, ST, TE, TA, WM, WT)



**Tailored  
 Expertise  
 Just a  
 Few Clicks  
 Away**

**Find the right expert for any aspect of the nuclear fuel cycle with NAC International's Global Network of Consultants**

NAC's team of nuclear industry experts combines worldwide industrial experience with global reach, detailed market analysis, and deep technical expertise. They collectively represent more than 500 years of nuclear industry experience, across the U.S. and around the world.

 **NAC  
 INTERNATIONAL**  
[www.nacintl.com](http://www.nacintl.com)

**CONTACT:** Dave Culp, VP Consulting  
 T: +1 980-253-3591 | [dculp@nacintl.com](mailto:dculp@nacintl.com)

- ◆ Westinghouse Electric Company LLC, (Westinghouse Parts Business), New Stanton, PA (E, SE)
  - ◆ WMG, Inc., Peekskill, NY (CS, DC, DE, E, FT, RD, RE, RC, SH, WM, WT)
- WTM Valves and Services - Hammel Dahl, (Div. of Wright Technical Marketing), Lewisburg, PA (CD, IP, PT, QU, SP)
- Zachry Nuclear Engineering, Charlotte, NC (M, RD, RA, SS)

## 14300 Containers

- B Bulk
  - CF Casks, Filter Transfer
  - CP Casks, Post-Accident Sample
  - CR Casks, Radwaste
  - SF Casks, Spent-Fuel Shipping
  - CS Casks, Spent-Fuel Storage
  - CO Component
  - CY Cylinders, UF6
  - DB Drum Breather Filters
  - DL Drum Liners/Inserts
  - D Drums
  - FF Fresh Fuel Shipping/Storage
  - GA Gamma Source Shipping
  - GS Gamma Source Storage
  - G Groups 1, 2 & 3 Containers (per IAEA)
  - HI High-Integrity (HIC)
  - L Laundry Shipping/Storage/Issue Containers
  - LI Liners/Inserts, LSA Containers
  - IA LSA Containers, IAEA
  - LS LSA Containers, Strong-Tight
  - NE Neutron Source Shipping
  - NS Neutron Source Storage
  - OH On-Site Storage Containers, High-Level
  - OL On-Site Storage Containers, Low-Level
  - O Overpacks
  - SS Soft-Sided/Flexible
  - S Soil
  - TA Type A Containers
  - TB Type B Containers
  - TC Type C Containers
- AECON-WACHS, (U.S. Div. of Aecon Nuclear), Jackson, SC (CO, D, OL, O, TA, TB)
- Aaron Nuclear Services, (Veolia Nuclear Solutions Federal Services - Aaron), Wampum, PA (LS, OL)
- ◆ Alphasource, Inc., Philadelphia, PA (DL)
- F.N. Anderson & Assoc., Forest, VA (SF, CS, FF, TA, TB)
- ◆ AVANTech, LLC, Columbia, SC (CF, CR, CO, DL, G, HI, LI, IA, LS, OH, OL, O, TA)
- Babcock Services, Inc., Kennewick, WA (CR, CS, O)
- Baker Industries, a Lincoln Electric Company, Macomb, MI (B, CF, CP, CR, SF, CS, CO, CY, DL, D, FF, GA, GS, G, HI, NE, NS, OH, OL, TA, TB, TC)
- Bilfinger Noell GmbH, (Dept. BEV), Wuerzburg, Germany (D)
- BWX Technologies, Inc., Lynchburg, VA (CR, SF, CS, CO)
- Campoverde srl, Milano, Italy (GA)
- Carolina Fabricators, West Columbia, SC (B, CF, CP, CR, SF, CS, CO, DL, D, FF, O)
- Central Research Laboratories, Red Wing, MN (DL)
- Coastal Network, Inc, Charlottesville, VA (D, LS)
- Consolidated Power Supply, (Div. of Consolidated Pipe & Supply Co., Inc.), Birmingham, AL (LI)
- Container Products Corporation, Wilmington, NC (B, CF, CR, SF, CS, DL, D, G, HI, L, LI, IA, LS, OH, OL, O, TA)
- Container Technologies Industries, LLC, Helenwood, TN (B, CR, CO, D, G, HI, LI, IA, LS, OH, OL, O, TA, TB, TC)
- Croft Associates Ltd, Abingdon, Oxfordshire, United Kingdom (CR, CO, DB, DL, D, GA, GS, G, HI, LI, IA, LS, OH, OL, O, TA, TB, TC)
- ◆ Curtiss-Wright Nuclear Division, Brea, CA (SF)
- Curtiss-Wright Nuclear Division, NETCO, Danbury, CT (SF)
- ◆ DuBose National Energy Services, Inc., Clinton, NC (B, CR, SF, CS, CO, D, GS, OL, O)

- Dufrane Nuclear Shielding Inc., (Dufrane Nuclear Inc.), Winsted, CT (B, CF, CP, CR, DL, D, GA, GS, HI, LI, LS, NS, OH, OL, O, TA, TB)
- E.S. Fox Limited, Niagara Falls, Ontario, Canada (B, OH, OL, O)
- Eastern Technologies, Inc., (OREX; PolyZolv), Ashford, AL (L, LS)
- ◆ Element Nuclear (NTS Labs), (Nuclear Engineering & Test Services), Huntsville, AL (CO)
- Energy Steel, Rochester Hills, MI (SF, CS, OH, OL, TA, TB)
- Energyn Corporation, (Sales Operation), Gunsan, Korea (The Republic of) (D)
- ◆ EnergySolutions, Salt Lake City, UT (B, CF, CP, CR, SF, CS, CO, DL, D, GA, HI, LI, IA, LS, OH, OL, O, SS, S, TA, TB)
- Equipos Nucleares, S.A., S.M.E, Maliaño (Cantabria), Spain (CR, SF, CS, NE, NS, TB)
- FabOhio, Inc., Uhrichsville, OH (DL)
- ◆ Framatome Inc., (North American Headquarters), Lynchburg, VA (CY, FF, O)
- Frontier Technology Corp., Xenia, OH (NE, TA)
- FuseRing Inc., London, Ontario, Canada (CS)
- GE Hitachi Nuclear Energy, Wilmington, NC (CF, CP, SF, CS, FF, GA, GS, NE, NS, OH, OL, O, TA, TB)
- General Plastics Mfg. Co., Tacoma, WA (DL, LI, TA, TB)
- Glidewell Specialties Foundry Co., Calera, AL (CR)
- GNS Gesellschaft fur Nuklear-Service mbH, Essen, Germany (CR, SF, CS, DL, D, OH, OL)
- H. Butting GmbH & Co. KG, Wittingen-Knesebeck, Germany (CR, SF, CS, CO, OH, OL)
- ◆ Holtec International, Camden, NJ (CR, SF, CS, OH, OL, O, TA)
- Hopewell Designs, Inc., Alpharetta, GA (CP, CR, GA, GS, NE, NS, OL, TA)
- ◆ I.C.E. Service Group, Inc., Moon Township, PA (B, CR, CO, DB, DL, D, LI, IA, LS, O, SS, S, TA, TB)
- Joseph Oat Corp., Camden, NJ (CR, SF, CS, CY, DL, D, GA, GS, G, HI, LI, IA, LS, NE, NS, OH, OL, O, TA, TB)
- Lancs Industries, Albuquerque, NM (DB, DL, SS)
- Landstar, Burlington, KY (D, IA)
- Leak Testing Specialists, Inc., Orlando, FL (TB)
- ◆ Major Tool & Machine, (A Precinmac Company), Indianapolis, IN (B, CF, CP, CR, SF, CS, CO, CY, FF, GA, GS, NE, NS, OH, OL, O, TB)
- MarShield Radiation Shielding, (Div. of Marswell Metal Industries Ltd.), Burlington, Ontario, Canada (CR, SF, CS, D, GA, GS, G, OH, OL)
- Mitsubishi Nuclear Energy Systems, Inc., (A Sub. of Mitsubishi Heavy Industries, Ltd.), Charlotte, NC (B, CF, CP, CR, SF, CS, CO, CY, DB, DL, D, FF, GA, GS, G, HI, L, LI, IA, LS, NE, NS, OH, OL, O, SS, S, TA, TB)
- Mohawk Safety, Inc., Manchester, CT (DL, D, O)
- ◆ NAC International Inc., Peachtree Corners, GA (B, CR, SF, CS, FF, IA, LS, OH, OL, O, SS, TA, TB)
- NAC LPT LLC, Mars, PA (B, LS, OL, TA)
- NAC Philotechnics, Ltd., Oak Ridge, TN (GA, GS)
- NAES Power Contractors, Inc., Sheloceta, PA (CS)
- NFT, (by Alpha Safety Group), Golden, CO (O, TB)
- NSSI/Recovery Services Inc., Houston, TX (CR, D, GA, GS, NE, NS, OH, OL, O, TA)
- Nuclear Shielding Supplies & Service, Tucson, AZ (OH, OL)
- NuclearConsultants.com, Ann Arbor, MI (SF, CS, CY, FF, O)
- NuSource LLC, Alexandria, VA (CF, CR, CO)
- Orano Federal Services, Charlotte, NC (CR, SF, CS, DL, D, FF, NE, OH, O, TA, TB, TC)
- Orano TN, Columbia, MD (CR, SF, CS, CO, OH, OL, O, TA, TB, TC)
- Orano USA, Bethesda, MD (CR, SF, CS, CY, D, FF, OH, OL, O, TA, TB, TC)
- Pacific Development Services Inc., Carson City, NV (B, CF, CP, CR, SF, CS, DL, D, GA, G, IA, LS, OH, OL, O, TA, TB)
- ◆ PacTec, Inc., Clinton, LA (B, DL, G, LI, IA, LS, OH, OL, O, SS, S, TA)
- Pajarito Scientific Corp., Santa Fe, NM (DB, FF)

- ◆ Petersen Inc. (A Precinmac Company), Ogden, UT (B, CF, CR, SF, CS, CY, LS, OH, OL, O, TA, TB)

### See advertisements on pages 13 and 73

- ◆ Precision Custom Components, LLC., (DC Fabricators), York, PA (CR, SF, CS, OH, O)
- Premier Technology, Inc., Blackfoot, ID (CR, SF, CS, TA, TB)
- PTP Spent Fuel Services, LLC, Grand Island, NY (CR, SF, CS, OH, OL)
- R&G Laboratories, Inc., Tampa, FL (DB)
- Radiation Protection Systems, (by Alpha Safety), Groton, CT (CF, CR, GA)
- ◆ Radiation Safety & Control Services, Inc., Seabrook, NH (GA, TA)
- Radium Inc., Waynesboro, VA (B, CO, SS)
- ◆ Reef Industries, Inc., (Griffolyon, Div. of Reef Industries, Inc.), Houston, TX (B, DL, LI, LS, OL, O, SS, TA)
- Rich Industries Inc., New Philadelphia, OH (DL)
- Robatel Technologies, LLC, Roanoke, VA (B, CF, CP, CR, SF, CS, CO, CY, FF, GA, GS, G, IA, LS, NE, NS, OH, OL, O, TA, TB)
- Rousselet-Robatel, Pittsfield, MA (CR)
- Sarens Nuclear & Industrial Services LLC, (Sarens), Houston, TX (SF, CS)
- Scientific Sales, Inc., Oak Ridge, TN (B, CY, DB, DL, D)
- Seafab Metals Co., (Div. of The Doe Run Co.), Casa Grande, AZ (CR, SF, CS)
- J. L. Shepherd & Assoc., San Fernando, CA (CF, CP, GA, GS, NE, NS, O, TA)
- Siempelkamp NIS, Alzenau, Germany (CR)
- SKODA JS a.s., Plzen, Bolevec, Czech Republic (The) (CS)
- Skolnik Industries, Chicago, IL (D, O, TA)
- ◆ Strategic Packaging Systems, (I.C.E. Packaging Company, LLC), Madisonville, TN (B, CR, SF, CO, DL, D, L, LI, IA, LS, O, SS, S, TA, TB)
- Teledyne Brown Engineering, Inc., Huntsville, AL (B, CF, CP, CR, SF, CS, CO, CY, DB, DL, D, FF, GA, GS, G, HI, L, LI, IA, LS, NE, NS, OH, OL, O, SS, S, TA, TB)
- Toshiba America Energy Systems Corp., West Allis, WI (CF, CP, CR, SF, CS, CO, FF, G, IA, LS, O, TA, TB)
- Transco Products Inc., Streator, IL (CF, CR, OH, OL, TC)
- TW Metals - Nuclear Materials Solutions, Linden, MI (CR, SF, CS, OH, OL, O, TA, TB)
- UniTech Services Group Europe, (Sub. of UniTech Services Group USA), Coevorden, Netherlands (The) (L)
- ◆ UniTech Services Group, Inc., (Div. of UniFirst Corp.), Longmeadow, MA (IA, LS)
- ◆ Wagstaff Applied Technologies, Spokane, WA (B, CR, SF, CS, CO, CY, DL, FF, GA, GS, HI, LI, OH, OL, O)
- Waste Control Specialists LLC, Andrews, TX (B, CR)
- Waste Control Systems, Inc., Phoenix, MD (DL, D, HI, IA, LS, O, TA)
- Westinghouse Electric Co. LLC, Cranberry Township, PA (CO, FF, NE, NS)
- ◆ Westinghouse Electric Company LLC, (Westinghouse Parts Business), New Stanton, PA (SF, CS)
- ◆ WMG, Inc., Peekskill, NY (CO, LI, IA, LS, OH, OL, TA, TB)

## 14810 Containment Structures, Reactor

- C Conventional
  - FV Filtered Venting
- AECON-WACHS, (U.S. Div. of Aecon Nuclear), Jackson, SC (C)
- Baker Industries, a Lincoln Electric Company, Macomb, MI (C)
- Bilfinger Noell GmbH, (Dept. BEV), Wuerzburg, Germany (C, FV)
- Carolina Fabricators, West Columbia, SC (C, FV)
- Centronic Ltd., Surrey, United Kingdom (C, FV)
- ◆ Framatome Inc., (North American Headquarters), Lynchburg, VA (C, FV)
- GE Hitachi Nuclear Energy, Wilmington, NC (C)
- ◆ Major Tool & Machine, (A Precinmac Company), Indianapolis, IN (C)

## ◆ Denotes advertiser—see Index to Advertisers on pages 8–14

Mitsubishi Nuclear Energy Systems, Inc., (A Sub. of Mitsubishi Heavy Industries, Ltd.), Charlotte, NC (C, FV)

- ◆NUCON International, Inc., Columbus, OH (FV)
- NuSource LLC, Alexandria, VA (C)
- Pajarito Scientific Corp., Santa Fe, NM (FV)
- Paxton & Vierling Steel, Carter Lake, IA (C)
- ◆Precision Custom Components, LLC., (DC Fabricators), York, PA (C)
- Toshiba America Energy Systems Corp., West Allis, WI (FV)

**14950 Control Devices & Systems**

A Accelerator Systems  
F Flow  
L Liquid Level  
P Pressure  
PL Programmable Logic  
S Strain, Stress-Rate  
SS Surge Suppression Device  
T Temperature  
V Vacuum

Automation Products, Inc., (Dynatrol Div.), Houston, TX (L)

Basic E, Inc., Charlotte, VT (F, L, P, PL, SS, T, V)

- ◆Curtiss-Wright Nuclear Division, Brea, CA (F, L, P, T)
- Curtiss-Wright Nuclear Division, QualTech NP, Cincinnati, OH (F, L, P, T)

- ◆Element Nuclear (NTS Labs), (Nuclear Engineering & Test Services), Huntsville, AL (F, L, P, PL, T)

Encorus Group, Springville, NY (P, PL)

FCI-Fluid Components International, San Marcos, CA (F, L, T)

- ◆Framatome Inc., (North American Headquarters), Lynchburg, VA (F, L, P, PL, S, T)
- GE Hitachi Nuclear Energy, Wilmington, NC (F, L, P, S, T)

GLSEQ, LLC, Huntsville, AL (F, L, P, SS, T)

KROHNE, (KROHNE Nuclear), Romans-sur-Isère, France (F, L, P, T)

Mirion Technologies (Canberra) Inc., Meriden, CT (L, PL)

- ◆Mirion Technologies (IST) Corp., (Sensing Systems Div.), Horseheads, NY (V)
- Mirion Technologies (MGPI H&B) GmbH, (Mirion Technologies), Munich, Germany (F, T)

Mirion Technologies, Inc., (Sensing Systems Div.), Atlanta, GA (F, L, P, PL, V)

Mitsubishi Nuclear Energy Systems, Inc., (A Sub. of Mitsubishi Heavy Industries, Ltd.), Charlotte, NC (A, F, L, P, PL, S, SS, T, V)

- ◆OTEK Corp., Tucson, AZ (A, F, L, P, PL, S, SS, T, V)

- ◆Paragon Energy Solutions, (Paragon), Fort Worth, TX (F, L, P, PL, T, V)

- ◆RdF Corporation, Hudson, NH (T)
- Schulz Electric, Timken Power Systems, East Haven, CT (PL)

Teledyne Brown Engineering, Inc., Huntsville, AL (S)

Temp-Pro Inc., Northampton, MA (T)

THERMOCOAX SAS, Caligny, France (T)

Thinklogical, A Belden Brand, Milford, CT (A, F, L, P, PL, S, SS, T, V)

Toshiba America Energy Systems Corp., West Allis, WI (A)

Tyne USA Inc., Jacksonville, FL (A, F, L, P, PL, S, SS, T, V)

- ◆Ultra Energy, (Weed Instrument), Round Rock, TX (P, T)

VAT Group, San Jose, CA (F, P, V)

Westinghouse Electric Co. LLC, Cranberry Township, PA (F, L, P, T)

- ◆Westinghouse Electric Company LLC, (Westinghouse Parts Business), New Stanton, PA (L, P, T)

**15200 Control Equipment, Power Plant (Non-Reactor)**

Automation Products, Inc., (Dynatrol Div.), Houston, TX

- ◆Curtiss-Wright Nuclear Division, Brea, CA

Curtiss-Wright Nuclear Division, QualTech NP, Cincinnati, OH

- ◆Framatome Inc., (North American Headquarters), Lynchburg, VA
- GE Hitachi Nuclear Energy, Wilmington, NC
- Incap Electronics US, Inc., California, PA
- Mirion Technologies (Canberra) Inc., Meriden, CT

Mitsubishi Nuclear Energy Systems, Inc., (A Sub. of Mitsubishi Heavy Industries, Ltd.), Charlotte, NC

NuSource LLC, Alexandria, VA

- ◆OTEK Corp., Tucson, AZ
- Radics LLC, Kropyvnytskyi, Ukraine
- THERMOCOAX SAS, Caligny, France
- Thinklogical, A Belden Brand, Milford, CT
- Toshiba America Energy Systems Corp., West Allis, WI
- Westinghouse Electric Co. LLC, Cranberry Township, PA

**15300 Control Houses, Enclosed**

Mitsubishi Nuclear Energy Systems, Inc., (A Sub. of Mitsubishi Heavy Industries, Ltd.), Charlotte, NC

- ◆Westinghouse Electric Company LLC, (Westinghouse Parts Business), New Stanton, PA

**15600 Control Rod Drives**

BWX Technologies, Inc., Lynchburg, VA  
Consolidated Power Supply, (Div. of Consolidated Pipe & Supply Co., Inc.), Birmingham, AL

- ◆Framatome Inc., (North American Headquarters), Lynchburg, VA
- GE Hitachi Nuclear Energy, Wilmington, NC
- Lincoln Structural Solutions, Louisville, NE
- Mitsubishi Nuclear Energy Systems, Inc., (A Sub. of Mitsubishi Heavy Industries, Ltd.), Charlotte, NC

- ◆Paragon Energy Solutions, (Paragon), Fort Worth, TX

**STRATEGIC PACKAGING SYSTEMS**

- 1- 25 CYD soft-sided bags
- Custom overpacks
- Dewatering bags
- Macro encapsulation bags
- Stand alone bags
- IP-1 & IP-2 certified bags
- Made in the USA
- SBA HUBZone Certified

**FOR MORE INFORMATION:**

☎ 423-545-9505

✉ R.MORELAND@SPSONLINE.BIZ

🌐 WWW.SPSONLINE.BIZ

SKODA JS a.s., Plzen, Bolevec, Czech Republic (The)  
 Toshiba America Energy Systems Corp., West Allis, WI  
 ♦ Ultra Energy, (Weed Instrument), Round Rock, TX  
 Westinghouse Electric Co. LLC, Cranberry Township, PA  
 ♦ Westinghouse Electric Company LLC, (Westinghouse Parts Business), New Stanton, PA

**16000 Control Rods, Reactor**

3M Technical Ceramics, Inc., Quapaw, OK  
 Centronic Ltd., Surrey, United Kingdom  
 ♦ Framatome Inc., (North American Headquarters), Lynchburg, VA  
 GE Hitachi Nuclear Energy, Wilmington, NC  
 Lincoln Structural Solutions, Louisville, NE  
 MillenniTEK, LLC, Knoxville, TN  
 Mitsubishi Nuclear Energy Systems, Inc., (A Sub. of Mitsubishi Heavy Industries, Ltd.), Charlotte, NC  
 Nuclear Energy Components Ltd, Hope Valley, Derbyshire, United Kingdom  
 THERMOCOAX Inc., Alpharetta, GA  
 THERMOCOAX SAS, Caligny, France  
 Toshiba America Energy Systems Corp., West Allis, WI  
 ♦ Westinghouse Electric Company LLC, (Westinghouse Parts Business), New Stanton, PA

**16800 Converters, Time-to-Pulse-Height**

GE Hitachi Nuclear Energy, Wilmington, NC  
 ORTEC, Oak Ridge, TN  
 Westinghouse Electric Co. LLC, Cranberry Township, PA

**17200 Core Structurals, Reactor**

Baker Industries, a Lincoln Electric Company, Macomb, MI  
 ♦ Framatome Inc., (North American Headquarters), Lynchburg, VA  
 GE Hitachi Nuclear Energy, Wilmington, NC  
 Lincoln Structural Solutions, Louisville, NE  
 ♦ Major Tool & Machine, (A Precinmac Company), Indianapolis, IN  
 Mitsubishi Nuclear Energy Systems, Inc., (A Sub. of Mitsubishi Heavy Industries, Ltd.), Charlotte, NC  
 NuSource LLC, Alexandria, VA  
 SKODA JS a.s., Plzen, Bolevec, Czech Republic (The)  
 Toshiba America Energy Systems Corp., West Allis, WI

**17650 Corrosion Inhibitors**

Arkema, Inc., (formerly ATOFINA Chemicals, Inc.), King of Prussia, PA  
 Bakelite Synthetics, Atlanta, GA  
 Cortec Corp., Saint Paul, MN  
 ♦ Dominion Engineering, Inc., Reston, VA  
 Fuel Tank Maintenance Co., LLC, Cookeville, TN  
 General Magnaplate Corp., Arlington, TX  
 Hexion Inc., Columbus, OH  
 Lambda Technologies, (Surface Enhancement Technologies, LLC and Lambda Research, Inc.), Cincinnati, OH  
 Westlake Epoxy Inc., a Westlake Company, Stafford, TX

**17950 Counters, Detectors, Radiation**

A Alpha  
 B Beta  
 G Gamma  
 N Neutron  
 C Combinations of Above  
 DT Desk-Top  
 ER Dose Rate, Emergency Range  
 FS Floor-Standing  
 FL Flow  
 GM Geiger-Mueller Type  
 G Germanium Detectors  
 IC Ion Chamber Type  
 IS Ion-Implanted Silicon Detectors  
 LB Low-Background Alpha/Beta

M Modular  
 P Portable  
 PC Proportional Counters  
 SL Scintillation Counters, Liquid  
 SR Scintillation Counters, Radioimmunoassay  
 ST Scintillation Counters, Solid-State  
 SS Solid-State Semiconductor Type  
 WT Wipe Test Counters  
 X X-ray  
 3D PLUS, (Detection Systems), Versailles, France (G)  
 Advetage Solutions, El Segundo, CA (A, B, G, N, C, DT, ER, FS, FL, GM, G, IC, IS, LB, M, P, PC, SL, SR, ST, SS, X)  
 Aurum Technologies, Blackfoot, ID (C, ER, GM, P)  
 Berthold Technologies USA LLC, Oak Ridge, TN (A, B, G, N, C, DT, ER, FS, FL, GM, IC, IS, LB, M, P, PC, ST, WT, X)  
 Bertin Technologies, France (A, B, G, N, C, ER, GM, LB, P, PC, ST, SS)  
 Bevelacqua Resources, (Radiation Protection), Owens Cross Roads, AL (A, B, G, N, C, DT, ER, FS, FL, GM, G, IC, IS, LB, M, P, PC, SL, SR, ST, SS, WT, X)  
 ♦ Bot Engineering Ltd, Campbellville, Ontario, Canada (A, B, G, N, C, ER, FS, FL, IC, M, P, PC, SL, ST, SS, X)  
 CAEN SyS, (CAEN SpA), Viareggio, LU, Italy (C)  
 Centronic Ltd., Surrey, United Kingdom (A, B, G, N, C, ER, GM, IC, IS, LB, PC, SS, X)  
 DETEK, Temple Hills, MD (G, GM)  
 ♦ EnergySolutions, Salt Lake City, UT (A, B, G, N, C, ER, GM, IC, P, PC, SL, SR)  
 ENVINET GmbH, Munich/Haar, Germany (G, ER, GM, M, P, PC, ST)  
 Environmental Restoration Group, Inc., Albuquerque, NM (A, B, G, C, DT, ER, FS, GM, IC, P, PC, WT)  
 Gamma Reality Inc., Richmond, CA (G, N, C, ER, M, P, ST, SS)  
 GE Hitachi Nuclear Energy, Wilmington, NC (B, G, N, IC, PC)  
 General Atomics Electromagnetic Systems, San Diego, CA (B, G, ER, GM, IC, P, PC, SL, ST, SS)  
 GLESEQ, LLC, Huntsville, AL (A, B, G, N, C, LB, P, SS)  
 H3D, Inc., Ann Arbor, MI (G, N, C, DT, M, P, SS)  
 Health Physics Instruments, (Div. of Far West Technology), Goleta, CA (A, B, G, N, DT, ER, GM, IC, M, P, PC)  
 ♦ HI-Q Environmental Products Co., Inc., San Diego, CA (A, B, G, N, C, DT, ER, FS, FL, GM, IC, IS, LB, M, P, SR, ST, WT)  
 Interface Analysis Centre, University of Bristol, Bristol, United Kingdom (G)  
 ISO-PACIFIC Remediation Technologies, Inc., Richland, WA (A, B, N, ST)  
 James Fisher Technologies, Loveland, CO (A, B, G, N, C, DT, ER, FS, FL, GM, G, LB, M, P, ST)  
 LabLogic Systems, Inc., Chantilly, VA (A, B, G, ER, GM, SL)  
 ♦ LND, Inc., Oceanside, NY (A, B, G, N, C, DT, ER, FS, FL, GM, IC, M, P, PC, WT, X)  
 Ludlum Measurements, Inc., Sweetwater, TX (A, B, G, N, GM, IC, P, PC, ST)  
 Mazur Instruments, Castle Rock, CO (A, B, G, C, ER, GM, X)  
 Mirion Technologies (Camberra) Inc., Meriden, CT (A, B, G, N, C, DT, ER, FS, FL, GM, G, IC, IS, LB, M, P, PC, ST, SS, WT, X)  
 Mirion Technologies (IST Canada) ULC, (Formerly Mirion Technologies (IST Canada) Inc.), Cambridge, Ontario, Canada (G, N, C, IC, PC)  
 ♦ Mirion Technologies (IST) Corp., (Sensing Systems Div.), Horseheads, NY (G, N, C, IC, PC)  
 Mirion Technologies (MGPI H&B) GmbH, (Mirion Technologies), Munich, Germany (B, G, N, C, ER, GM, IC, M, PC, ST)  
 Mirion Technologies (Premium Analyse) SAS, Norroy Le Veneur, France (B)  
 Mirion Technologies, Inc., (Sensing Systems Div.), Atlanta, GA (G, N, C, IC, PC)  
 NETCo, Windsor, ME (X)  
 ORTEC, Oak Ridge, TN (A, G, N, C, DT, ER, FS, GM, G, IS, LB, M, P, PC, ST, SS)  
 ♦ OTEK Corp., Tucson, AZ (FL, PC, SS)

Overhoff Technology Corp., (A Div. of US Nuclear Corp.), Milford, OH (A, B, G, IC, PC, SR, WT)  
 Pajarito Scientific Corp., Santa Fe, NM (A, B, G, N, C, FS, G, M, P, PC)  
 ♦ Paragon Energy Solutions, (Paragon), Fort Worth, TX (G, N, C, IC, PC)

**See advertisement on cover 4**

Perma-Fix Environmental Services, Inc., Oak Ridge, TN (A, B, G, C, GM, LB, P, WT)  
 PHDS Co., Knoxville, TN (G, G, M, P, SS)  
 ♦ Photonis, Brive la Gaillarde Cedex, France (G, N, IC, PC)  
 Pylon Electronics Inc., (Instrument Manufacturing Div.), Ottawa, Ontario, Canada (A, P, WT)  
 ♦ Radiation Safety & Control Services, Inc., Seabrook, NH (A, B, G, N, C, ER, FS, GM, G, IC, IS, LB, M, P, PC, SL, SR, ST, SS, WT, X)  
 ReNuke, Oak Ridge, TN (A, B, G, N, C, DT, GM, G, IC, LB, M, P, PC, ST)  
 Rexon Components, Inc., Beachwood, OH (A, B, G, N, C, DT, ER, FS, GM, IC, LB, M, P, PC, SR, ST, SS, WT, X)  
 S.E. International, Inc., Summertown, TN (A, B, G, C, DT, ER, GM, P, ST, WT, X)  
 Scientific Sales, Inc., Oak Ridge, TN (A, B, G, N, C, DT, ER, FS, FL, GM, G, IC, IS, LB, M, P, PC, SL, SR, ST, SS, WT, X)  
 Technical Associates, (a Div. of US Nuclear Corp.), Canoga Park, CA (A, B, G, N, C, DT, ER, FS, FL, GM, G, IC, LB, M, P, PC, SL, SR, ST, SS, WT, X)  
 THERMOCOAX Inc., Alpharetta, GA (G, N)  
 THERMOCOAX SAS, Caligny, France (G, N)  
 Toshiba America Energy Systems Corp., West Allis, WI (G, N, C, DT, ER, FS, FL, G, IC, IS, M, P, PC, ST, SS, X)  
 Tyne USA Inc., Jacksonville, FL (A, B, G, N, C, DT, ER, FS, FL, GM, G, IC, IS, LB, M, P, PC, SL, SR, ST, SS, WT)  
 ♦ Ultra Energy, (Weed Instrument), Round Rock, TX (N)  
 University of Bristol, (Interface Analysis Centre) (South West Nuclear Hub), Bristol, United Kingdom (A, B, G, C)  
 US Nuclear Corp., (Technical Associates Sub.), (Overhoff Technology Corp. Sub.), Canoga Park, CA (A, B, G, N, C, DT, ER, FS, FL, GM, IC, LB, M, P, PC, SL, SR, ST, SS, WT, X)  
 Warrington, Inc., Pflugerville, TX (A, B, G, C, GM, IC, P, PC, ST, WT, X)  
 Westinghouse Electric Co. LLC, Cranberry Township, PA (A, B, G, N, C, GM, IC, PC)  
 ♦ Westinghouse Electric Company LLC, (Westinghouse Parts Business), New Stanton, PA (A, B, G, N, GM, G)  
 ♦ WMG, Inc., Peekskill, NY (A, B, G, C, DT, LB, M, P, SS)

**18400 Couplings (Pipe-Joining)**

AS Alloy Steel  
 CS Carbon Steel  
 SS Stainless Steel  
 BS Butt welded, Seamless  
 BW Butt welded, Welded  
 FS Forged Steel, Socket Weld  
 FT Forged Steel, Threaded  
 M Mechanical  
 NQ Nuclear Quality  
 U Unions  
 AECON-WACHS, (U.S. Div. of Aecon Nuclear), Jackson, SC (AS, CS, SS, BS, BW, FS, FT, M, NQ, U)  
 ♦ Boston Government Services, LLC (BGS), Oak Ridge, TN (NQ)  
 Carolina Fabricators, West Columbia, SC (AS, CS, SS, BS, BW, FS, FT, M, NQ, U)  
 Centronic Ltd., Surrey, United Kingdom (AS, CS, SS, BS, BW, FS, FT, M, NQ, U)  
 Consolidated Power Supply, (Div. of Consolidated Pipe & Supply Co., Inc.), Birmingham, AL (AS, CS, SS, BS, BW, FS, FT, M, NQ, U)  
 ♦ Curtiss-Wright Nuclear Division, Brea, CA (AS, CS, SS, BS, BW, FS, FT, M, NQ, U)  
 Curtiss-Wright Nuclear Division, Nova, Middleburg Heights, OH (AS, CS, SS, BS, BW, FS, FT, M, NQ, U)



◆ Denotes advertiser—see Index to Advertisers on pages 8–14

- ◆ DuBose National Energy Services, Inc., Clinton, NC (AS, CS, SS, BS, BW, FS, FT, M, NQ, U)  
Lincoln Structural Solutions, Louisville, NE (AS, CS, SS, BS, BW, FT, NQ)
- ◆ OTEK Corp., Tucson, AZ (NQ)
- ◆ Paragon Energy Solutions, (Paragon), Fort Worth, TX (AS, CS, SS, BS, BW, M, NQ, U)  
PMT Nuclear, Woodridge, IL (AS, CS, SS, BS, BW, FS, FT, M, NQ, U)  
Premier Technology, Inc., Blackfoot, ID (AS, CS, SS)
- ◆ SSM Industries, Inc., (Nuclear Div.), Pittsburgh, PA (AS, CS, SS, BS, BW, NQ)  
Technical Associates, (a Div. of US Nuclear Corp.), Canoga Park, CA (NQ)  
Tioga Pipe, Philadelphia, PA (AS, CS, SS, BS, BW, FS, FT, NQ, U)  
Trust Manufacturing, LLC, Euclid, OH (AS, CS, SS, BS, FT, M, NQ)  
TW Metals - Nuclear Materials Solutions, Linden, MI (AS, CS, SS, BS, BW, FS, FT, M, NQ, U)
- ◆ Westinghouse Electric Company LLC, (Westinghouse Parts Business), New Stanton, PA (AS, CS, SS, BS, BW, FS, FT, M, NQ, U)

**18590 Crane Safety Systems**

- AT Anti-Two-Blocking (Conversion)
- SF Single-Failure-Proof
- PAR Systems, LLC, Saint Paul, MN (AT, SF)
- REEL COH Inc., Canada (AT, SF)
- ◆ Westinghouse Electric Company LLC, (Westinghouse Parts Business), New Stanton, PA (AT, SF)

**18600 Cranes & Hoists**

- CS Control System Upgrade/Replacement
- CO Controls, Radio
- CC Cranes, Conventional, to 300-Ton Cap.
- CR Cranes, Conventional, to 500-Ton Cap.
- CH Cranes, Heavy-Lift, to 1000-Ton Cap.
- CX Cranes, Heavy-Lift, to 2500-Ton Cap.
- CY Cranes, Heavy-Lift, over 2500-Ton Cap.

- DG Double-Girder, Top-Riding
- E Electric
- FB Fuel Building Cranes (Cask Handling)
- G Gantry
- H Hand Chain-Operated
- LM Lug-Mounted Hoists
- MH Monorail Hoists
- NS Non-Safety-Related, Nuclear
- RS Radwaste Storage Facility
- SR Safety-Related, Nuclear
- SG Semi-Gantry
- SF Single-Failure-Proof
- ST Single-Girder, Top-Riding
- SU Single-Girder, Under-Riding
- SP Spent Fuel Pool Cranes
- TB Turbine Building Cranes

- ◆ American DND Inc., Grand Island, NY (CR, CX, RS)
- ◆ Barnhart Nuclear Services, Fairhope, AL (CR, CH, CX, G)  
Bilfinger Noell GmbH, (Dept. BEV), Wuerzburg, Germany (FB, RS, SR, SF, SP)
- ◆ Curtiss-Wright Nuclear Division, Brea, CA (E, H, NS)  
Curtiss-Wright Nuclear Division, QualTech NP, Cincinnati, OH (E, H, NS)  
Del Mar Avionics, (Hydra Set Div.), Irvine, CA (SR, SP, TB)  
Engineered Rigging, Russellville, AR (CC, CR, CH)
- ◆ Framatome Inc., (North American Headquarters), Lynchburg, VA (CS, FB, SR, SP)  
ISO-PACIFIC Remediation Technologies, Inc., Richland, WA (CO)  
Konecranes Nuclear Equipment & Services LLC, (Formerly Morris Material Handling / P&H), New Berlin, WI (CS, CO, CC, CR, CH, CX, CY, DG, E, FB, G, H, LM, MH, NS, RS, SR, SG, SF, ST, SU, SP, TB)

- Mitsubishi Nuclear Energy Systems, Inc., (A Sub. of Mitsubishi Heavy Industries, Ltd.), Charlotte, NC (CS, CO, CC, CR, CH, CX, DG, E, FB, G, H, LM, MH, NS, RS, SR, SG, SF, ST, SU, SP, TB)
- PAR Systems, LLC, Saint Paul, MN (CS, CO, CC, CR, CH, CX, CY, DG, E, FB, G, MH, RS, SR, SG, SF, ST, SU, SP, TB)
- PTP Spent Fuel Services, LLC, Grand Island, NY (SP)
- REEL COH Inc., Canada (CS, CO, CC, CR, CH, CX, DG, E, FB, G, H, LM, MH, RS, SG, SF, ST, SU, SP)
- Sarens Nuclear & Industrial Services LLC, (Sarens), Houston, TX (CR, CX, CY, G, SG)
- Schulz Electric, Timken Power Systems, East Haven, CT (CS, CO, CC, DG, E, G, H, LM, MH, NS, RS, SG, SF, ST, SU, SP)
- Toshiba America Energy Systems Corp., West Allis, WI (FB, SP)
- TW Metals - Nuclear Materials Solutions, Linden, MI (CC, CR, CH, CX)  
B. E. Wallace Products Corp., (dba Wallace Cranes), Malvern, PA (E, G, H, LM)  
Westinghouse Electric Co. LLC, Cranberry Township, PA (CS, FB, NS, SR, SP, TB)
- ◆ Westinghouse Electric Company LLC, (Westinghouse Parts Business), New Stanton, PA (CS, CC, CR, CH, CX, CY, E)

**19280 Cyber Security**

- Burns & McDonnell, Kansas City, MO  
Computer Engineering Services, Inc., Chattanooga, TN  
Concurrent Technologies Corporation, (Center for Advanced Nuclear Manufacturing), Johnstown, PA
- ◆ Element Nuclear (NTS Labs), (Nuclear Engineering & Test Services), Huntsville, AL
- ◆ EXCEL Services Corporation, Rockville, MD
- ◆ Framatome Inc., (North American Headquarters), Lynchburg, VA  
GEM Technologies, Inc., Knoxville, TN  
Kinectrics Inc., Toronto, Ontario, Canada

**WHAT'S THE VALUE OF REDUCING YOUR CRITICAL PATH?**

WATCH OUR VIDEO AND SEE HOW YOU CAN IMPROVE YOUR PLANT'S PERFORMANCE AND BOTTOM LINE.

**BARNHART**

Mirion Technologies (MGPI H&B) GmbH,  
(Mirion Technologies), Munich, Germany  
North Wind Group, Idaho Falls, ID  
Numerical Advisory Solutions, LLC, Cary, NC  
◆ Paragon Energy Solutions, (Paragon), Fort  
Worth, TX  
RKVST, Santa Clara, CA  
Southwest Research Institute, San Antonio, TX  
Theseus Quality Assurance, LLC, Richland, WA  
◆ Ultra Energy, (Weed Instrument), Round Rock,  
TX  
Westinghouse Electric Co. LLC, Cranberry  
Township, PA

### 19450 Dampers

AF Air-Flow Control  
B Backdraft  
F Fire  
HE High-Energy Line Break  
I Isolation  
IA Isolation, Bubble-tight  
T Tornado Protection  
V Volume  
Camfil USA, Inc., Washington, NC (I, IA)  
Carolina Fabricators, West Columbia, SC (AF, B,  
I, V)  
◆ Curtiss-Wright Nuclear Division, Brea, CA (AF,  
B, F, HE, I, IA, T, V)  
Curtiss-Wright Nuclear Division, QualTech NP,  
Cincinnati, OH (AF, B, F, HE, I, IA, T, V)  
Ellis & Watts Global Industries, Inc., (a sub. of  
Marmont, a Berkshire Hathaway company),  
Batavia, OH (AF, B, F, I, IA, T, V)  
Energy Steel, Rochester Hills, MI (AF, HE, V)  
IONEX Research Corp., Lafayette, CO (IA)  
◆ NUCON International, Inc., Columbus, OH (IA)  
◆ Paragon Energy Solutions, (Paragon), Fort  
Worth, TX (AF)  
Piping Technology & Products, Inc., Houston,  
TX (AF, B, F, HE, I, IA, T)  
PMT Nuclear, Woodridge, IL (AF, B, F, HE, I, IA,  
T, V)  
Radiation Protection Systems, (by Alpha  
Safety), Groton, CT (AF, I, IA)  
River Technologies, LLC, Forest, VA (AF)  
◆ SSM Industries, Inc., (Nuclear Div.), Pittsburgh,  
PA (AF, B, F, HE, I, IA, T, V)  
◆ Westinghouse Electric Company LLC,  
(Westinghouse Parts Business), New Stanton,  
PA (AF, B, F, HE, I, IA, T, V)

### 19700 Data Acquisition/Handling Systems

A Analog  
D Digital  
◆ AVANTech, LLC, Columbia, SC (A, D)  
CAEN SyS, (CAEN SpA), Viareggio, LU, Italy (D)  
◆ Curtiss-Wright Nuclear Division, Brea, CA (A,  
D)  
Curtiss-Wright Nuclear Division, Scientech,  
Idaho Falls, ID (A, D)  
◆ Element Nuclear (NTS Labs), (Nuclear  
Engineering & Test Services), Huntsville, AL  
(D)  
◆ Framatome Inc., (North American  
Headquarters), Lynchburg, VA (A, D)  
GE Hitachi Nuclear Energy, Wilmington, NC  
(D)  
General Atomics Electromagnetic Systems, San  
Diego, CA (A, D)  
Hoskin Scientific, Oakville, Ontario, Canada (A,  
D)  
Knowledge Relay, Cypress, CA (A, D)  
Mirion Technologies (Canberra) Inc., Meriden,  
CT (A, D)  
NuclearN, Phoenix, AZ (D)  
Numerical Advisory Solutions, LLC, Cary, NC  
(A, D)  
ORTEC, Oak Ridge, TN (D)  
◆ Paragon Energy Solutions, (Paragon), Fort  
Worth, TX (A)  
Radics LLC, Kropyvnytskyi, Ukraine (D)  
RKVST, Santa Clara, CA (D)  
Southwest Research Institute, San Antonio, TX  
(A, D)  
Toshiba America Energy Systems Corp., West  
Allis, WI (A, D)  
◆ Ultra Energy, (Weed Instrument), Round Rock,  
TX (A, D)

### 20000 Data Readout Devices, Terminals & Accessories

O Oscillographic  
PD Plotters, Digital  
PX Plotters, X-Y  
P Printers  
RC Recording Charts  
RP Recording Pens, Disposable  
SC Strip Chart Recorders  
V Video Display  
◆ Element Nuclear (NTS Labs), (Nuclear  
Engineering & Test Services), Huntsville, AL  
(V)  
GE Hitachi Nuclear Energy, Wilmington, NC (O,  
PD, PX)  
GLSEQ, LLC, Huntsville, AL (V)  
Mirion Technologies (Canberra) Inc., Meriden,  
CT (PD, P, V)

### 20250 Debris/Foreign Object Control

◆ Alphasource, Inc., Philadelphia, PA  
◆ American DND Inc., Grand Island, NY  
CS-2 Inc., Grand Island, NY  
◆ Dominion Engineering, Inc., Reston, VA  
Electrical Builders Inc. (EBI), St. Cloud, MN  
◆ Framatome Inc., (North American  
Headquarters), Lynchburg, VA  
◆ I.C.E. Service Group, Inc., Moon Township, PA  
PTP Spent Fuel Services, LLC, Grand Island, NY  
The Perma-Type Company, Inc., Plainville, CT

### 20300 Decommissioning Services

DC Decontamination  
DM Demolition  
DS Dismantling  
DU Dust Suppression  
E Engineering Support Services  
RS Radiological Surveys  
SS SAFSTOR  
TI Transportation, Intermodal  
TR Transportation, Rail  
3D PLUS, (Detection Systems), Versailles,  
France (RS)  
Accelerated Decommissioning Partners - ADP,  
Dallas, TX (DC, DM, DS, E, RS, TR)  
Advanced Consulting Group, Inc., Chicago, IL  
(DS, E)  
Advanced Technologies and Laboratories  
(ATL) International, Inc., (wholly owned  
sub. of Planned Systems International, Inc.),  
Gaithersburg, MD (DC, DM, RS)  
Advetage Solutions, El Segundo, CA (RS)  
Alaron Nuclear Services, (Veolia Nuclear  
Solutions Federal Services - Alaron),  
Wampum, PA (DC, TI, TR)  
American DND Engineering, PC, Ellicottville,  
NY (DM, E)  
◆ American DND Inc., Grand Island, NY (DC,  
DM, DS, E, TI, TR)  
*See advertisement on page 9*  
ANTECH Corp., Arvada, CO (RS)  
Argonne National Laboratory, (EOF Div.),  
Lemont, IL (E)  
ATS Industrial Automation, Inc. - Nuclear (UK),  
Blaby, Leicester, United Kingdom (E)  
ATS Industrial Automation, Inc. Nuclear  
(Canada), Cambridge, Ontario, Canada (E)  
◆ AVANTech, LLC, Columbia, SC (DC, E)  
Babcock Services, Inc., Kennewick, WA (DC,  
DM, DS, E, RS, SS)  
◆ Banda Group International, LLC, Mesa, AZ (DC,  
DM, E, RS)  
◆ Barnhart Nuclear Services, Fairhope, AL (DS,  
TI, TR)  
◆ Bechtel, (Bechtel Power), (Bechtel Nuclear,  
Security & Environmental), (Bechtel National),  
Reston, VA (DC, DS, E)  
Berthold Technologies USA LLC, Oak Ridge, TN  
(RS)  
Bevelacqua Resources, (Radiation Protection),  
Owens Cross Roads, AL (DC, E, RS)  
BHI Energy - now Westinghouse, See listing  
for Westinghouse Electric Co., Cranberry  
Township, PA (DC, DM, DS, E, RS)  
Bilfinger Noell GmbH, (Dept. BEV), Wuerzburg,  
Germany (DC, DS, E)  
Black & Veatch, Overland Park, KS (E)

Bluegrass Concrete Cutting, Inc., Greenville,  
AL (DC, DM, DS)  
◆ Boston Government Services, LLC (BGS), Oak  
Ridge, TN (E)  
Brandenburg Industrial Service Company,  
Bethlehem, PA (DC, DM, DS)  
◆ Brokk Inc., (Sub. of Brokk-Sweden), (Nuclear  
Div.), Santa Fe, NM (DS)  
Burns & McDonnell, Kansas City, MO (E, RS)  
BWX Technologies, Inc., Lynchburg, VA (DC,  
DM, DS)  
Cabrera Services Inc., East Hartford, CT (DC,  
DS, E, RS)  
Carignan & Associates LLC, Chattanooga, TN  
(E)  
Central Research Laboratories, Red Wing, MN  
(DC)  
Centronic Ltd., Surrey, United Kingdom (RS)  
Chesapeake Nuclear Services, Inc., Annapolis,  
MD (RS)  
Croft Associates Ltd, Abingdon, Oxfordshire,  
United Kingdom (E, TI, TR)  
CS-2 Inc., Grand Island, NY (DC, DM, DS, DU,  
E, TI, TR)  
Cutting Technologies (CTI), Gloucester City, NJ  
(DS)  
◆ Dominion Engineering, Inc., Reston, VA (DC, E)  
Dufrane Nuclear Shielding Inc., (Dufrane  
Nuclear Inc.), Winsted, CT (DC, DS, E, SS)  
DW James Consulting, LLC, North Oaks, MN  
(DC, E)  
E.H. Wachs, (A Div. of ITW), Lincolnshire, IL  
(DS)  
E.S. Fox Limited, Niagara Falls, Ontario,  
Canada (DC, DS, E, RS, SS)  
ECC, Burlingame, CA (DM, DS, E, RS, TI)  
Encorus Group, Springville, NY (DC, DM, DS)  
Energy Steel, Rochester Hills, MI (E)  
◆ EnergySolutions, Salt Lake City, UT (DC, DM,  
DS, E, RS, SS, TI, TR)

#### See advertisement on page 11

Environmental Restoration Group, Inc.,  
Albuquerque, NM (RS)  
◆ EXCEL Services Corporation, Rockville, MD (E)  
Fuel Tank Maintenance Co., LLC, Cookeville,  
TN (DC, DM, DS, E)  
GEM Technologies, Inc., Knoxville, TN (DC,  
DM, DS, DU, E)  
GNS Gesellschaft fur Nuklear-Service mbH,  
Essen, Germany (DC, DS)  
H3D, Inc., Ann Arbor, MI (RS)  
Hennigan Engineering LLC, Hingham, MA  
(DC)  
Hopewell Designs, Inc., Alpharetta, GA (DS)  
◆ I.C.E. Service Group, Inc., Moon Township, PA  
(E, TI, TR)  
Imperia Engineering Partners LLC, Milford,  
MA (E)  
In-Place Machining Company, LLC, Blue Ash,  
OH (DS)  
ISO-PACIFIC Remediation Technologies, Inc.,  
Richland, WA (DC)  
Jacobs, (CH2M HILL Nuclear Business Group),  
(CH2M HILL International Nuclear Services,  
Ltd.), (CH2M HILL Constructors, Inc.), (Jacobs  
Engineering), (Jacobs), Dallas, TX (DC, DS, E)  
James Fisher Technologies, Loveland, CO (DC,  
DM, DS, E, RS)  
Jensen Hughes, Baltimore, MD (E)  
KCI Engineering Consultants, Downers Grove,  
IL (E)  
Kinectrics Inc., Toronto, Ontario, Canada (DC,  
E, RS)  
LATA, Albuquerque, NM (DC, DM, DS, E)  
Longenecker & Associates, Inc., Las Vegas, NV  
(E)  
Manafort Brothers Inc., Plainville, CT (DC, DM)  
Mega-Tech Services, LLC, Cooksburg, PA (DC,  
DS, E)  
Meridian Services Group, (formerly Work  
Management, Inc.), Chattanooga, TN (E)  
Merrick & Company, Greenwood Village, CO (E)  
Mirion Technologies (Canberra) Inc., Meriden,  
CT (DC)  
◆ NAC International Inc., Peachtree Corners, GA  
(E, TI, TR)  
NAC LPT LLC, Mars, PA (TI, TR)  
NAC Philotechnics, Ltd., Oak Ridge, TN (DC,  
DM, DS, E, RS, SS, TI, TR)

# Over 40 Years of Nuclear HVAC Experience

SSM Industries has over 40 years experience designing, qualifying, fabricating and installing complete HVAC ductwork systems and equipment in DOE facilities and Nuclear Power Plants around the world.

Let us work with you on all of your HVAC needs. From custom retrofits to new plant build, we are the HVAC solution that you have been looking for.



## HVAC SYSTEM COMPONENTS

Access Doors  
Actuators: Electric & Pneumatic  
Air Handling Units  
Charcoal Adsorber Units  
Dampers:  
Backdraft  
Balancing  
Bubble-Tight  
Control: Manual, Electric & Pneumatic  
Diverter  
Fire & Smoke  
Guillotine  
HELB  
Isolation

## HVAC SYSTEM COMPONENTS

Tornado  
Variable Frequency Drives  
Ductwork & Supports  
Fans: Axial & Centrifugal  
Filters & Filtration Units (incl. HEPA)  
Flexible Connections  
Grilles, Registers & Diffusers  
Housings  
Heat Exchangers  
Cooling Coils  
Louvers  
Plenums  
Sleeves

## SPECIALTY FABRICATIONS

Angle Rings  
Cable Trays & Covers  
Control Cabinets  
Doors: Access, Heavy-Duty & Blast  
Equipment Bases  
Filter Boxes  
Fire Barriers  
U. L.-Rated, 3 Hour  
Glove Boxes  
Sealed Enclosures  
Seismic Supports  
Cooling Coils  
Heating Coils  
Heat Exchangers  
Tanks

## QUALITY CERTIFICATIONS

NQA-1  
ASME AG-1  
10CFR50  
Appendix B  
ASME  
AWS

For more information contact the SSM Power Division at (412) 777-5101 or visit us at [www.ssmi.biz](http://www.ssmi.biz) to learn how our experience can benefit your next project.



(412) 777-5101 • [ssmi.biz](http://ssmi.biz)

NAES Power Contractors, Inc., Shelocta, PA (DS)  
 Navarro, Oak Ridge, TN (DC, DS, E, RS)  
 NSSI/Recovery Services Inc., Houston, TX (DC, DS)  
 Nuclear-21, Waasmunster, Belgium (DC)  
 Numerical Advisory Solutions, LLC, Cary, NC (E)  
 Orano Decommissioning Services, Hudson, MA (DC, DM, DS, E, RS, TR)  
 Orano Federal Services, Charlotte, NC (DC, DM, DS, E, RS, SS, TI, TR)  
 Orano TN, Columbia, MD (TI, TR)  
 Orano USA, Bethesda, MD (DC, DS, E, RS, TI, TR)

◆ **PacTec, Inc., Clinton, LA (TI, TR)**

Pajarito Scientific Corp., Santa Fe, NM (DC, RS)  
 PAR Systems, LLC, Saint Paul, MN (E)  
 Paschal Solutions, Inc., Knoxville, TN (E)  
 Perma-Fix Environmental Services, Inc., Oak Ridge, TN (DM)  
 PHDS Co., Knoxville, TN (RS)  
 PROTEM USA LLC, Evergreen, CO (DS)  
 PTP Spent Fuel Services, LLC, Grand Island, NY (DC, DM, DS, DU, E, TI, TR)  
 Radiation Protection Systems, (by Alpha Safety), Groton, CT (E)

◆ **Radiation Safety & Control Services, Inc., Seabrook, NH (DC, DS, E, RS, SS)**

*See advertisement on cover 3*

Red Wolf Associates, Cary, NC (E)  
 ReNuke, Oak Ridge, TN (DC, DS, E, RS, SS)  
 Republic Services, Livonia, MI (DC)  
 Robatel Technologies, LLC, Roanoke, VA (DS, E)  
 Rogante Engineering Office, Civitanova Marche, Italy (E)  
 S&K Logistics Services, Byron, GA (E)  
 Sarens Nuclear & Industrial Services LLC, (Sarens), Houston, TX (DS, TI, TR)  
 Siempelkamp NIS, Alzenau, Germany (DC, DS, E)  
 Sigma Science, Inc., Albuquerque, NM (E, RS)

Sonic Systems International, LLC, Houston, TX (E)  
 Standish Technologies International, Export, PA (E)  
 ◆ Strategic Packaging Systems, (I.C.E. Packaging Company, LLC), Madisonville, TN (TI, TR)  
 Teledyne Brown Engineering, Inc., Huntsville, AL (DS, E)  
 TerranearPMC, LLC, Exton, PA (DC, DM, DS, E, RS)  
 Tetra Tech Inc., Richland, WA (DC, DM, DS, DU, E, RS)  
 The Delphi Groupe, Inc., Austin, TX (DC)  
 TLG Services, LLC, (sub. of Entergy Corp.), Bridgewater, CT (DC, DM, DS, E, RS, SS)  
 Toshiba America Energy Systems Corp., West Allis, WI (DC, DS, E, RS)  
 TSSD Services, Inc., Sidney, ME (E)  
 ◆ Underwater Construction Corp., (Underwater Construction Corp. UK Ltd.), Essex, CT (DC, DS)  
 ◆ UniTech Services Group, Inc., (Div. of UniFirst Corp.), Longmeadow, MA (DC, DS)  
 Veolia Nuclear Solutions - Federal Services, Piketon, OH (DC, DM, DS, E, RS, TI, TR)  
 Waste Control Specialists LLC, Andrews, TX (TI, TR)  
 Westinghouse Electric Co. LLC, Cranberry Township, PA (DC, DM, DS, E, RS, SS, TI, TR)  
 ◆ WMG, Inc., Peekskill, NY (DC, DS, E, RS)  
 Zachry Nuclear Engineering, Charlotte, NC (E)

HW High-Pressure Water  
 IB Ice Blasting (Wet Ice)  
 LD Laser Decontamination  
 PS Plugs & Seals  
 S Services  
 SW Soil Washing  
 SC Strippable Coatings  
 UW Ultra-High-Pressure Water  
 U Ultrasonics  
 VB Vacuum Blasting, Abrasive  
 VF Vibratory Finishing

Advetage Solutions, El Segundo, CA (CD)  
 Alaron Nuclear Services, (Veolia Nuclear Solutions Federal Services - Alaron), Wampum, PA (CD, S)  
 ◆ American DND Inc., Grand Island, NY (CS, HS, S, UW)

Arkema, Inc., (formerly ATOFINA Chemicals, Inc.), King of Prussia, PA (C)  
 Babcock Services, Inc., Kennewick, WA (AC, CD, C, CS, CR, E, HS, HW, IB, LD, S, UW)  
 BHI Energy - now Westinghouse, See listing for Westinghouse Electric Co., Cranberry Township, PA (AC, CD, CS, D, E, HS, HW, S, SC, UW, VB)

Bilfinger Noell GmbH, (Dept. BEV), Wuerzburg, Germany (CD, EP)

◆ Brokk Inc., (Sub. of Brokk-Sweden), (Nuclear Div.), Santa Fe, NM (CS)

BWX Technologies, Inc., Lynchburg, VA (S)  
 Coastal Network, Inc, Charlottesville, VA (C, SC)

Desco Mfg. Co., Inc., Rancho Santa Margarita, CA (AC, CS, E, HS)

◆ Dominion Engineering, Inc., Reston, VA (CD, U)  
 Electrical Builders Inc. (EBI), St. Cloud, MN (CR, EP, S)

◆ EnergySolutions, Salt Lake City, UT (AC, CD, CS, HW, S, SW, UW, VB)

FEVDI Nuclear Decontamination, Corbas, France (CD, C, SC)

## 20350 Decontamination Chemicals, Equipment & Services

AC Abrasive Cleaning  
 CD Chemical Decontamination  
 C Chemicals  
 CS Concrete Scabbling  
 CR Cryogenic Cleaning (CO2)  
 D Drainline  
 EP Electropolishing  
 E Equipment  
 HS Hand Scrubbing  
 HF High-Pressure Freon

# The industry leader for all of your Low Level Waste Packaging needs

Macroencapsulation Bags For LLMW & RLS | IP-1, IP-2 & Type A LiftPacs



IP-1 & IP-2 Drum Overpacs | IP-1 RailPac | LiftPac Self Standing Series (SS & SSX)



ASK ABOUT OUR PATENTED IP-1 & IP-2 FLEXIBLE PACKAGING

**PACTEC**  
 We manufacture packaging. We engineer solutions.

(800) 272-2832 [pactecinc.com](http://pactecinc.com)



◆ Denotes advertiser—see Index to Advertisers on pages 8–14

- ◆ Framatome Inc., (North American Headquarters), Lynchburg, VA (AC, CD, HS, HW, S, SC, UW, VB)
- Fuel Tank Maintenance Co., LLC, Cookeville, TN (AC, CD, C, CS, CR, HS, HW, S, SC, UW)
- GE Hitachi Nuclear Energy, Wilmington, NC (S)
- GEM Technologies, Inc., Knoxville, TN (CD, C, CS, HW)
- GNS Gesellschaft fur Nuklear-Service mbH, Essen, Germany (CD, E, S)
- Heat Exchanger Products Corp. (HEPCO), Hingham, MA (PS)
- Hennigan Engineering LLC, Hingham, MA (HW, UW)
- James Fisher Technologies, Loveland, CO (AC, CS, E, HW, VB)
- JETSEAL, Inc., Spokane Valley, WA (PS)
- Kinetrics Inc., Toronto, Ontario, Canada (CD, C, S)
- M2 Polymer Technologies, Inc., West Dundee, IL (C)
- Marshallton Research Laboratories, Inc., King, NC (C)
- Mega-Tech Services, LLC, Cooksburg, PA (E)
- Mirion Technologies (Canberra) Inc., Meriden, CT (S)
- NAC Philotechnics, Ltd., Oak Ridge, TN (S)
- New Millennium Nuclear Technologies International, Lakewood, CO (CS)
- North Wind Group, Idaho Falls, ID (CD)
- NSSI/Recovery Services Inc., Houston, TX (CD, S)
- Nuclear-2I, Waasmunster, Belgium (AC, CD, CR, EP, E, LD, S, U)
- Orano USA, Bethesda, MD (S)
- PAR Systems, LLC, Saint Paul, MN (E, HW, LD, UW)
- Perma-Fix Environmental Services, Inc., Oak Ridge, TN (S, SW)
- ◆ Preferred Engineering Corp., (Sub. of Preferred Utilities Mfg. Corp.), Danbury, CT (PS)
- Radiological Solutions Inc., Rockdale, IL (EP)
- Republic Services, Livonia, MI (CD, UW, VB)

- Rexon Components, Inc., Beachwood, OH (C)
- River Technologies, LLC, Forest, VA (E, HW, VB)
- Schulz Electric, Timken Power Systems, East Haven, CT (CR, HW, S)
- Scientific Sales, Inc., Oak Ridge, TN (AC, CD, C, E)
- ◆ Strategic Packaging Systems, (I.C.E. Packaging Company, LLC), Madisonville, TN (S)
- Tetra Tech Inc., Richland, WA (AC, CD, CS, E, S)
- The Delphi Groupe, Inc., Austin, TX (S)
- Toshiba America Energy Systems Corp., West Allis, WI (CD, CS, CR)
- UniTech Services Group Europe, (Sub. of UniTech Services Group USA), Coevorden, Netherlands (The) (CD, SC, U)
- ◆ UniTech Services Group, Inc., (Div. of UniFirst Corp.), Longmeadow, MA (AC, CR, E, HS, HW, S, VB)
- Veolia Nuclear Solutions - Federal Services, Piketon, OH (CD, HW, LD)
- ◆ Wagstaff Applied Technologies, Spokane, WA (CR)
- Westinghouse Electric Co. LLC, Cranberry Township, PA (AC, CD, C, CS, D, E, HS, HW, S, SC, UW, U, VB)
- ◆ WMG, Inc., Peekskill, NY (S)

**20500 Degasifiers**

- Joseph Oat Corp., Camden, NJ
- Pylon Electronics Inc., (Instrument Manufacturing Div.), Ottawa, Ontario, Canada

**20700 Demolition & Dismantlement**

- American DND Engineering, PC, Ellicottville, NY
- ◆ American DND Inc., Grand Island, NY
- Babcock Services, Inc., Kennewick, WA
- Bluegrass Concrete Cutting, Inc., Greenville, AL
- Brandenburg Industrial Service Company, Bethlehem, PA
- BWX Technologies, Inc., Lynchburg, VA
- Campoverde srl, Milano, Italy

- CS-2 Inc., Grand Island, NY
- GEM Technologies, Inc., Knoxville, TN
- In-Place Machining Company, LLC, Blue Ash, OH
- Jacobs, (CH2M HILL Nuclear Business Group), (CH2M HILL International Nuclear Services, Ltd.), (CH2M HILL Constructors, Inc.), (Jacobs Engineering), (Jacobs), Dallas, TX
- James Fisher Technologies, Loveland, CO
- LATA, Albuquerque, NM
- Manafort Brothers Inc., Plainville, CT
- PAR Systems, LLC, Saint Paul, MN
- Perma-Fix Environmental Services, Inc., Oak Ridge, TN
- PTP Spent Fuel Services, LLC, Grand Island, NY
- Republic Services, Livonia, MI
- Siempelkamp NIS, Alzenau, Germany
- Veolia Nuclear Solutions - Federal Services, Piketon, OH

**21200 Desuperheaters**

- Joseph Oat Corp., Camden, NJ
- ◆ Schutte and Koerting, Treviso, PA
- ◆ Thermal Engineering International (TEI), Cerritos, CA

**21270 Detector Heads, Sold Separately**

- BF BF3 Neutron Counters
- GM Geiger-Mueller Tubes/Probes
- HN He3 Neutron Counters
- IC Ionization Chambers
- PM Photomultiplier Tubes
- PC Proportional Counters
- SP Self-Powered Type
- SL Scintillation Counters, Liquid
- ST Scintillation Counters, Solid-State
- SS Solid-State Semiconductor Type
- Berthold Technologies USA LLC, Oak Ridge, TN (GM, HN, IC, PM, PC)
- Centronic Ltd., Surrey, United Kingdom (BF, GM, HN, IC, PC, SS)
- DETEK, Temple Hills, MD (GM, IC)

**Kiewit**

**JOBS DONE WELL**

Backed by 140 years of experience, Kiewit's nuclear history began in 1952 with the Portsmouth Gaseous Diffusion Plant. Today, we have a diverse array of experience as an NQA-1, ASME Section III and N-Stamp quality provider, and are dedicated to being a premier contractor in the nuclear market. Kiewit's nuclear-grade quality programs are staffed by engineering, procurement and construction experts. Our integrated team incorporates constructability into the earliest stages of project development for schedule and cost certainty.

SCAN TO LEARN MORE ABOUT OUR NUCLEAR CAPABILITIES

**KIEWIT.COM**

ENVINET GmbH, Munich/Haar, Germany (GM, PC, SP, ST)  
GE Hitachi Nuclear Energy, Wilmington, NC (HN, IC, PC)  
Health Physics Instruments, (Div. of Far West Technology), Goleta, CA (BF, GM, HN, IC)

- ◆HI-Q Environmental Products Co., Inc., San Diego, CA (GM, IC, PM, ST, SS)
- ◆LND, Inc., Oceanside, NY (BF, GM, HN, IC, PC, SL, ST)
- Ludlum Measurements, Inc., Sweetwater, TX (ST)
- Mirion Technologies (Canberra) Inc., Meriden, CT (BF, GM, HN, PC, ST, SS)
- Mirion Technologies (IST Canada) ULC, (Formerly Mirion Technologies (IST Canada) Inc.), Cambridge, Ontario, Canada (BF, IC, PC, SP)
- ◆Mirion Technologies (IST) Corp., (Sensing Systems Div.), Horseheads, NY (BF, IC, PC, SP)
- Mirion Technologies (MGPI H&B) GmbH, (Mirion Technologies), Munich, Germany (BF, GM, HN, IC, PC, SP, ST)
- Mirion Technologies (Premium Analyse) SAS, Norroy Le Veneur, France (IC)
- Mirion Technologies, Inc., (Sensing Systems Div.), Atlanta, GA (BF, GM, IC, PC, SP)
- ORTEC, Oak Ridge, TN (PM, ST, SS)
- Overhoff Technology Corp., (A Div. of US Nuclear Corp.), Milford, OH (IC)
- ◆Paragon Energy Solutions, (Paragon), Fort Worth, TX (BF, IC, PC)
- PHDS Co., Knoxville, TN (SS)
- ◆Photonis, Brive la Gaillarde Cedex, France (IC, PC)
- Pylon Electronics Inc., (Instrument Manufacturing Div.), Ottawa, Ontario, Canada (PM, ST)
- ◆Radiation Safety & Control Services, Inc., Seabrook, NH (BF, GM, HN, IC, PM, PC, SP, SL, ST, SS)
- Rexon Components, Inc., Beachwood, OH (GM, IC, PM, PC, SL, ST)
- Technology for Energy Corp., Knoxville, TN (PC)
- ◆Thermo Scientific - CIDTEC Cameras & Imagers, (Part of Thermo Fisher Scientific), Liverpool, NY (SS)
- THERMOCOAX Inc., Alpharetta, GA (SP)
- THERMOCOAX SAS, Caligny, France (SP)
- Toshiba America Energy Systems Corp., West Allis, WI (HN, IC, PC, ST, SS)
- Tyne USA Inc., Jacksonville, FL (BF, IC)
- US Nuclear Corp., (Technical Associates Sub.), (Overhoff Technology Corp. Sub.), Canoga Park, CA (BF, GM, HN, IC, PM, PC, SP, SL, ST, SS)

### 21300 Detectors, Accelerator Beam

Berthold Technologies USA LLC, Oak Ridge, TN  
Centronic Ltd., Surrey, United Kingdom  
Mirion Technologies, Inc., (Sensing Systems Div.), Atlanta, GA  
US Nuclear Corp., (Technical Associates Sub.), (Overhoff Technology Corp. Sub.), Canoga Park, CA

### 21310 Detectors, Aerosol/Particulate

Berthold Technologies USA LLC, Oak Ridge, TN  
Centronic Ltd., Surrey, United Kingdom  
ENVINET GmbH, Munich/Haar, Germany  
Mirion Technologies (Canberra) Inc., Meriden, CT  
Mirion Technologies (MGPI H&B) GmbH, (Mirion Technologies), Munich, Germany  
Mirion Technologies, Inc., (Sensing Systems Div.), Atlanta, GA  
◆NUCON International, Inc., Columbus, OH

### 21320 Detectors, Air Bubble (In Liquid)

- ◆Framatome Inc., (North American Headquarters), Lynchburg, VA

### 21370 Detectors, Explosives

H Hand-Held  
W Walk-Through  
GLSEQ, LLC, Huntsville, AL (H)

ISO-PACIFIC Remediation Technologies, Inc., Richland, WA (H)  
NETCo, Windsor, ME (H, W)

### 21400 Detectors, Leak

A Acoustic  
B Bubble Test  
EC Electron Capture (SF/6)  
G Gas  
HE HEPA Filter  
IL Integrated Leak Rate Testing  
MS Mass Spectrometer (He)  
PC Pressure Change  
ASI Marine, (ASI Group Ltd.), Orchard Park, NY (G, PC)  
Camfil USA, Inc., Washington, NC (HE)  
Centronic Ltd., Surrey, United Kingdom (MS)  
Croft Associates Ltd, Abingdon, Oxfordshire, United Kingdom (B, G, IL, MS)  
◆Curtiss-Wright Nuclear Division, Brea, CA (HE)  
Curtiss-Wright Nuclear Division, QualTech NP, Cincinnati, OH (HE)  
◆Framatome Inc., (North American Headquarters), Lynchburg, VA (A, G, IL, MS, PC)  
GE Hitachi Nuclear Energy, Wilmington, NC (A, B, EC, G, MS, PC)  
◆NUCON International, Inc., Columbus, OH (G, HE, PC)  
Pajarito Scientific Corp., Santa Fe, NM (HE)  
Scientific Sales, Inc., Oak Ridge, TN (G)  
Tyne USA Inc., Jacksonville, FL (B, EC, G)

### 21500 Detectors, Metal

NETCo, Windsor, ME  
SecurMAR, LLC, Zionsville, IN  
THERMOCOAX Inc., Alpharetta, GA  
THERMOCOAX SAS, Caligny, France

### 22150 Detectors, Resistance Temperature

- ◆Framatome Inc., (North American Headquarters), Lynchburg, VA
- Kanata Electronic Services Ltd., (Div. of Shawcor Ltd.), Toronto, Ontario, Canada
- Mirion Technologies (IST Canada) ULC, (Formerly Mirion Technologies (IST Canada) Inc.), Cambridge, Ontario, Canada
- ◆Mirion Technologies (IST) Corp., (Sensing Systems Div.), Horseheads, NY
- Mirion Technologies, Inc., (Sensing Systems Div.), Atlanta, GA
- ◆Paragon Energy Solutions, (Paragon), Fort Worth, TX
- ◆RdF Corporation, Hudson, NH
- Temp-Pro Inc., Northampton, MA
- THERMOCOAX Inc., Alpharetta, GA
- THERMOCOAX SAS, Caligny, France
- ◆Ultra Energy, (Weed Instrument), Round Rock, TX
- Westinghouse Electric Co. LLC, Cranberry Township, PA

### 22200 Detectors, Valve Position

- ◆Curtiss-Wright Nuclear Division, Brea, CA
- Curtiss-Wright Nuclear Division, QualTech NP, Cincinnati, OH
- ◆Paragon Energy Solutions, (Paragon), Fort Worth, TX
- Technology for Energy Corp., Knoxville, TN
- Westinghouse Electric Co. LLC, Cranberry Township, PA

### 22410 Dewatering Systems & Supplies

- ◆AVANTech, LLC, Columbia, SC
- Babcock Services, Inc., Kennewick, WA
- ◆EnergySolutions, Salt Lake City, UT
- ◆Framatome Inc., (North American Headquarters), Lynchburg, VA
- GNS Gesellschaft fur Nuklear-Service mbH, Essen, Germany
- Komline, Peapack, NJ
- Mitsubishi Nuclear Energy Systems, Inc., (A Sub. of Mitsubishi Heavy Industries, Ltd.), Charlotte, NC
- North Wind Group, Idaho Falls, ID
- ◆PacTec, Inc., Clinton, LA

- ◆Radiation Safety & Control Services, Inc., Seabrook, NH
- Westinghouse Electric Co. LLC, Cranberry Township, PA

### 22430 Diaphragms, Storage Tank

Corrosion Control Services, Inc., Davenport, IA  
Fuel Tank Maintenance Co., LLC, Cookeville, TN  
◆Westinghouse Electric Company LLC, (Westinghouse Parts Business), New Stanton, PA

### 22660 Display Systems, Annunciators

- ◆Curtiss-Wright Nuclear Division, Brea, CA
- Curtiss-Wright Nuclear Division, QualTech NP, Cincinnati, OH
- GE Hitachi Nuclear Energy, Wilmington, NC
- ◆Paragon Energy Solutions, (Paragon), Fort Worth, TX
- Radium Inc., Waynesboro, VA
- Westinghouse Electric Co. LLC, Cranberry Township, PA
- ◆Westinghouse Electric Company LLC, (Westinghouse Parts Business), New Stanton, PA
- WOORI Technology Inc., Seoul, Korea (The Republic of)

### 22700 Diving Services

- CB Cutting/Burning
- D Decontamination
- EI Equipment Installation/Realignment
- G Grouting
- I Inspection
- M Maintenance
- MJ Metals Joining (Other Than Welding)
- WD Welding, Dry Box
- WW Welding, Wet
- AECON-WACHS, (U.S. Div. of Aecon Nuclear), Jackson, SC (CB, D, EI, G, I, M, MJ, WD, WW)
- ASI Marine, (ASI Group Ltd.), Orchard Park, NY (CB, D, EI, G, I, M, MJ, WD, WW)
- ◆AVANTech, LLC, Columbia, SC (D)
- Constellation ClearSight, De Pere, WI (I)
- Cutting Technologies (CTI), Gloucester City, NJ (CB, G)
- GNS Gesellschaft fur Nuklear-Service mbH, Essen, Germany (CB, D, EI, G)
- ISO-PACIFIC Remediation Technologies, Inc., Richland, WA (D)
- PROTEM USA LLC, Evergreen, CO (CB, M, WD)
- ◆Underwater Construction Corp., (Underwater Construction Corp. UK Ltd.), Essex, CT (CB, D, EI, G, I, M, MJ, WD, WW)

See advertisement on page 15

### 22800 Doors

- AL Airlocks
- AA Airtight Access
- BL Blast
- BU Bullet-Resistant
- F Fireproof
- PR Pressure-Resistant
- RS Radiation-Shielded
- S Security
- SG Steam Generator Manway, Shielded
- TM Tornado/Missile-Resistant
- W Watertight
- Advanced Nuclear LLC, Aston, PA (F, RS)
- AECON-WACHS, (U.S. Div. of Aecon Nuclear), Jackson, SC (TM)
- Bilfinger Noell GmbH, (Dept. BEV), Wuerzburg, Germany (AL)
- Carolina Fabricators, West Columbia, SC (AL, AA, BL, PR, SG, TM, W)
- Consolidated Power Supply, (Div. of Consolidated Pipe & Supply Co., Inc.), Birmingham, AL (AA)
- ◆Curtiss-Wright Nuclear Division, Brea, CA (AL, AA, BL, BU, F, PR, RS, S, TM, W)
- Curtiss-Wright Nuclear Division, QualTech NP, Cincinnati, OH (AL, AA, BL, BU, F, PR, RS, S, TM, W)
- Ellis & Watts Global Industries, Inc., (a sub. of Marmon\*, a Berkshire Hathaway company), Batavia, OH (BL, BU, PR, RS, TM)

◆ Denotes advertiser—see Index to Advertisers on pages 8–14

- Energy Steel, Rochester Hills, MI (AL, AA, BU, F, SG, W)
- GE Hitachi Nuclear Energy, Wilmington, NC (SG)
- Hot Cell Services Corp., (HCS Corp.), Kent, WA (RS)
- Joseph Oat Corp., Camden, NJ (TM)
- MarShield Radiation Shielding, (Div. of Marswell Metal Industries Ltd.), Burlington, Ontario, Canada (RS)
- Merrick & Company, Greenwood Village, CO (AL, AA, RS)
- Newton Security Inc., Renton, WA (AL)
- Nuclear Shielding Supplies & Service, Tucson, AZ (RS)
- NuSource LLC, Alexandria, VA (F, TM, W)
- Pajarito Scientific Corp., Santa Fe, NM (AL, RS)
- PAR Systems, LLC, Saint Paul, MN (F)
- ◆ Paragon Energy Solutions, (Paragon), Fort Worth, TX (AL, AA, BL, BU, F, PR, RS, SG, TM, W)
- Paxton & Vierling Steel, Carter Lake, IA (RS)
- ◆ Petersen Inc. (A Precinmac Company), Ogden, UT (BU, RS)
- PMT Nuclear, Woodridge, IL (AA, BL, BU, F, PR, RS, S, TM, W)
- Premier Technology, Inc., Blackfoot, ID (AL, AA, BL, RS)
- ◆ Presray Corp., (Div. of Pawling Corp.) (Critical Containment Solutions), Wassaic, NY (AL, AA, BL, BU, F, PR, S, W)
- Radiation Protection Systems, (by Alpha Safety), Groton, CT (AL, RS)
- Robatel Technologies, LLC, Roanoke, VA (AL, AA, RS)
- SecurMAR, LLC, Zionsville, IN (BL, BU, S)
- ◆ Westinghouse Electric Company LLC, (Westinghouse Parts Business), New Stanton, PA (AL, AA, BL, BU, F, PR, RS, S, SG, TM, W)

**23850 Drafting Services**

- CM Computerized
- CN Conventional

- Black & Veatch, Overland Park, KS (CM)
- Consolidated Power Supply, (Div. of Consolidated Pipe & Supply Co., Inc.), Birmingham, AL (CM, CN)
- ◆ Curtiss-Wright Nuclear Division, Brea, CA (CM, CN)
- Curtiss-Wright Nuclear Division, Scientech, Idaho Falls, ID (CM, CN)
- EmmEn Marketing Consultants, Pune, Maharashtra, India (CM)
- GE Hitachi Nuclear Energy, Wilmington, NC (CM, CN)
- KCI Engineering Consultants, Downers Grove, IL (CM, CN)
- Merrick & Company, Greenwood Village, CO (CM)
- Numerical Advisory Solutions, LLC, Cary, NC (CM, CN)
- PAR Systems, LLC, Saint Paul, MN (CM)
- PMT Nuclear, Woodridge, IL (CM, CN)
- Premier Technology, Inc., Blackfoot, ID (CM)
- Radiation Protection Systems, (by Alpha Safety), Groton, CT (CM)
- ◆ Radiation Safety & Control Services, Inc., Seabrook, NH (CM)
- ◆ System One, Pittsburgh, PA (CM, CN)
- Toshiba America Energy Systems Corp., West Allis, WI (CM, CN)

**23900 Drains & Accessories**

- F Floor
- CP Floor Drain Cover Plates
- CW Floor Drain I.D./Warning Plates
- LD Leak Detector
- Coastal Network, Inc, Charlottesville, VA (CP, CW)
- Consolidated Power Supply, (Div. of Consolidated Pipe & Supply Co., Inc.), Birmingham, AL (F, CP)
- FCI-Fluid Components International, San Marcos, CA (LD)
- JSM Protective, Inc., Port St. Lucie, FL (CP, CW)

- ◆ Westinghouse Electric Company LLC, (Westinghouse Parts Business), New Stanton, PA (F, CP, CW, LD)
- 24000 Drives, Variable-Speed**
- ◆ Framatome Inc., (North American Headquarters), Lynchburg, VA
  - GE Hitachi Nuclear Energy, Wilmington, NC
  - ◆ Paragon Energy Solutions, (Paragon), Fort Worth, TX
  - PMT Nuclear, Woodridge, IL
  - PROTEM USA LLC, Evergreen, CO
  - Schulz Electric, Timken Power Systems, East Haven, CT
  - SERCO USA, Evergreen, CO
  - ◆ SSM Industries, Inc., (Nuclear Div.), Pittsburgh, PA
  - Toshiba America Energy Systems Corp., West Allis, WI
  - ◆ Westinghouse Electric Company LLC, (Westinghouse Parts Business), New Stanton, PA

**24080 Drum Locking Devices**

- ◆ Frham Safety Products, Inc., Rock Hill, SC

**24170 Dryers, Wet Solids**

- ◆ AVANTech, LLC, Columbia, SC
- Carolina Fabricators, West Columbia, SC
- Komline, Peapack, NJ
- Rousselet-Robatel, Pittsfield, MA

**24180 Duct, Cable Bus**

- AECON-WACHS, (U.S. Div. of Aecon Nuclear), Jackson, SC
- Electrical Builders Inc. (EBI), St. Cloud, MN
- ◆ Paragon Energy Solutions, (Paragon), Fort Worth, TX
- ◆ Westinghouse Electric Company LLC, (Westinghouse Parts Business), New Stanton, PA

# PRESRAY

## CRITICAL CONTAINMENT SOLUTIONS

845.373.6700

[www.presray.com/nuclear](http://www.presray.com/nuclear)



Is your facility compliant with NRC water-control regulations?

- ▶ Flood Protection Doors & Barriers
- ▶ Watertight Doors & Hatches
- ▶ Spent Fuel Pool Gates
- ▶ Specialty Doors: Fire-Rated, Airtight & Ballistic
- ▶ NUPIC Approved to 10CFR50 Appendix B

For over fifty years, Presray's innovative doors, windows and barriers have been used to protect vital buildings and facilities across America. With our experience, and broad product offering, we can help you meet the evolving needs of the nuclear industry.



## 24190 Duct, Wiring, Plastic

◆ Westinghouse Electric Company LLC, (Westinghouse Parts Business), New Stanton, PA

## 24250 Eductors, Containment Spray

◆ Schutte and Koerting, Trevese, PA

## 24270 Ejectors

descote, Feyzin, France  
 ◆ Schutte and Koerting, Trevese, PA

## 24300 Electrical Distribution & Control Equipment

BE Circuit Breakers, Enclosed  
 BM Circuit Breakers, Molded Case  
 BP Circuit Breakers, Power  
 BS Circuit Breakers, SF6 Gas  
 C Contactors  
 MC Motor Control Centers  
 P Panelboards  
 R Relays  
 S Starters  
 SS Substations, Metal-Enclosed  
 SB Switchboards (Power Distribution)  
 TV Transient Voltage Surge Suppression Systems

Basic E, Inc., Charlotte, VT (BE, BM, BP, BS, C, R, S, TV)  
 CBS Nuclear Services, Inc., Matthews, NC (R, S)  
 ◆ Curtiss-Wright Nuclear Division, Brea, CA (BE, BM, BP, BS, C, MC, P, R, S, SS, SB)  
 Curtiss-Wright Nuclear Division, QualTech NP, Cincinnati, OH (BE, BM, BP, BS, C, MC, P, R, S, SS, SB)  
 Curtiss-Wright Nuclear Division, Scientech, Idaho Falls, ID (BP, MC, P, R, S, SB)  
 E.S. Fox Limited, Niagara Falls, Ontario, Canada (BP)  
 Electrical Builders Inc. (EBI), St. Cloud, MN (SS)

◆ Element Nuclear (NTS Labs), (Nuclear Engineering & Test Services), Huntsville, AL (BE, BM, BP, BS, P, R)  
 ◆ Framatome Inc., (North American Headquarters), Lynchburg, VA (BE, BM, BP, BS, C, MC, P, R, S, SS, SB, TV)  
 GLSEQ, LLC, Huntsville, AL (BE, BP, SB, TV)  
 GUTOR, Houston, TX (P, SB)  
 Incap Electronics US, Inc., California, PA (P)  
 JNT Technical Services Inc., Little Ferry, NJ (SB)  
 Kinectrics Inc., Toronto, Ontario, Canada (R)  
 MillenniTEK, LLC, Knoxville, TN (MC)  
 Mirion Technologies (MGPI H&B) GmbH, (Mirion Technologies), Munich, Germany (MC)  
 NuSource LLC, Alexandria, VA (BM, C, MC, P, R)  
 ◆ Paragon Energy Solutions, (Paragon), Fort Worth, TX (BE, BM, BP, BS, C, MC, P, R, S, SB)  
*See advertisement on cover 4*  
 ◆ The Park Company, Pasco, WA (BM, BP, MC, R)  
 PMT Nuclear, Woodridge, IL (C, MC, P, R, S)  
 Radics LLC, Kropyvnytskyi, Ukraine (SB)  
 Schulz Electric, Timken Power Systems, East Haven, CT (C, MC, P, S)  
 Struthers-Dunn, LLC, Timmonsville, SC (BM, BP, C, R)  
 Temp-Pro Inc., Northampton, MA (P)  
 Toshiba America Energy Systems Corp., West Allis, WI (BE, BP, BS)  
 Westinghouse Electric Co. LLC, Cranberry Township, PA (BE, BM, BP, C, MC, P, R, S, SS, SB, TV)  
 ◆ Westinghouse Electric Company LLC, (Westinghouse Parts Business), New Stanton, PA (BE, BM, BP, BS, C, MC, P, R, S, SS, SB, TV)  
*See advertisement on cover 2*

## 24400 Electrometers

◆ Bot Engineering Ltd, Campbellville, Ontario, Canada  
 Centronic Ltd., Surrey, United Kingdom

Blue text indicates an advertiser within the category

Overhoff Technology Corp., (A Div. of US Nuclear Corp.), Milford, OH  
 ◆ Radiation Safety & Control Services, Inc., Seabrook, NH  
 US Nuclear Corp., (Technical Associates Sub.), (Overhoff Technology Corp. Sub.), Canoga Park, CA  
 ◆ Westinghouse Electric Company LLC, (Westinghouse Parts Business), New Stanton, PA

## 25000 Electronic Instrumentation & Supplies

Aurum Technologies, Blackfoot, ID  
 Automation Products, Inc., (Dynatrol Div.), Houston, TX  
 ◆ Bot Engineering Ltd, Campbellville, Ontario, Canada  
 Centronic Ltd., Surrey, United Kingdom  
 ◆ Curtiss-Wright Nuclear Division, Brea, CA  
 Curtiss-Wright Nuclear Division, QualTech NP, Cincinnati, OH  
 FCI-Fluid Components International, San Marcos, CA  
 ◆ Framatome Inc., (North American Headquarters), Lynchburg, VA  
 GE Hitachi Nuclear Energy, Wilmington, NC  
 General Atomics Electromagnetic Systems, San Diego, CA  
 ◆ LND, Inc., Oceanside, NY  
 Mirion Technologies (Canberra) Inc., Meriden, CT  
 ◆ Mirion Technologies (IST) Corp., (Sensing Systems Div.), Horseheads, NY  
 Mirion Technologies, Inc., (Sensing Systems Div.), Atlanta, GA  
 ◆ NUCON International, Inc., Columbus, OH  
 ORTEC, Oak Ridge, TN  
 ◆ OTEK Corp., Tucson, AZ  
 ◆ Paragon Energy Solutions, (Paragon), Fort Worth, TX  
 Pyragon Electronic Instrumentation, Rochester, NY

# OTTEK CORP. DIGITIZE I&C & SIMULATOR IN ONE OUTAGE

## EVOLVE OR PERISH

**No more "stuck" needles!**

**CONTACT US:**  
 sales@otekcorp.com  
 (520) 748 7900  
 Cage Code 57861

Proudly made in USA  
 Since 1974

**NOTHING TO CHANGE BUT THE ANALOGS!**  
**HIGHER EFFICIENCY = HIGHER PROFITS**  
 "ONE FOR ALL" & "ALL FOR ONE" ADAPTER PLATES, METERS & XMTRS  
 ELIMINATES 95% OF SPARES INVENTORY  
 REF. EPRI# 3002020578 & INL# 3002020579

www.otekcorp.com



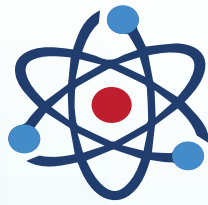

# Park Nuclear

POWER GENERATION SOLUTIONS

## ELECTRICAL

- Circuit Boards -
- Circuit Breakers -
  - Motors -
- Power Supplies -
  - Relays -
- Starters/Contactors -
  - Switches -
  - Transformers -

## OBSOLETE PART SOLUTIONS

- Largest Surplus Parts Inventory -
- Obsolescence Program Management -
  - Expedited Shipping -
  - Equivalency Evaluations -
- Inventory Marketing Program -
- Strategic Alternate Sourcing -
- Back Log Reduction Solutions -

## INSTRUMENTATION & CONTROL

- Annunciator Panels -
  - Controllers -
  - Flow Meters -
    - Gauges -
    - Meters -
  - Positioners -
  - Recorders -
- Radiation Monitoring -
- Seismic Monitoring -
  - Transmitters -

## REPAIR & TESTING SERVICES

- Expedited Repairs -
- Quick 3-5 Day Turnaround -
  - 100 Hour Burn-In -
  - On-Site Testing -
  - Shelf Life Renewal -
- Failure Analysis Reports -
  - Test Plan Setup -
- Parts Quality Program Management -
  - Battery Replacement -

## MECHANICAL

- Actuators -
- Compressors -
- Fans (Axial & Centrifugal) -
  - Gear Drives -
- Heat Exchangers -
  - Hydraulics -
- Pumps & Pump Parts -
  - Strainers -
- Turbines & Turbine Parts -
  - Valves & Valve Parts -

## REVERSE ENGINEERING

- Circuit Boards -
- Power Supplies -
  - Valves -
- Direct Replacements -
- Expedited Project Development -
- Functional Analysis & Testing -
  - 3-D Scanning -
  - Retrofitting -
- Schematic Design Document Support -

509-547-9929

[obsolete@parknuclear.com](mailto:obsolete@parknuclear.com)

[www.parknuclear.com](http://www.parknuclear.com)



Search our Inventory Online

Rosemount Nuclear Instruments, Inc.,  
Chanhasen, MN  
SOR Inc., Lenexa, KS  
Temp-Pro Inc., Northampton, MA  
Westinghouse Electric Co. LLC, Cranberry  
Township, PA  
◆ Westinghouse Electric Company LLC,  
(Westinghouse Parts Business), New Stanton,  
PA

## 25250 Emergency Response Equipment

RD Radiation Detection/Survey Meters  
3D PLUS, (Detection Systems), Versailles,  
France (RD)  
Adivtag Solutions, El Segundo, CA (RD)  
Aurum Technologies, Blackfoot, ID (RD)  
◆ AVANTech, LLC, Columbia, SC (RD)  
Berkeley Nucleonics Corp., San Rafael, CA  
(RD)  
Berthold Technologies USA LLC, Oak Ridge,  
TN (RD)  
Bertin Technologies, France (RD)  
BHI Energy - now Westinghouse, See listing  
for Westinghouse Electric Co., Cranberry  
Township, PA (RD)  
◆ Bot Engineering Ltd, Campbellville, Ontario,  
Canada (RD)  
Cabrera Services Inc., East Hartford, CT (RD)  
Chesapeake Nuclear Services, Inc., Annapolis,  
MD (RD)  
ENVINET GmbH, Munich/Haar, Germany  
(RD)  
Environmental Restoration Group, Inc.,  
Albuquerque, NM (RD)  
◆ F&J SPECIALTY PRODUCTS, INC., Ocala, FL  
(RD)  
◆ Framatome Inc., (North American  
Headquarters), Lynchburg, VA (RD)  
◆ Frham Safety Products, Inc., Rock Hill, SC  
(RD)  
Gamma Reality Inc., Richmond, CA (RD)  
GLSEQ, LLC, Huntsville, AL (RD)

H3D, Inc., Ann Arbor, MI (RD)  
◆ HI-Q Environmental Products Co., Inc., San  
Diego, CA (RD)  
◆ I.C.E. Service Group, Inc., Moon Township, PA  
(RD)  
LabLogic Systems, Inc., Chantilly, VA (RD)  
Mirion Technologies (Canberra) Inc., Meriden,  
CT (RD)  
ORTEC, Oak Ridge, TN (RD)  
◆ Radiation Safety & Control Services, Inc.,  
Seabrook, NH (RD)  
Scientific Sales, Inc., Oak Ridge, TN (RD)  
Technical Associates, (a Div. of US Nuclear  
Corp.), Canoga Park, CA (RD)  
Toshiba America Energy Systems Corp., West  
Allis, WI (RD)  
Tyne USA Inc., Jacksonville, FL (RD)  
Westinghouse Electric Co. LLC, Cranberry  
Township, PA (RD)

## 25300 Emergency Warning Systems (Public)

SE Sirens, Electronic  
SM Sirens, Mechanical  
SR System Readiness Reporting Systems  
TC Telephonic, Computerized  
TA Tone Alerting Radios  
V Voice Alert (Public Address)  
ARES Security Corp., Vienna, VA (SR)  
BHI Energy - now Westinghouse, See listing  
for Westinghouse Electric Co., Cranberry  
Township, PA (SE, TC)  
◆ Bot Engineering Ltd, Campbellville, Ontario,  
Canada (TC)  
Genave, Hampton, MN (SE, SM, SR, TA, V)  
◆ Radiation Safety & Control Services, Inc.,  
Seabrook, NH (SE)  
Westinghouse Electric Co. LLC, Cranberry  
Township, PA (SE, TC)

## 25350 Emergency Warning Systems (Worker)

Aurum Technologies, Blackfoot, ID

◆ G.D. Barri & Associates, Inc., Peoria, AZ  
◆ Framatome Inc., (North American  
Headquarters), Lynchburg, VA  
Pajarito Scientific Corp., Santa Fe, NM  
◆ Radiation Safety & Control Services, Inc.,  
Seabrook, NH

## 25400 Employment/Personnel Support Services

A Agencies  
C Craft Labor Support, Temporary  
E Executive Recruitment  
FT Full-Time Permanent Personnel  
TS Technical, Professional Support,  
Temporary

American DND Engineering, PC, Ellicottville,  
NY (TS)

◆ American DND Inc., Grand Island, NY (C)  
F.N. Anderson & Assoc., Forest, VA (FT, TS)  
Applied Analysis Corp., Reading, PA (TS)  
◆ AVANTech, LLC, Columbia, SC (TS)  
Babcock Services, Inc., Kennewick, WA (C, E,  
FT, TS)  
◆ Banda Group International, LLC, Mesa, AZ  
(TS)  
◆ G.D. Barri & Associates, Inc., Peoria, AZ (C, FT,  
TS)  
BHI Energy - now Westinghouse, See listing  
for Westinghouse Electric Co., Cranberry  
Township, PA (C, FT, TS)  
◆ Boston Government Services, LLC (BGS), Oak  
Ridge, TN (TS)  
CS-2 Inc., Grand Island, NY (A, E, FT, TS)  
◆ Curtiss-Wright Nuclear Division, Brea, CA (TS)  
Curtiss-Wright Nuclear Division, Enertech,  
Brea, CA (TS)  
DCS Systems, Inc., Simsbury, CT (TS)  
EmmEn Marketing Consultants, Pune,  
Maharashtra, India (A)  
Encorus Group, Springville, NY (FT, TS)  
◆ EnergySolutions, Salt Lake City, UT (TS)  
Engineered Rigging, Russellville, AR (C, TS)



**Barri is a MWBE staff augmentation firm that actively recruits and places engineering, professional, technical, and union craft personnel for operations, maintenance, capital improvement, and other projects primarily in the nuclear power generation industry. Our experience over the last three decades has prepared us to be an effective partner to our clients, and our knowledge of safety, labor agreements, personnel management, employment rules and regulations, together with strong labor analysis and customizable reporting capabilities will help achieve your business goals.**

<https://gdbarri.com>

◆ Denotes advertiser—see Index to Advertisers on pages 8–14

- ◆ EXCEL Services Corporation, Rockville, MD (TS)
- ◆ Framatome Inc., (North American Headquarters), Lynchburg, VA (C, TS)
- Fuel Tank Maintenance Co., LLC, Cookeville, TN (C)
- GEM Technologies, Inc., Knoxville, TN (C, TS)
- GSE Workforce Solutions, Technical Staffing, (Formerly known as Absolute Consulting), Columbia, MD (A, C, E, FT, TS)
- GSE Workforce Solutions, Training Services, (Formerly known as Hyperspring), Columbia, MD (A, C, E, FT)
- Hansell Tierney, Inc. (WBE), Mercer Island, WA (A, C, E, FT, TS)
- Human Resources Consulting, Gallatin, TN (FT)
- ◆ I.C.E. Service Group, Inc., Moon Township, PA (TS)
- James Fisher Technologies, Loveland, CO (TS)
- Merrick & Company, Greenwood Village, CO (TS)
- Navarro, Oak Ridge, TN (C, E, FT, TS)
- Numerical Advisory Solutions, LLC, Cary, NC (FT, TS)
- ◆ Paragon Energy Solutions, (Paragon), Fort Worth, TX (TS)
- ◆ Radiation Safety & Control Services, Inc., Seabrook, NH (C, TS)
- Radium Inc., Waynesboro, VA (A, C, E, FT, TS)
- ReNuke, Oak Ridge, TN (C, TS)
- S&K Logistics Services, Byron, GA (FT, TS)
- Sonic Systems International, LLC, Houston, TX (FT, TS)
- ◆ System One, Pittsburgh, PA (A, C, FT, TS)
- The Delphi Groupe, Inc., Austin, TX (A, E, FT, TS)
- TradeWind Services LLC, Richland, WA (A, TS)
- TSSD Services, Inc., Sidney, ME (TS)
- ◆ UniTech Services Group, Inc., (Div. of UniFirst Corp.), Longmeadow, MA (C, TS)
- Westinghouse Electric Co. LLC, Cranberry Township, PA (C, FT, TS)

### 25600 Encapsulation, Radioactive Source

- Alaron Nuclear Services, (Veolia Nuclear Solutions Federal Services - Alaron), Wampum, PA
- ATS Industrial Automation, Inc. - Nuclear (UK), Blaby, Leicester, United Kingdom
- ATS Industrial Automation, Inc. Nuclear (Canada), Cambridge, Ontario, Canada
- ◆ AVANTech, LLC, Columbia, SC
- BHI Energy - now Westinghouse, See listing for Westinghouse Electric Co., Cranberry Township, PA
- BWX Technologies, Inc., Lynchburg, VA
- Container Technologies Industries, LLC, Helenwood, TN
- ◆ EnergySolutions, Salt Lake City, UT
- Frontier Technology Corp., Xenia, OH
- GE Hitachi Nuclear Energy, Wilmington, NC
- International Isotopes, Inc., (RadQual), Idaho Falls, ID
- ISO-PACIFIC Remediation Technologies, Inc., Richland, WA
- Lucideon, Schenectady, NY
- MarShield Radiation Shielding, (Div. of Maxwell Metal Industries Ltd.), Burlington, Ontario, Canada
- NAC Philotechnics, Ltd., Oak Ridge, TN
- New Millennium Nuclear Technologies International, Lakewood, CO
- NSSI/Recovery Services Inc., Houston, TX
- Robatel Technologies, LLC, Roanoke, VA
- Southwest Research Institute, San Antonio, TX
- ◆ Strategic Packaging Systems, (I.C.E. Packaging Company, LLC), Madisonville, TN
- Waste Control Specialists LLC, Andrews, TX
- Westinghouse Electric Co. LLC, Cranberry Township, PA

### 25700 Energy Storage Systems, Thermal

F.N. Anderson & Assoc., Forest, VA

Black & Veatch, Overland Park, KS  
 EKIUUM, Bron Cedex, France  
 GSE Engineering, Systems & Simulation, (GSE Systems), Columbia, MD

### 26080 Environmental Monitoring Equipment

- Advanced Technologies and Laboratories (ATL) International, Inc., (wholly owned sub. of Planned Systems International, Inc.), Gaithersburg, MD
- Aurum Technologies, Blackfoot, ID
- Bertin Technologies, France
- BHI Energy - now Westinghouse, See listing for Westinghouse Electric Co., Cranberry Township, PA
- ◆ Bot Engineering Ltd, Campbellville, Ontario, Canada
- Cabrera Services Inc., East Hartford, CT
- Centronic Ltd., Surrey, United Kingdom
- ◆ Curtiss-Wright Nuclear Division, Brea, CA
- Curtiss-Wright Nuclear Division, QualTech NP, Cincinnati, OH
- Elcometer, Inc., Warren, MI
- ◆ Element Nuclear (NTS Labs), (Nuclear Engineering & Test Services), Huntsville, AL
- ENVINET GmbH, Munich/Haar, Germany
- Environmental Restoration Group, Inc., Albuquerque, NM
- ◆ F&J SPECIALTY PRODUCTS, INC., Ocala, FL
- ◆ Frham Safety Products, Inc., Rock Hill, SC
- Gamma Reality Inc., Richmond, CA
- GE Hitachi Nuclear Energy, Wilmington, NC
- General Atomics Electromagnetic Systems, San Diego, CA
- GSE Engineering, Systems & Simulation, (GSE Systems), Columbia, MD
- ◆ HI-Q Environmental Products Co., Inc., San Diego, CA
- JSM Protective, Inc., Port St. Lucie, FL

# system | one

## A Catalyst to Success

### Specialized Nuclear Outsourced Services and Workforce Solutions

As one of the top 3 US service providers with over 40 years of experience, System One supports the nuclear power industry to execute their complex, mission-critical initiatives through our outsourced services and workforce solutions. Our customers include domestic utilities, government laboratories supporting the US Departments of Defense and Energy, NSSS OEMs, EPCs, and other industry specialty manufacturers and service providers.

[systemone.com](http://systemone.com)



## ◆LND, Inc., Oceanside, NY

Mirion Technologies (Canberra) Inc., Meriden, CT

Navarro, Oak Ridge, TN

Nexetteq International LLC, Tampa, FL

ORTEC, Oak Ridge, TN

Overhoff Technology Corp., (A Div. of US

Nuclear Corp.), Milford, OH

Pajarito Scientific Corp., Santa Fe, NM

Perma-Fix Environmental Services, Inc., Oak Ridge, TN

## ◆Radiation Safety &amp; Control Services, Inc.,

Seabrook, NH

Radiological Solutions Inc., Rockdale, IL

Remtech Inc., The Villages, FL

Technical Associates, (a Div. of US Nuclear

Corp.), Canoga Park, CA

Teledyne Brown Engineering, Inc., Huntsville, AL

US Nuclear Corp., (Technical Associates Sub.), (Overhoff Technology Corp. Sub.), Canoga

Park, CA

Westinghouse Electric Co. LLC, Cranberry Township, PA

**26100 Environmental Monitoring Services**

Advanced Technologies and Laboratories (ATL) International, Inc., (wholly owned sub. of Planned Systems International, Inc.), Gaithersburg, MD

## ◆G.D. Barri &amp; Associates, Inc., Peoria, AZ

BHI Energy - now Westinghouse, See listing for Westinghouse Electric Co., Cranberry Township, PA

Cabrera Services Inc., East Hartford, CT

Centronic Ltd., Surrey, United Kingdom

DW James Consulting, LLC, North Oaks, MN

ECC, Burlingame, CA

Encorus Group, Springville, NY

ENVINET GmbH, Munich/Haar, Germany

Environmental Restoration Group, Inc.,

Albuquerque, NM

◆Framatome Inc., (North American Headquarters), Lynchburg, VA

◆Frham Safety Products, Inc., Rock Hill, SC

GE Hitachi Nuclear Energy, Wilmington, NC

GSE Engineering, Systems & Simulation, (GSE

Systems), Columbia, MD

◆HI-Q Environmental Products Co., Inc., San

Diego, CA

Kinectrics Inc., Toronto, Ontario, Canada

Mirion Technologies (Canberra) Inc., Meriden, CT

Murray and Trettel, Inc., Palatine, IL

Navarro, Oak Ridge, TN

New Millennium Nuclear Technologies

International, Lakewood, CO

◆NUCON International, Inc., Columbus, OH

Pajarito Scientific Corp., Santa Fe, NM

Perma-Fix Environmental Services, Inc., Oak Ridge, TN

Radiation Pros, LLC, (dba Rad Pros), Englewood, CO

◆Radiation Safety & Control Services, Inc.,

Seabrook, NH

Teledyne Brown Engineering, Inc., Huntsville, AL

Tetra Tech Inc., Richland, WA

The Delphi Groupe, Inc., Austin, TX

Veolia Nuclear Solutions - Federal Services,

Piketon, OH

Westinghouse Electric Co. LLC, Cranberry

Township, PA

**26190 Equipment Exchanges**

◆Curtiss-Wright Nuclear Division, Brea, CA

Curtiss-Wright Nuclear Division, Scientech,

Idaho Falls, ID

GE Hitachi Nuclear Energy, Wilmington, NC

**26230 Equipment Rental**

AC Air Conditioning

C Chillers

CN Containers

CT Cooling Towers

DE Detectors, Explosives

DW Detectors, Weapons

H Hydraulic Systems

IR Instruments, Radiation Detection

RL Radiochemistry Labs, Mobile

RV Remote-Operated Vehicles

R Repair, Machinery

S Scaffolding

SC Spot-Coolers

UC Underwater Cameras

VA Vacuum Systems (HEPA Filtered)

VT Valve Testers (Off-Line)

VS Ventilation Systems, HEPA Filtered

VI Video Inspection Systems

WB Whole-Body Counting Units

Advetage Solutions, El Segundo, CA (IR)

Alaron Nuclear Services, (Veolia Nuclear

Solutions Federal Services - Alaron), Wampum,

PA (CN)

◆American DND Inc., Grand Island, NY (S)

ANTECH Corp., Arvada, CO (IR, RL)

BHI Energy - now Westinghouse, See listing

for Westinghouse Electric Co., Cranberry

Township, PA (S)

◆Brokk Inc., (Sub. of Brokk-Sweden), (Nuclear

Div.), Santa Fe, NM (RV)

◆Curtiss-Wright EST Group, Hatfield, PA (H)

◆Curtiss-Wright Nuclear Division, Brea, CA (H)

Curtiss-Wright Nuclear Division, Enertech,

Brea, CA (H)

E.H. Wachs, (A Div. of ITW), Lincolnshire, IL (H,

R)

EFCO USA, Inc., Charlotte, NC (R, VT)

◆EnergySolutions, Salt Lake City, UT (IR, RL, RV,

VA)

Engineered Rigging, Russellville, AR (H, RV)

Environmental Restoration Group, Inc.,

Albuquerque, NM (IR)

◆Framatome Inc., (North American

Headquarters), Lynchburg, VA (VT)

◆I.C.E. Service Group, Inc., Moon Township, PA

(CN)

# Nuclear Radiation Detectors

**At LND we manufacture a wide range of Nuclear Radiation Detectors for your health physics, scientific, power plant, instrumentation and medical applications.**

LND's dependable and operationally proven detectors are designed and engineered for a long and stable counting life. Our exacting manufacturing procedures and strict, audited Quality Assurance policies meet ANSI/NCSL Z540.3-2006, MIL-PRF-1N, and Appendix B of 10CFR50 QC Standards. LND is an ISO 9001:2015 certified company. This is your assurance of unequaled performance.

**Call or e-mail for information.**



**WWW.LNDINC.COM**

**LND, INC.**

Since 1964

3230 Lawson Blvd · Oceanside, New York 11572

T: 516-678-6141 · F: 516-678-6704 · E: INFO@LNDINC.COM

◆ Denotes advertiser—see Index to Advertisers on pages 8–14

Integra Services Technologies Inc., Sarnia, Ontario, Canada (H)  
 ISO-PACIFIC Remediation Technologies, Inc., Richland, WA (DE, DW, IR)  
 James Fisher Technologies, Loveland, CO (RV)  
 Lenox Instrument Co., Inc., Trevese, PA (VI)  
 Master-Lee Engineered Products Inc., Latrobe, PA (UC)  
 Mirion Technologies (Canberra) Inc., Meriden, CT (IR, RL, WB)  
 NETCo, Windsor, ME (DE, DW, R)  
 ◆NUCON International, Inc., Columbus, OH (VS)  
 ORTEC, Oak Ridge, TN (IR)  
 Pajarito Scientific Corp., Santa Fe, NM (IR, VA, VS)  
 Perma-Fix Environmental Services, Inc., Oak Ridge, TN (IR)  
 PHDS Co., Knoxville, TN (RL)  
 Radiation Pros, LLC, (dba Rad Pros), Englewood, CO (IR)  
 ◆Radiation Safety & Control Services, Inc., Seabrook, NH (IR)  
 Radium Inc., Waynesboro, VA (RV, UC, VI)  
 Rexon Components, Inc., Beachwood, OH (IR)  
 River Technologies, LLC, Forest, VA (VA, VS)  
 SERCO USA, Evergreen, CO (R)  
 Technical Associates, (a Div. of US Nuclear Corp.), Canoga Park, CA (RL)  
 Transco Products Inc., Streator, IL (IR)  
 ◆UniTech Services Group, Inc., (Div. of UniFirst Corp.), Longmeadow, MA (IR)  
 University of Bristol, (Interface Analysis Centre) (South West Nuclear Hub), Bristol, United Kingdom (RV)  
 Westinghouse Electric Co. LLC, Cranberry Township, PA (CT, S)

#### 26240 Equipment Sales, Surplus

◆AVANTech, LLC, Columbia, SC  
 ◆Barnhart Nuclear Services, Fairhope, AL  
 Battery Lane LLC, Carson City, NV  
 ◆Curtiss-Wright Nuclear Division, Brea, CA  
 Curtiss-Wright Nuclear Division, Scientech, Idaho Falls, ID

EmmEn Marketing Consultants, Pune, Maharashtra, India  
 GE Hitachi Nuclear Energy, Wilmington, NC  
 ◆Paragon Energy Solutions, (Paragon), Fort Worth, TX  
 ◆The Park Company, Pasco, WA  
 Rexon Components, Inc., Beachwood, OH  
 Thorburn Flex Inc., Pointe-Claire, Quebec, Canada  
 ◆Westinghouse Electric Company LLC, (Westinghouse Parts Business), New Stanton, PA

#### 26390 Extensometers, Ultrasonic

Integra Services Technologies Inc., Sarnia, Ontario, Canada

#### 26410 Extruded Outlets (Pipe)

AECON-WACHS, (U.S. Div. of Aecon Nuclear), Jackson, SC  
 Tioga Pipe, Philadelphia, PA

#### 26500 Fabricating Equipment, Metal & Ceramic

Baker Industries, a Lincoln Electric Company, Macomb, MI  
 James Fisher Technologies, Loveland, CO  
 Merrick & Company, Greenwood Village, CO  
 Paxton & Vierling Steel, Carter Lake, IA  
 ◆Petersen Inc. (A Precinmac Company), Ogden, UT  
 Premier Technology, Inc., Blackfoot, ID  
 ◆Strategic Packaging Systems, (I.C.E. Packaging Company, LLC), Madisonville, TN

#### 26550 Fabrics, Flame-Retardant

◆Alphasource, Inc., Philadelphia, PA  
 Coastal Network, Inc, Charlottesville, VA  
 Lancs Industries, Albuquerque, NM  
 Mohawk Safety, Inc., Manchester, CT  
 PMT Nuclear, Woodridge, IL  
 ◆Reef Industries, Inc., (Griffolyn, Div. of Reef Industries, Inc.), Houston, TX

Rich Industries Inc., New Philadelphia, OH  
 Scientific Sales, Inc., Oak Ridge, TN  
 ◆UniTech Services Group, Inc., (Div. of UniFirst Corp.), Longmeadow, MA

#### 26600 Fall Protection Equipment & Devices, Construction & Maintenance

◆Alphasource, Inc., Philadelphia, PA  
 Eastern Technologies, Inc., (OREX; PolyZolv), Ashford, AL  
 ◆Frham Safety Products, Inc., Rock Hill, SC  
 JSM Protective, Inc., Port St. Lucie, FL  
 Mohawk Safety, Inc., Manchester, CT  
 Scientific Sales, Inc., Oak Ridge, TN

#### 26900 Fasteners

B Bolts  
 CG Commercial Grade Dedication  
 N Nuts  
 QT Quick Throw  
 S Studs  
 TR Threaded Rod  
 W Washers  
 AECON-WACHS, (U.S. Div. of Aecon Nuclear), Jackson, SC (B, N, QT, S, TR, W)  
 Carolina Fabricators, West Columbia, SC (B, CG, N, QT, S, TR, W)  
 Consolidated Power Supply, (Div. of Consolidated Pipe & Supply Co., Inc.), Birmingham, AL (B, N, QT, S, TR, W)  
 Cross Manufacturing Co. (1938) Ltd., Bath, United Kingdom (W)  
 ◆Curtiss-Wright Nuclear Division, Brea, CA (B, N, S, TR, W)  
 Curtiss-Wright Nuclear Division, Nova, Middleburg Heights, OH (B, N, S, TR, W)  
 ◆DuBoise National Energy Services, Inc., Clinton, NC (B, N, QT, S, TR, W)  
 Energy Steel, Rochester Hills, MI (B, S, W)  
 ◆Framatome Inc., (North American Headquarters), Lynchburg, VA (B, N, S, TR, W)

## ANS's open access platform open for submissions

### Nuclear Science and Technology Open Research (NSTOR) complements ANS's current publishing portfolio

- Expands and diversifies ANS publishing options by allowing unique and diverse article types, such as reports and data notes
- Provides the nuclear community with a fully OA publishing option
- Meets the OSTP Nelson memo requirements regarding open research publishing for federally funded research
- 100% discount on APC fees through December 31, 2024



Go to [nstopenresearch.org](https://nstopenresearch.org) to submit your research, or email [nstor@ans.org](mailto:nstor@ans.org) for more information.

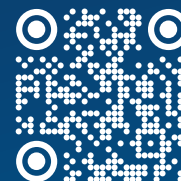

- GE Hitachi Nuclear Energy, Wilmington, NC (B, N, S, TR, W)  
Joseph Oat Corp., Camden, NJ (B, N, QT, S, TR, W)  
Lincoln Structural Solutions, Louisville, NE (B, N, QT, S, TR, W)  
Mirion Technologies, Inc., (Sensing Systems Div.), Atlanta, GA (B, S, TR)  
NuSource LLC, Alexandria, VA (B, N, S)  
♦ Paragon Energy Solutions, (Paragon), Fort Worth, TX (B, CG, N, QT, S, TR, W)  
Paxton & Vierling Steel, Carter Lake, IA (B)  
PMT Nuclear, Woodridge, IL (B, CG, N, S, TR, W)  
Scientific Sales, Inc., Oak Ridge, TN (B, CG, N, QT, S, TR, W)  
♦ T&T Enterprises, Corona, CA (B, N, S, TR, W)  
Tioga Pipe, Philadelphia, PA (B, N, S, TR, W)  
Trust Manufacturing, LLC, Euclid, OH (B, CG, N, QT, S, TR, W)  
TW Metals - Nuclear Materials Solutions, Linden, MI (B, N, S, TR, W)  
UCC Industries International Inc., Pickering, Ontario, Canada (B, N, S, TR, W)  
Westinghouse Electric Co. LLC, Cranberry Township, PA (B, N, S, TR, W)  
♦ Westinghouse Electric Company LLC, (Westinghouse Parts Business), New Stanton, PA (B, N, QT, S, TR, W)

### 26910 Feedthroughs, Bulkhead

- E Electrical  
F Fiber Optic  
AFO Research Inc., Vero Beach, FL (F)  
CableLAN Nuclear, Fort Myers, FL (F)  
♦ Curtiss-Wright Nuclear Division, Brea, CA (E, F)  
Curtiss-Wright Nuclear Division, QualTech NP, Cincinnati, OH (E, F)  
James Fisher Technologies, Loveland, CO (E)  
♦ Mirion Technologies (IST) Corp., (Sensing Systems Div.), Horseheads, NY (E, F)  
Mirion Technologies, Inc., (Sensing Systems Div.), Atlanta, GA (E, F)  
♦ Photonis, Brive la Gaillarde Cedex, France (E)  
Teledyne Brown Engineering, Inc., Huntsville, AL (E, F)  
Westinghouse Electric Co. LLC, Cranberry Township, PA (E)  
♦ Westinghouse Electric Company LLC, (Westinghouse Parts Business), New Stanton, PA (E, F)

### 26970 Fiber Optic Components & Systems

- AFO Research Inc., Vero Beach, FL  
BHI Energy - now Westinghouse, See listing for Westinghouse Electric Co., Cranberry Township, PA  
BWV Technologies, Inc., Lynchburg, VA  
CableLAN Nuclear, Fort Myers, FL  
♦ Curtiss-Wright Nuclear Division, Brea, CA  
Curtiss-Wright Nuclear Division, QualTech NP, Cincinnati, OH  
♦ Framatome Inc., (North American Headquarters), Lynchburg, VA  
GE Hitachi Nuclear Energy, Wilmington, NC  
GenScope, Inc., East Longmeadow, MA  
♦ Mirion Technologies (IST) Corp., (Sensing Systems Div.), Horseheads, NY  
Mirion Technologies, Inc., (Sensing Systems Div.), Atlanta, GA  
Prysman North America, Highland Heights, KY  
♦ Ultra Energy, (Weed Instrument), Round Rock, TX  
Westinghouse Electric Co. LLC, Cranberry Township, PA

### 27150 Filter Handling/Transfer Systems

- ♦ AVANTech, LLC, Columbia, SC  
Bilfinger Noell GmbH, (Dept. BEV), Wuerzburg, Germany  
♦ Curtiss-Wright Nuclear Division, Brea, CA  
Curtiss-Wright Nuclear Division, Scientech, Idaho Falls, ID  
Dufrane Nuclear Shielding Inc., (Dufrane Nuclear Inc.), Winsted, CT  
♦ Framatome Inc., (North American Headquarters), Lynchburg, VA  
Merrick & Company, Greenwood Village, CO

- ♦ NUCON International, Inc., Columbus, OH  
PMT Nuclear, Woodridge, IL  
Radiation Protection Systems, (by Alpha Safety), Groton, CT  
♦ SSM Industries, Inc., (Nuclear Div.), Pittsburgh, PA  
Tri Nuclear Corp., Troy, NY

### 27180 Filter Housings

- B Bag In/Bag Out  
M Manual Changeout  
R Remote Changeout  
SA Side Access  
W Walk-In  
♦ AVANTech, LLC, Columbia, SC (B, M, R)  
Camfil USA, Inc., Washington, NC (B, M, R, SA, W)  
Central Research Laboratories, Red Wing, MN (B, M, R)  
♦ Dominion Engineering, Inc., Reston, VA (R)  
Ellis & Watts Global Industries, Inc., (a sub. of Marmont\*, a Berkshire Hathaway company), Batavia, OH (B, M, R, SA, W)  
Energy Steel, Rochester Hills, MI (B, M)  
♦ EnergySolutions, Salt Lake City, UT (M)  
FabOhio, Inc., Uhrichsville, OH (B)  
IONEX Research Corp., Lafayette, CO (B, M, SA, W)  
JSM Protective, Inc., Port St. Lucie, FL (B)  
♦ NUCON International, Inc., Columbus, OH (B, M, R, SA, W)  
NuSource LLC, Alexandria, VA (B, M)  
Pajarito Scientific Corp., Santa Fe, NM (B)  
PAR Systems, LLC, Saint Paul, MN (R)  
PMT Nuclear, Woodridge, IL (B, M, R, SA, W)  
Radiation Protection Systems, (by Alpha Safety), Groton, CT (B, M, SA)  
Radiological Solutions Inc., Rockdale, IL (M)  
♦ SSM Industries, Inc., (Nuclear Div.), Pittsburgh, PA (B, M, R, SA, W)  
Tri Nuclear Corp., Troy, NY (M, R)

### 27250 Filter Services

- R Refill  
T Testing  
♦ Dominion Engineering, Inc., Reston, VA (T)  
Ellis & Watts Global Industries, Inc., (a sub. of Marmont\*, a Berkshire Hathaway company), Batavia, OH (R)  
♦ F&J SPECIALTY PRODUCTS, INC., Ocala, FL (T)  
IONEX Research Corp., Lafayette, CO (R, T)  
♦ NUCON International, Inc., Columbus, OH (R, T)  
Radiation Protection Systems, (by Alpha Safety), Groton, CT (R, T)

### 27450 Filters

- A Air  
C Carbon  
CL Cloth, Straining  
DE Debris  
D Disposable  
HE HEPA  
HY Hydraulic  
LO Lubricating Oil  
SB Stainless Steel, Porous, Backwash  
SU Stainless Steel, Porous, Backwash, Ultrasonic  
SP Stainless Steel, Porous, Blowback  
SS Stainless Steel, Sintered  
TF Thin-Film  
U Ultrafiltration  
V Vacuum (HEPA)  
W Water (Conventional)  
WP Water Purification  
WS Water/Steam, High-Pressure  
X X-ray  
AECON-WACHS, (U.S. Div. of Aecon Nuclear), Jackson, SC (SB, SU, SP, SS)  
Arkema, Inc., (formerly ATOFINA Chemicals, Inc.), King of Prussia, PA (C)  
♦ AVANTech, LLC, Columbia, SC (C, DE, D, LO, SB, U, W, WP)  
BHI Energy - now Westinghouse, See listing for Westinghouse Electric Co., Cranberry Township, PA (A, C, HE, V)  
Camfil USA, Inc., Washington, NC (A, C, HE, V)  
Carignan & Associates LLC, Chattanooga, TN (A, CL, D, HE)

- Carolina Fabricators, West Columbia, SC (A, HE, SB, SU, SP, SS)  
Consolidated Power Supply, (Div. of Consolidated Pipe & Supply Co., Inc.), Birmingham, AL (SB, WS)

- ♦ Curtiss-Wright Nuclear Division, Brea, CA (A, C, HE, V)  
Curtiss-Wright Nuclear Division, QualTech NP, Cincinnati, OH (A, C, HE, V)  
♦ Dominion Engineering, Inc., Reston, VA (A, SU, SS, WP)  
Ellis & Watts Global Industries, Inc., (a sub. of Marmont\*, a Berkshire Hathaway company), Batavia, OH (A, C, HE)  
♦ EnergySolutions, Salt Lake City, UT (DE, D, U, W, WP)  
♦ F&J SPECIALTY PRODUCTS, INC., Ocala, FL (A, C, HE)  
♦ Framatome Inc., (North American Headquarters), Lynchburg, VA (A, D, U, W, WP, WS)  
♦ Frham Safety Products, Inc., Rock Hill, SC (A, C, D, HE, V)  
GE Hitachi Nuclear Energy, Wilmington, NC (WP)  
♦ HI-Q Environmental Products Co., Inc., San Diego, CA (A, C)  
IONEX Research Corp., Lafayette, CO (A, C, HE)  
Joseph Oat Corp., Camden, NJ (LO, W, WP, WS)  
JSM Protective, Inc., Port St. Lucie, FL (CL, D)  
Kinectrics Inc., Toronto, Ontario, Canada (HE, V)  
Lancs Industries, Albuquerque, NM (A, D, HE)  
Mohawk Safety, Inc., Manchester, CT (A, HE)  
Newark Wire Cloth Co., Cedar Grove, NJ (CL, SB, SU, SP, SS, W)  
NFT, (by Alpha Safety Group), Golden, CO (A, C, D, HE, SS, U, WP)  
♦ NUCON International, Inc., Columbus, OH (A, C, D, HE, WP)  
NuSource LLC, Alexandria, VA (A, CL, D, HE, HY, LO, SB, SU, SP, SS, TF, U, V, W, WP, WS)  
♦ PacTec, Inc., Clinton, LA (CL)  
Pajarito Scientific Corp., Santa Fe, NM (C, HE)  
♦ Paragon Energy Solutions, (Paragon), Fort Worth, TX (A, C, LO, W)  
PMT Nuclear, Woodridge, IL (A, C, D, HE, V, W, WP)  
Premier Technology, Inc., Blackfoot, ID (HE)  
Radiation Protection Systems, (by Alpha Safety), Groton, CT (A, C, HE, U, V)  
♦ Radiation Safety & Control Services, Inc., Seabrook, NH (A, C)  
Radiological Solutions Inc., Rockdale, IL (W, WP)  
River Technologies, LLC, Forest, VA (A, HE, V, WS)  
Siempelkamp NIS, Alzenau, Germany (A, HE, WP)  
Toshiba America Energy Systems Corp., West Allis, WI (U, WP)  
Tri Nuclear Corp., Troy, NY (C, D, SB, W, WP)  
Westinghouse Electric Co. LLC, Cranberry Township, PA (A, C, HE, V)  
♦ Westinghouse Electric Company LLC, (Westinghouse Parts Business), New Stanton, PA (A, C, CL, D, HE, HY, LO, SB, SU, SP, SS, TF, U, V, W, WP, WS, X)

### 27650 Filters, Neutron (CdS)

- NuSource LLC, Alexandria, VA

### 28000 Fire Protection Services

- Burns & McDonnell, Kansas City, MO  
EmmEn Marketing Consultants, Pune, Maharashtra, India  
F.E. Moran Special Hazard Systems, Northbrook, IL  
♦ Framatome Inc., (North American Headquarters), Lynchburg, VA  
Numerical Advisory Solutions, LLC, Cary, NC  
Red Wolf Associates, Cary, NC  
Southwest Research Institute, San Antonio, TX

### 28100 Fire Protection, Extinguishers & Suppression

- ANKUG Engineering Co., Ltd., Seoul, Korea (The Republic of)  
♦ Framatome Inc., (North American Headquarters), Lynchburg, VA



# TT&T®

## NUCLEAR FASTENERS

**WE MOVE FAST FOR YOU®**



**CONTACT US FOR A QUOTE**

[WWW.TTENTERPRISES.COM/CONTACTUSTODAY](http://WWW.TTENTERPRISES.COM/CONTACTUSTODAY) OR CALL 951.340.0911

**28150 Fire Protection, Passive**

E Engineering Services  
 FB Fire Barriers  
 FW Fire Wrap  
 I Installation Services  
 P Penetration Seals

Adam Brown Consulting, Inc., Cary, IL (E, FW, P)  
 Advanced Nuclear LLC, Aston, PA (E, FB, FW, I, P)  
 Black & Veatch, Overland Park, KS (E)  
 Burns & McDonnell, Kansas City, MO (E)  
 ♦Curtiss-Wright Nuclear Division, Brea, CA (FB, P)  
 Curtiss-Wright Nuclear Division, QualTech NP, Cincinnati, OH (FB, P)  
 ♦Framatome Inc., (North American Headquarters), Lynchburg, VA (E, I)  
 GSE Engineering, Design & Analysis, (Formerly known as DP Engineering), Fort Worth, TX (E)  
 GSE Engineering, Systems & Simulation, (GSE Systems), Columbia, MD (E)  
 InfoTech NorthStar, Richland, WA (E)  
 Jensen Hughes, Baltimore, MD (E)  
 Numerical Advisory Solutions, LLC, Cary, NC (E)  
 Red Wolf Associates, Cary, NC (E)  
 Sigma Science, Inc., Albuquerque, NM (E)  
 Southwest Research Institute, San Antonio, TX (E)  
 TradeWind Services LLC, Richland, WA (E)  
 Transco Products Inc., Streator, IL (FB, FW, P)  
 United Engineers & Constructors, Inc., (Sub. of Imperia Engineering Partners), Mount Laurel, NJ (E)

**28250 Fireproofing Materials**

Advanced Nuclear LLC, Aston, PA  
 Arkema, Inc., (formerly ATOFINA Chemicals, Inc.), King of Prussia, PA  
 PAR Systems, LLC, Saint Paul, MN  
 Paxton & Vierling Steel, Carter Lake, IA

**28270 Firestops**

Advanced Nuclear LLC, Aston, PA  
 Electrical Builders Inc. (EBI), St. Cloud, MN

**28300 Fission Chambers**

Baker Industries, a Lincoln Electric Company, Macomb, MI  
 Centronic Ltd., Surrey, United Kingdom  
 GE Hitachi Nuclear Energy, Wilmington, NC  
 ♦LND, Inc., Oceanside, NY  
 ♦Major Tool & Machine, (A Precinmac Company), Indianapolis, IN  
 ♦Mirion Technologies (IST) Corp., (Sensing Systems Div.), Horseheads, NY  
 Mirion Technologies, Inc., (Sensing Systems Div.), Atlanta, GA  
 ♦Paragon Energy Solutions, (Paragon), Fort Worth, TX  
 ♦Photonis, Brive la Gaillarde Cedex, France  
 Toshiba America Energy Systems Corp., West Allis, WI

**28390 Fittings, Hose**

Basic E, Inc., Charlotte, VT  
 Carolina Fabricators, West Columbia, SC  
 Special Electronics & Designs Inc., (SED Inc.), Kincardine, Ontario, Canada  
 Thorburn Flex Inc., Pointe-Claire, Quebec, Canada  
 Tioga Pipe, Philadelphia, PA  
 Trust Manufacturing, LLC, Euclid, OH  
 TW Metals - Nuclear Materials Solutions, Linden, MI  
 UCC Industries International Inc., Pickering, Ontario, Canada  
 ♦Westinghouse Electric Company LLC, (Westinghouse Parts Business), New Stanton, PA

**28400 Fittings, Pipe**

AS Alloy Steel  
 CS Carbon Steel  
 SS Stainless Steel

BC Branch Connections  
 BS Butt weld, Seamless  
 BW Butt weld, Welded  
 CM Chrome Moly  
 FS Forged Steel, Socket Weld  
 FT Forged Steel, Threaded  
 NQ Nuclear Quality  
 SP Special-Purpose

AECON-WACHS, (U.S. Div. of Aecon Nuclear), Jackson, SC (AS, CS, SS, BC, BS, BW, CM, FS, FT, NQ, SP)  
 Basic E, Inc., Charlotte, VT (CS, SS, BS, BW, CM, FS, FT)  
 Carolina Fabricators, West Columbia, SC (AS, CS, SS, BC, BS, BW, CM, FS, FT, NQ, SP)  
 Centronic Ltd., Surrey, United Kingdom (AS, CS, SS, BS, BW, FS, FT, NQ, SP)  
 Consolidated Power Supply, (Div. of Consolidated Pipe & Supply Co., Inc.), Birmingham, AL (AS, CS, SS, BC, BS, BW, CM, FS, FT, NQ, SP)  
 Cross Manufacturing Co. (1938) Ltd., Bath, United Kingdom (AS, SS)  
 ♦Curtiss-Wright EST Group, Hatfield, PA (SP)  
 ♦Curtiss-Wright Nuclear Division, Brea, CA (AS, CS, SS, NQ, SP)  
 Curtiss-Wright Nuclear Division, Nova, Middleburg Heights, OH (AS, CS, SS, NQ, SP)  
 Curtiss-Wright Nuclear Division, QualTech NP, Cincinnati, OH (SS, NQ, SP)  
 ♦DuBose National Energy Services, Inc., Clinton, NC (AS, CS, SS, BC, BS, BW, CM, FS, FT, NQ, SP)  
 E.S. Fox Limited, Niagara Falls, Ontario, Canada (AS)  
 Energy Steel, Rochester Hills, MI (NQ)  
 Engineered Rigging, Russellville, AR (AS, CS, SS, SP)  
 Joseph Oat Corp., Camden, NJ (AS, CS, SS, BC, BS, BW, CM, FS, FT, NQ, SP)  
 Kinectrics Inc., Toronto, Ontario, Canada (NQ)  
 Lincoln Structural Solutions, Louisville, NE (AS, CS, SS, BS, FT, NQ)  
 NuSource LLC, Alexandria, VA (CS, SS, BC, BS, BW, NQ, SP)  
 ♦Paragon Energy Solutions, (Paragon), Fort Worth, TX (AS, CS, SS, BC, BS, BW, NQ)  
 Piping Technology & Products, Inc., Houston, TX (AS, CS, SS, BW, NQ)  
 PMT Nuclear, Woodridge, IL (AS, CS, SS, BC, BS, BW, FS, FT, NQ, SP)  
 ♦SSM Industries, Inc., (Nuclear Div.), Pittsburgh, PA (AS, CS, SS, BS, BW, NQ)  
 Teledyne Brown Engineering, Inc., Huntsville, AL (AS, CS, SS, BC, BS, BW, CM, FS, FT, NQ, SP)  
 Tioga Pipe, Philadelphia, PA (AS, CS, SS, BC, BS, BW, FS, FT, NQ, SP)  
 Trust Manufacturing, LLC, Euclid, OH (NQ, SP)  
 TW Metals - Nuclear Materials Solutions, Linden, MI (AS, CS, SS, BC, BS, BW, CM, FS, FT, NQ, SP)  
 UCC Industries International Inc., Pickering, Ontario, Canada (CS, SS)  
 ♦Westinghouse Electric Company LLC, (Westinghouse Parts Business), New Stanton, PA (AS, CS, SS, BC, BS, BW, CM, FS, FT, NQ, SP)

**28410 Fittings, Tube**

AECON-WACHS, (U.S. Div. of Aecon Nuclear), Jackson, SC  
 Carolina Fabricators, West Columbia, SC  
 Consolidated Power Supply, (Div. of Consolidated Pipe & Supply Co., Inc.), Birmingham, AL  
 ♦DuBose National Energy Services, Inc., Clinton, NC  
 Lincoln Structural Solutions, Louisville, NE  
 Tioga Pipe, Philadelphia, PA  
 TW Metals - Nuclear Materials Solutions, Linden, MI  
 ♦Westinghouse Electric Company LLC, (Westinghouse Parts Business), New Stanton, PA

**28500 Flange Refacing Equipment (On-Site)**

AECON-WACHS, (U.S. Div. of Aecon Nuclear), Jackson, SC

BWX Technologies, Inc., Lynchburg, VA  
 E.H. Wachs, (A Div. of ITW), Lincolnshire, IL  
 EFCO USA, Inc., Charlotte, NC  
 SERCO USA, Evergreen, CO

**28530 Flanges, Pipe**

CM Chrome Moly  
 C Commercial Grade  
 S Stainless  
 AECON-WACHS, (U.S. Div. of Aecon Nuclear), Jackson, SC (CM, C, S)  
 Carolina Fabricators, West Columbia, SC (CM, C, S)  
 Centronic Ltd., Surrey, United Kingdom (S)  
 Consolidated Power Supply, (Div. of Consolidated Pipe & Supply Co., Inc.), Birmingham, AL (CM, C, S)  
 ♦Curtiss-Wright Nuclear Division, Brea, CA (S)  
 Curtiss-Wright Nuclear Division, QualTech NP, Cincinnati, OH (S)  
 ♦DuBose National Energy Services, Inc., Clinton, NC (CM, C, S)  
 E.H. Wachs, (A Div. of ITW), Lincolnshire, IL (CM, C, S)  
 E.S. Fox Limited, Niagara Falls, Ontario, Canada (CM)  
 Joseph Oat Corp., Camden, NJ (CM, S)  
 Lincoln Structural Solutions, Louisville, NE (C, S)  
 NuSource LLC, Alexandria, VA (CM, S)  
 ♦Paragon Energy Solutions, (Paragon), Fort Worth, TX (S)  
 PMT Nuclear, Woodridge, IL (C, S)  
 PROTEM USA LLC, Evergreen, CO (CM, C, S)  
 Tioga Pipe, Philadelphia, PA (CM, C, S)  
 Trust Manufacturing, LLC, Euclid, OH (CM, S)  
 TW Metals - Nuclear Materials Solutions, Linden, MI (CM, C, S)  
 ♦Westinghouse Electric Company LLC, (Westinghouse Parts Business), New Stanton, PA (CM, C, S)

**28550 Flanges, Pressure Vessel**

AECON-WACHS, (U.S. Div. of Aecon Nuclear), Jackson, SC  
 Carolina Fabricators, West Columbia, SC  
 Consolidated Power Supply, (Div. of Consolidated Pipe & Supply Co., Inc.), Birmingham, AL  
 ♦DuBose National Energy Services, Inc., Clinton, NC  
 E.S. Fox Limited, Niagara Falls, Ontario, Canada  
 ♦Framatome Inc., (North American Headquarters), Lynchburg, VA  
 Joseph Oat Corp., Camden, NJ  
 Lincoln Structural Solutions, Louisville, NE  
 ♦Mirion Technologies (IST) Corp., (Sensing Systems Div.), Horseheads, NY  
 Mirion Technologies, Inc., (Sensing Systems Div.), Atlanta, GA  
 NuSource LLC, Alexandria, VA  
 Tioga Pipe, Philadelphia, PA  
 TW Metals - Nuclear Materials Solutions, Linden, MI  
 ♦Westinghouse Electric Company LLC, (Westinghouse Parts Business), New Stanton, PA

**29200 Foils**

C Carbon  
 M Metal  
 SI Stable Isotope  
 UT Ultra-Thin  
 C.J. Enterprises, (Div. of C.J. Instruments, Inc.), Tarzana, CA (M, UT)

**29360 Foreign Material Exclusion**

♦Alphasource, Inc., Philadelphia, PA  
 Desco Mfg. Co., Inc., Rancho Santa Margarita, CA  
 JSM Protective, Inc., Port St. Lucie, FL  
 The Perma-Type Company, Inc., Plainville, CT  
 Westinghouse Electric Co. LLC, Cranberry Township, PA





## FOR THE MOST TENACIOUS DEFENSE AGAINST FOREIGN MATERIAL AND DROPPED OBJECTS:

CALL ALPHASOURCE: 215.844.6470 • [Support@alphasourceintl.com](mailto:Support@alphasourceintl.com)

Alphasource, a leading provider to the International Power Generation Industry, offers the highest quality Foreign Material Exclusion (FME) control devices meeting NFPA 701 Test Method 2 and NFPA 805 standards. Widely adopted across the U.S. and in over 30 countries, our covers provide efficient, tape-free installation, long-term reusability, and cost savings. Contact Alphasource today for effective and economical solutions to optimize plant efficiency.



Explore our ToolSaver® Drop Prevention Line, designed to mitigate the risks of dropped objects in the workplace. With over 100 unique Tool Tethering products, all certified to ISEA/ANSI 121-2018 standards, The ToolSaver® Product Portfolio caters to a diverse set of tool tethering needs. Our line was developed by professionals with iterative design principles, to ensure that each product is addressing a known dropped object problem experience at worksites across the country. Our industry experts can help you and your team create a customized Dropped Object Prevention Program that saves lives, reduces the risk of injury, and protects critical systems at your Nuclear Power Station.



**29900 Fuel Channels**

ATS Industrial Automation, Inc. - Nuclear (UK), Blaby, Leicester, United Kingdom  
 ATS Industrial Automation, Inc. Nuclear (Canada), Cambridge, Ontario, Canada  
 BWX Technologies, Inc., Lynchburg, VA  
 ♦Framatome Inc., (North American Headquarters), Lynchburg, VA  
 GE Hitachi Nuclear Energy, Wilmington, NC  
 Toshiba America Energy Systems Corp., West Allis, WI  
 Westinghouse Electric Co. LLC, Cranberry Township, PA

**30000 Fuel Element Cladding**

BWX Technologies, Inc., Lynchburg, VA  
 ♦Framatome Inc., (North American Headquarters), Lynchburg, VA  
 FuseRing Inc., London, Ontario, Canada  
 GE Hitachi Nuclear Energy, Wilmington, NC  
 Westinghouse Electric Co. LLC, Cranberry Township, PA

**30040 Fuel Element Consolidation (Spent Fuel)**

SE Services  
 SY Systems  
 ATS Industrial Automation, Inc. - Nuclear (UK), Blaby, Leicester, United Kingdom (SY)  
 ATS Industrial Automation, Inc. Nuclear (Canada), Cambridge, Ontario, Canada (SY)  
 Babcock Services, Inc., Kennewick, WA (SE, SY)  
 Curtiss-Wright Nuclear Division, Scientech, Idaho Falls, ID (SE, SY)  
 ♦EnergySolutions, Salt Lake City, UT (SE, SY)  
 ♦Framatome Inc., (North American Headquarters), Lynchburg, VA (SE, SY)  
 ♦NAC International Inc., Peachtree Corners, GA (SE)  
 NuclearConsultants.com, Ann Arbor, MI (SE, SY)  
 Orano USA, Bethesda, MD (SE)  
 Pajarito Scientific Corp., Santa Fe, NM (SE)  
 PTP Spent Fuel Services, LLC, Grand Island, NY (SE, SY)  
 Westinghouse Electric Co. LLC, Cranberry Township, PA (SE, SY)

**30450 Fuel Elements, Fabricated**

C Conventional  
 ES Fuel Electrical Simulator  
 MO Mixed Oxide  
 American Centrifuge Operating, LLC, (sub. of Centrus Energy), Oak Ridge, TN (C)  
 BWX Technologies, Inc., Lynchburg, VA (C)  
 Carolina Fabricators, West Columbia, SC (C, ES, MO)  
 ♦Framatome Inc., (North American Headquarters), Lynchburg, VA (C, MO)  
 GE Hitachi Nuclear Energy, Wilmington, NC (C)  
 Orano USA, Bethesda, MD (C, MO)  
 Primm Consulting, LLC, Knoxville, TN (MO)  
 THERMOCOAX SAS, Caligny, France (ES)  
 Westinghouse Electric Co. LLC, Cranberry Township, PA (C)

**30500 Fuel Handling Equipment & Systems**

CC Computer Control Systems  
 FT Fuel Transfer Equipment  
 IP In-Pile Inspection & Manipulation  
 QC Quick Closures, Fuel Transfer Tube  
 R Refueling Equipment  
 RS Refueling Shielding  
 SP Service Platform Modification/Upgrade  
 AECON-WACHS, (U.S. Div. of Aecon Nuclear), Jackson, SC (FT, QC, SP)  
 ATS Industrial Automation, Inc. - Nuclear (UK), Blaby, Leicester, United Kingdom (R, SP)  
 ATS Industrial Automation, Inc. Nuclear (Canada), Cambridge, Ontario, Canada (R, SP)  
 Baker Industries, a Lincoln Electric Company, Macomb, MI (FT)

Bilfinger Noell GmbH, (Dept. BEV), Wuerzburg, Germany (FT, R)  
 BWX Technologies, Inc., Lynchburg, VA (CC, FT, IP, QC, R, RS, SP)  
 Carolina Fabricators, West Columbia, SC (FT, RS)  
 ♦Curtiss-Wright Nuclear Division, Brea, CA (CC, FT, IP, QC, R)  
 Curtiss-Wright Nuclear Division, Scientech, Idaho Falls, ID (CC, FT, IP, QC, R)  
 ♦Dominion Engineering, Inc., Reston, VA (IP)  
 ♦DuBose National Energy Services, Inc., Clinton, NC (SP)  
 ♦EnergySolutions, Salt Lake City, UT (FT)  
 ♦Framatome Inc., (North American Headquarters), Lynchburg, VA (CC, FT, IP, R, RS, SP)  
 Fuel Tank Maintenance Co., LLC, Cookeville, TN (FT)  
 GE Hitachi Nuclear Energy, Wilmington, NC (FT, IP, R, SP)  
 ♦Holtec International, Camden, NJ (FT, R, SP)  
 ISO-PACIFIC Remediation Technologies, Inc., Richland, WA (SP)  
 James Fisher Technologies, Loveland, CO (IP)  
 Konecranes Nuclear Equipment & Services LLC, (Formerly Morris Material Handling / P&H), New Berlin, WI (FT, R, SP)  
 ♦Major Tool & Machine, (A Precinmac Company), Indianapolis, IN (FT)  
 MarShield Radiation Shielding, (Div. of Marswell Metal Industries Ltd.), Burlington, Ontario, Canada (RS)  
 Master-Lee Engineered Products Inc., Latrobe, PA (R, SP)  
 Merrick & Company, Greenwood Village, CO (IP, R, RS)  
 Mitsubishi Nuclear Energy Systems, Inc., (A Sub. of Mitsubishi Heavy Industries, Ltd.), Charlotte, NC (CC, FT, IP, QC, R, RS, SP)  
 ♦NAC International Inc., Peachtree Corners, GA (FT)  
 Nuclear Energy Components Ltd, Hope Valley, Derbyshire, United Kingdom (R)  
 PAR Systems, LLC, Saint Paul, MN (CC, FT, IP, QC, R, RS, SP)  
 ♦The Park Company, Pasco, WA (FT, R)  
 Platom Oy, Mikkeli, Finland (FT)  
 ♦Precision Custom Components, LLC., (DC Fabricators), York, PA (R)  
 ♦Preferred Engineering Corp., (Sub. of Preferred Utilities Mfg. Corp.), Danbury, CT (FT, QC, R, RS, SP)  
 PTP Spent Fuel Services, LLC, Grand Island, NY (FT)  
 REEL COH Inc., Canada (CC, FT, QC, R, SP)  
 Robatel Technologies, LLC, Roanoke, VA (FT)  
 SKODA JS a.s., Plzen, Bolevec, Czech Republic (The) (FT)  
 Sonic Systems International, LLC, Houston, TX (IP)  
 Toshiba America Energy Systems Corp., West Allis, WI (FT, R)  
 Westinghouse Electric Co. LLC, Cranberry Township, PA (FT, QC, R)  
 ♦Westinghouse Electric Company LLC, (Westinghouse Parts Business), New Stanton, PA (CC, FT, IP, QC, R, RS, SP)

**30600 Fuel Management Services**

CTR Technical Services, Inc., Manitou Springs, CO  
 ♦Curtiss-Wright Nuclear Division, Brea, CA  
 Curtiss-Wright Nuclear Division, NETCO, Danbury, CT  
 Curtiss-Wright Nuclear Division, Scientech, Idaho Falls, ID  
 DCS Systems, Inc., Simsbury, CT  
 Equipos Nucleares, S.A., S.M.E, Maliaño (Cantabria), Spain  
 ♦Framatome Inc., (North American Headquarters), Lynchburg, VA  
 GE Hitachi Nuclear Energy, Wilmington, NC  
 Newton Research Labs, Inc., Renton, WA  
 Nuclear-21, Waasmunster, Belgium  
 NuclearConsultants.com, Ann Arbor, MI  
 Orano USA, Bethesda, MD  
 Pajarito Scientific Corp., Santa Fe, NM  
 Howard L. Sobel, P.E., Oceanside, NY  
 UxC, LLC, Roswell, GA

Westinghouse Electric Co. LLC, Cranberry Township, PA  
 ♦WMG, Inc., Peekskill, NY

**30700 Fuel Marketing Services**

F.N. Anderson & Assoc., Forest, VA  
 Battery Lane LLC, Carson City, NV  
 Ebersen, Inc., Minneapolis, MN  
 GE Hitachi Nuclear Energy, Wilmington, NC  
 Nuclear-21, Waasmunster, Belgium  
 Howard L. Sobel, P.E., Oceanside, NY  
 UxC, LLC, Roswell, GA  
 Westinghouse Electric Co. LLC, Cranberry Township, PA

**31400 Fume Hoods**

PMT Nuclear, Woodridge, IL  
 Radiation Protection Systems, (by Alpha Safety), Groton, CT  
 Scientific Sales, Inc., Oak Ridge, TN  
 ♦SSM Industries, Inc., (Nuclear Div.), Pittsburgh, PA

**31600 Furnaces**

HP Hot Press Sintering  
 NF Nuclear Fuel Sintering  
 SR Stress Relieving  
 V Vacuum  
 Deltech Furnaces, (Deltech, Inc.), Denver, CO (NF)  
 Deltech Kiln and Furnace Design, LLC, Denver, CO (NF)  
 ♦Framatome Inc., (North American Headquarters), Lynchburg, VA (NF, SR)  
 GE Hitachi Nuclear Energy, Wilmington, NC (NF)  
 MillenniTEK, LLC, Knoxville, TN (HP, V)  
 Robatel Technologies, LLC, Roanoke, VA (HP, NF)

**31650 Furniture, Control Room**

Aegis, LLC, Ooltewah, TN  
 Thinklogical, A Belden Brand, Milford, CT  
 Westinghouse Electric Co. LLC, Cranberry Township, PA

**31700 Fusion Reactor Components & Systems**

IS Isotope Separation Materials (Metal Hydrides)  
 LH Liquid Lithium Handling Systems  
 MG Microwave Generators  
 NB Neutral Beam Heaters  
 PM Pellet Manufacturing  
 RI Reactor Instrumentation & Control  
 RF RF Equipment  
 SC Structural Components  
 ATS Industrial Automation, Inc. - Nuclear (UK), Blaby, Leicester, United Kingdom (PM)  
 ATS Industrial Automation, Inc. Nuclear (Canada), Cambridge, Ontario, Canada (PM)  
 Baker Industries, a Lincoln Electric Company, Macomb, MI (SC)  
 Centronic Ltd., Surrey, United Kingdom (RI)  
 Consolidated Power Supply, (Div. of Consolidated Pipe & Supply Co., Inc.), Birmingham, AL (SC)  
 ♦Framatome Inc., (North American Headquarters), Lynchburg, VA (PM, RI, SC)  
 GE Hitachi Nuclear Energy, Wilmington, NC (PM, RI)  
 Joseph Oat Corp., Camden, NJ (SC)  
 ♦Major Tool & Machine, (A Precinmac Company), Indianapolis, IN (SC)  
 Merrick & Company, Greenwood Village, CO (SC)  
 Mirion Technologies (MGPI H&B) GmbH, (Mirion Technologies), Munich, Germany (RI)  
 ♦Paragon Energy Solutions, (Paragon), Fort Worth, TX (RI)  
 ♦Photonis, Brive la Gaillarde Cedex, France (RI)  
 Power Generation Integrated, (PGICL), Etobicoke, Ontario, Canada (LH, RI, SC)  
 Tyne USA Inc., Jacksonville, FL (IS, RI, RF)

**32250 Gas Handling Equipment**

A Adsorbents  
 C Circulators

◆ Denotes advertiser—see Index to Advertisers on pages 8–14

- G Gas Generators
- HC Hydrogen Combiners
- MP Mixers, Proportioners
- OG Off-Gas Treatment Systems
- P Purifiers

Ellis & Watts Global Industries, Inc., (a sub. of Marmon, a Berkshire Hathaway company), Batavia, OH (A, OG)

- ◆Framatome Inc., (North American Headquarters), Lynchburg, VA (HC, OG)
- GE Hitachi Nuclear Energy, Wilmington, NC (OG)
- GLSEQ, LLC, Huntsville, AL (HC)
- Inert Corp., Amesbury, MA (C, P)
- IONEX Research Corp., Lafayette, CO (A, OG)
- M. Braun, Inc., Stratham, NH (P)
- Merrick & Company, Greenwood Village, CO (OG)
- Nextteq International LLC, Tampa, FL (G)
- ◆NUCON International, Inc., Columbus, OH (A, G, OG, P)
- Pajarito Scientific Corp., Santa Fe, NM (A)
- Radiation Protection Systems, (by Alpha Safety), Groton, CT (A)
- Scientific Sales, Inc., Oak Ridge, TN (A, C, G, HC, MP, OG, P)
- ◆SSM Industries, Inc., (Nuclear Div.), Pittsburgh, PA (A)
- Teledyne Brown Engineering, Inc., Huntsville, AL (G, HC)
- Toshiba America Energy Systems Corp., West Allis, WI (A, HC, OG)
- Westinghouse Electric Co. LLC, Cranberry Township, PA (HC)

**33200 Gases**

American Centrifuge Operating, LLC, (sub. of Centrus Energy), Oak Ridge, TN  
Scientific Sales, Inc., Oak Ridge, TN

**33360 Gates, Pool**

AECON-WACHS, (U.S. Div. of Aecon Nuclear), Jackson, SC

- ◆Curtiss-Wright Nuclear Division, Brea, CA
- Curtiss-Wright Nuclear Division, QualTech NP, Cincinnati, OH
- Joseph Oat Corp., Camden, NJ
- ◆Preferred Engineering Corp., (Sub. of Preferred Utilities Mfg. Corp.), Danbury, CT
- ◆Presray Corp., (Div. of Pawling Corp.) (Critical Containment Solutions), Wassauc, NY

**33400 Gauges**

- ◆Curtiss-Wright Nuclear Division, Brea, CA
- Curtiss-Wright Nuclear Division, QualTech NP, Cincinnati, OH
- Curtiss-Wright Nuclear Division, Scientech, Idaho Falls, ID
- ◆Paragon Energy Solutions, (Paragon), Fort Worth, TX
- Scientific Sales, Inc., Oak Ridge, TN
- ◆Westinghouse Electric Company LLC, (Westinghouse Parts Business), New Stanton, PA

**33500 Gearboxes**

Nuttall Gear LLC, Niagara Falls, NY  
Schulz Electric, Timken Power Systems, East Haven, CT  
Westinghouse Electric Co. LLC, Cranberry Township, PA

**34200 Generators & Turbines, Emission Control**

- Toshiba America Energy Systems Corp., West Allis, WI
- ◆Westinghouse Electric Company LLC, (Westinghouse Parts Business), New Stanton, PA

**34800 Generators, Neutron**

Mirion Technologies (Canberra) Inc., Meriden, CT

**35650 Generators, Signal**

DT Digital Time Delay

P Pulse

- ◆Bot Engineering Ltd, Campbellville, Ontario, Canada (DT)
- Mirion Technologies (Canberra) Inc., Meriden, CT (P)
- ORTEC, Oak Ridge, TN (P)
- US Nuclear Corp., (Technical Associates Sub.), (Overhoff Technology Corp. Sub.), Canoga Park, CA (P)

**35800 Generators, Stand-by**

- Aptim, Baton Rouge, LA
- Basic E, Inc., Charlotte, VT
- ◆Paragon Energy Solutions, (Paragon), Fort Worth, TX
- Schulz Electric, Timken Power Systems, East Haven, CT
- Westinghouse Electric Co. LLC, Cranberry Township, PA
- ◆Westinghouse Electric Company LLC, (Westinghouse Parts Business), New Stanton, PA

**36000 Gloveboxes & Accessories**

- B Base Units
- C Containers
- D Drain Assemblies
- GB Glovebag Containments
- GR Glovebag Rings
- G Gloves
- P Ports

- AECON-WACHS, (U.S. Div. of Aecon Nuclear), Jackson, SC (B, C, D)
- ◆Alphasource, Inc., Philadelphia, PA (GB, G)
- Baker Industries, a Lincoln Electric Company, Macomb, MI (B, C)
- Bilfinger Noell GmbH, (Dept. BEV), Wuerzburg, Germany (P)
- Camfil USA, Inc., Washington, NC (GB)
- Carolina Fabricators, West Columbia, SC (B, C)
- Central Research Laboratories, Red Wing, MN (C, GB, GR, P)



**Learn More**



## Superior Parts from a Superior Partner

With 8 precision machining and fabrication companies across The US and Canada, Precinmac is your ideal glovebox manufacturing partner. We fabricate, machine, integrate and test gloveboxes for the nuclear and medical industries. Precinmac has over 1.8M sq. ft. of state-of-the-art manufacturing facilities equipped to handle one simple box or an entire facility. We have delivered over 25,000 high quality NQA-1 containers to our customers for over 20 years. We also provide custom manufactured equipment for decommissioning projects worldwide. When it matters, and you want high quality products, think **PRECINMAC**.

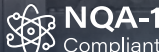

NQA-1  
Compliant



AICDS



ISO  
9001:2015



ASME  
S



ASME  
U



ASME  
U2

**Certifications & Compliances**

- ISO 13485:2016
- ISO 9001:2015
- AS9001D

- NQA-1
- CADSI / AICDS

**HOPPE**

**HPG**

**MAJOR**  
TOOL & MACHINE

**MMPCO**

**PETERSEN**

**SHIELDS**

**TRIMASTER**

**VIPER**  
NORTHWEST

- ◆Fram Safety Products, Inc., Rock Hill, SC (C, D, GB, GR, G)
- Inert Corp., Amesbury, MA (B, C, D, GB, GR, G, P)
- James Fisher Technologies, Loveland, CO (B)
- Joseph Oat Corp., Camden, NJ (B, C)
- JSM Protective, Inc., Port St. Lucie, FL (D, GR, G, P)
- Lancs Industries, Albuquerque, NM (B, C, D, GB, GR, G, P)
- M. Braun, Inc., Stratham, NH (B, C, D, GB, GR, G, P)
- ◆Major Tool & Machine, (A Precinmac Company), Indianapolis, IN (B)
- Mohawk Safety, Inc., Manchester, CT (B, C, D, GB, GR, G, P)
- NuVision-HWM, (Wälischmiller Engineering), Pittsburgh, PA (GB, GR, P)
- Orano Federal Services, Charlotte, NC (B, GB, GR)
- Orano USA, Bethesda, MD (B)
- Pajarito Scientific Corp., Santa Fe, NM (B, GR)
- ◆Petersen Inc. (A Precinmac Company), Ogden, UT (C)
- ◆Precision Custom Components, LLC., (DC Fabricators), York, PA (B, GB)
- Premier Technology, Inc., Blackfoot, ID (B, C, P)
- Radium Inc., Waynesboro, VA (B, C, GB)
- Rexon Components, Inc., Beachwood, OH (B, GR, G, P)
- Rich Industries Inc., New Philadelphia, OH (D, GR, P)
- Robatel Technologies, LLC, Roanoke, VA (B, C, D, GB, GR, P)
- Scientific Sales, Inc., Oak Ridge, TN (C, GR, G)
- ◆SSM Industries, Inc., (Nuclear Div.), Pittsburgh, PA (B)
- Teledyne Brown Engineering, Inc., Huntsville, AL (B)
- Tyne USA Inc., Jacksonville, FL (B, C, G, P)
- ◆Wagstaff Applied Technologies, Spokane, WA (B, C, D, GR, G)

- ◆Westinghouse Electric Company LLC, (Westinghouse Parts Business), New Stanton, PA (B, C, D, GB, GR, G, P)
- 
- 36800 Graphite**
- ◆Curtiss-Wright Nuclear Division, Brea, CA
  - Curtiss-Wright Nuclear Division, AP Services, Middleburg Heights, OH
- 
- 36820 Grapples**
- C Commercial Grade
  - D Drycask/Canister
  - N Nuclear (Remote-Operated)
- ◆American DND Inc., Grand Island, NY (C)
  - ◆AVANTech, LLC, Columbia, SC (N)
  - Carolina Fabricators, West Columbia, SC (C, D, N)
  - ◆EnergySolutions, Salt Lake City, UT (N)
  - James Fisher Technologies, Loveland, CO (N)
  - KUKA Systems UK Ltd, Halesowen, West Midlands, United Kingdom (N)
  - PAR Systems, LLC, Saint Paul, MN (N)
  - ◆Petersen Inc. (A Precinmac Company), Ogden, UT (D)
  - ◆Preferred Engineering Corp., (Sub. of Preferred Utilities Mfg. Corp.), Danbury, CT (D, N)
  - Premier Technology, Inc., Blackfoot, ID (D)
  - Robatel Technologies, LLC, Roanoke, VA (C, D, N)
- 
- 36850 Gratings, Catwalks, Stair Treads**
- Carolina Fabricators, West Columbia, SC
  - Consolidated Power Supply, (Div. of Consolidated Pipe & Supply Co., Inc.), Birmingham, AL
  - ◆DuBose National Energy Services, Inc., Clinton, NC
  - ◆Petersen Inc. (A Precinmac Company), Ogden, UT
  - PMT Nuclear, Woodridge, IL
  - Tioga Pipe, Philadelphia, PA

- TW Metals - Nuclear Materials Solutions, Linden, MI
  - ◆Wagstaff Applied Technologies, Spokane, WA
- 
- 36870 Grids, Fuel Element**
- BWX Technologies, Inc., Lynchburg, VA
  - ◆Framatome Inc., (North American Headquarters), Lynchburg, VA
  - GE Hitachi Nuclear Energy, Wilmington, NC
  - Joseph Oat Corp., Camden, NJ
  - Westinghouse Electric Co. LLC, Cranberry Township, PA

- 
- 36900 Grouts**
- Cutting Technologies (CTI), Gloucester City, NJ
  - Nuclear Shielding Supplies & Service, Tucson, AZ
  - ◆Westinghouse Electric Company LLC, (Westinghouse Parts Business), New Stanton, PA

---

**37130 Health Physics Equipment & Supplies**

- B Bags
- BM Biomedical Radiation-Counting Systems
- BC Body Cooling Systems
- DM Decon Mats
- DT Decon Trailers, Mobile
- DC Dosimeter Chargers
- DV Dosimeter Vests, Caps, Arm & Leg Bands
- DH Dosimeters, High-Range (Mega R)
- DP Dosimeters, Personnel
- DO Dosimetry Systems, Computerized
- DR Dosimetry Systems, Real-Time Remote
- DS Drain Socks
- EM Emergency Medical Equipment & Supplies
- E Enclosures, Radiological Containment (Temporary)
- FT Filter Test Equipment
- HS Heat Stress Monitors
- L Labels, Warning
- LB Laundry Bags



# WAGSTAFF

## APPLIED TECHNOLOGIES

**You Have an Idea...  
Wagstaff Transforms  
Concepts into Solutions.**

Since 1946, Wagstaff Applied Technologies is your single source for world-class engineering and manufacturing capabilities.

- Gloveboxes/Hot Cells
- ASME B30.20 Lifting Devices
- ASME Pressure Vessels
- Remote/Material Handling Equipment
- Containers/Casks/Overpacks
- Automated Control Systems
- Nuclear Shielding
- UL508A Control Panels

**IMPLEMENTED NUCLEAR QUALITY ASSURANCE PROGRAMS**

- ASME NQA-1 2008/2009a
- ISO 9001:2008
- 10 CFR 50 Appendix B
- ASME Div. 1 "U" Stamp
- 10 CFR 830.122
- AWS D1.1, D1.6
- 10 CFR 71, Subpart H



Contact: Dan Payne • dan.payne@wagstaff.com • 509-321-3184  
www.WagstaffAT.com • Spokane Valley, WA

◆ Denotes advertiser—see Index to Advertisers on pages 8–14

- LD Laundry Systems, Dry Cleaning
- LW Laundry Systems, Wet Wash
- MI Medical Instrumentation, Nuclear
- MS Metalized Sheetting
- MT Mops, Roll, Tacky
- PR Phantoms, Radiation-Dosimetry
- PC Planchet Changers, Automatic
- P Planchets, Counting
- RT Respirator Tracking Systems
- SI Scanners, Isotope Distribution
- S Sheetting, Plastic
- SW Signs, Warning, Radiation
- SS Smears, Swipes
- SF Stretch Wrap Film
- TW Tapes, Warning
- T Tubing, Plastic
- WC Wheel Covers
- WT Wipers, Tacky
- Advetage Solutions, El Segundo, CA (DP, DR, SI)
- ◆Alphasource, Inc., Philadelphia, PA (B, DM, DS, L, LB, MT, S, SF, TW, T, WC, WT)
- Aurum Technologies, Blackfoot, ID (DP, DO, DR, HS)
- Bertin Technologies, France (DC, DH, DP, DO, DR)
- BHI Energy - now Westinghouse, See listing for Westinghouse Electric Co., Cranberry Township, PA (DT, DO, DR, E, RT, T)
- CAEN SyS, (CAEN SpA), Viareggio, LU, Italy (DR)
- Carignan & Associates LLC, Chattanooga, TN (SS)
- Centronic Ltd., Surrey, United Kingdom (DP, DR)
- Coastal Network, Inc, Charlottesville, VA (B, DM, DC, DV, DP, E, L, LB, MT, P, S, SW, SS, TW, T, WT)
- DETEK, Temple Hills, MD (DC, DH, SW)
- Dufrane Nuclear Shielding Inc., (Dufrane Nuclear Inc.), Winsted, CT (E)
- Eastern Technologies, Inc., (OREX; PolyZolv), Ashford, AL (B, DM, DV, LB, MT, S, SF, WC, WT)
- Environmental Restoration Group, Inc., Albuquerque, NM (P, SS)
- ◆F&J SPECIALTY PRODUCTS, INC., Ocala, FL (SS)
- FabOhio, Inc., Uhrichsville, OH (B, DM, E, S, SW)
- ◆Framatome Inc., (North American Headquarters), Lynchburg, VA (DP, DO, SI)
- ◆Frham Safety Products, Inc., Rock Hill, SC (B, BC, DM, DT, DC, DV, DH, DP, DO, DR, DS, EM, E, FT, HS, L, LB, LD, LW, MI, MT, PR, PC, P, RT, S, SW, SS, SF, TW, T, WC, WT)
- Health Physics Instruments, (Div. of Far West Technology), Goleta, CA (DP)
- ◆HI-Q Environmental Products Co., Inc., San Diego, CA (P)
- Hopewell Designs, Inc., Alpharetta, GA (DC, PR)
- IONEX Research Corp., Lafayette, CO (FT)
- ISO-PACIFIC Remediation Technologies, Inc., Richland, WA (DR, SI)
- James Fisher Technologies, Loveland, CO (DT, DP, DO, DR)
- JSM Protective, Inc., Port St. Lucie, FL (B, DM, DV, DS, EM, MT, P, S, SW, SS, SF, TW, T, WC, WT)
- Lancs Industries, Albuquerque, NM (B, E, L, S, SW, T)
- ◆LND, Inc., Oceanside, NY (BM, DH, DP, DR, MI, P)
- Ludlum Measurements, Inc., Sweetwater, TX (BM)
- M. Braun, Inc., Stratham, NH (E)
- MarShield Radiation Shielding, (Div. of Marswell Metal Industries Ltd.), Burlington, Ontario, Canada (EM, E)
- Mirion Technologies (Canberra) Inc., Meriden, CT (BM, DO, MI, PR, PC, P, SI)
- Mohawk Safety, Inc., Manchester, CT (B, BC, DM, E, L, LB, MT, PC, P, S, SW, SS, TW, T, WT)
- Nextteq International LLC, Tampa, FL (B, DP)
- North Wind Group, Idaho Falls, ID (DP)
- ORTEC, Oak Ridge, TN (BM, MI, PC, P, SI)
- ◆PacTec, Inc., Clinton, LA (B, DM, DS, T)
- Perma-Fix Environmental Services, Inc., Oak Ridge, TN (HS)
- PHDS Co., Knoxville, TN (SI)
- Radiation Protection Systems, (by Alpha Safety), Groton, CT (E)
- Radium Inc., Waynesboro, VA (BC, HS, RT)
- Radkut, (Radkut by Lango's Design), Walkersville, MD (SS)
- ◆Reef Industries, Inc., (Griffolyn, Div. of Reef Industries, Inc.), Houston, TX (B, DM, DS, E, S, SW, TW, T)
- ReNuke, Oak Ridge, TN (DC)
- Rexon Components, Inc., Beachwood, OH (DP, DO, MI, PR, P)
- Rich Industries Inc., New Philadelphia, OH (B, LB, S, SW, SS, TW, T)
- S.E. International, Inc., Summertown, TN (DC, DP)
- Scientific Sales, Inc., Oak Ridge, TN (DH, DP, DO, DR, EM, HS, L, MT, SW, SS, SF, TW, T, WT)
- J. L. Shepherd & Assoc., San Fernando, CA (E)
- Tech Products, Inc., Staten Island, NY (L, SW)
- Technical Associates, (a Div. of US Nuclear Corp.), Canoga Park, CA (DP, DO, DR)
- Transco Products Inc., Streator, IL (DO)
- Tyne USA Inc., Jacksonville, FL (SS)
- ◆Ultra Energy, (Weed Instrument), Round Rock, TX (MI)
- UniTech Services Group Europe, (Sub. of UniTech Services Group USA), Coevorden, Netherlands (The) (B, DM, E, L, LB, MT, S, SW, SS, TW, T, WT)
- ◆UniTech Services Group, Inc., (Div. of UniFirst Corp.), Longmeadow, MA (B, BC, DM, DT, DV, DS, E, LB, LD, LW, MT, S, SW, SS, TW, T, WT)
- US Nuclear Corp., (Technical Associates Sub.), (Overhoff Technology Corp. Sub.), Canoga Park, CA (BM, DC, DP, DO, DR, SI)
- Westinghouse Electric Co. LLC, Cranberry Township, PA (DO, DR, RT)

## MOBILE SUPPLY STORE

UniTech's Mobile Supply Store is Your Warehouse On Wheels—Specifically Designed to Reduce Nuclear Plant Overhead Costs.



## SAVE MONEY – ONLY PAY FOR WHAT YOU USE!

UNITECH SUPPLY SERVICES CAN PROVIDE LOW COST, ONE STOP SHOPPING FOR ALL YOUR PROJECT NEEDS. UNITECH'S VAST INVENTORY MOBILIZED AND DISPENSED CONVENIENTLY AT YOUR SITE.

The Mobile Supply Store (MSS) is a highly customized semi-trailer stocked with a complete line of health physics supplies, respiratory protection, industrial safety, fall protection, confined space equipment, first aid kits, lockout/tagout systems and consumables.



mobilesupplystore

LEARN MORE AT:  
[www.unitechus.com](http://www.unitechus.com)



**37160 Health Physics Equipment & Supplies, Disposable/Soluble**

- EF Equipment & Floor Covers  
MW Mops, Wet  
W Wipers
- ◆Alphasource, Inc., Philadelphia, PA (EF, MW, W)  
Eastern Technologies, Inc., (OREX; PolyZolv), Ashford, AL (EF, MW, W)  
FEVDI Nuclear Decontamination, Corbas, France (W)  
◆Fram Safety Products, Inc., Rock Hill, SC (EF, MW, W)  
Hopewell Designs, Inc., Alpharetta, GA (EF)  
JSM Protective, Inc., Port St. Lucie, FL (EF, MW, W)  
◆PacTec, Inc., Clinton, LA (EF)  
◆Radiation Safety & Control Services, Inc., Seabrook, NH (EF)  
Rexon Components, Inc., Beachwood, OH (EF, MW, W)  
Rich Industries Inc., New Philadelphia, OH (EF)  
Scientific Sales, Inc., Oak Ridge, TN (EF, MW, W)  
UniTech Services Group Europe, (Sub. of UniTech Services Group USA), Coevorden, Netherlands (The) (EF, MW, W)

**37200 Health Physics Services**

- BF Badge Services, Film  
BT Badge Services, TLD  
BI Bioassay  
BA Breathing Air Quality Analysis  
C Calibration  
D Dosimetry Services  
EI Environmental Impact Analysis  
HC Hazard Communication (Employee)  
IH Industrial Hygiene Services  
IR Industrial Radiology  
IT Industrial Toxicology  
I In-Plant  
L Laboratory Services  
LD Laundry Services, Dry Cleaning  
LE Laundry Services, Extraction  
LW Laundry Services, Wet Wash  
MR Medical Review Officer Services  
PW Procedures Writing  
Q Quality Assurance, Quality Control  
RS Radiochemistry Services  
RE Radiological Engineering  
RI Radioimmunoassay Services  
RC Regulatory Compliance Support  
RF Respirator Fit Testing  
RT Respiratory Equipment Cleaning, Repair & Testing  
S Surveys  
TH Training, Health Physics  
TM Training, Maintenance Support  
U Urinalysis  
WB Whole-Body Counting Services

- Advanced Technologies and Laboratories (ATL) International, Inc., (wholly owned sub. of Planned Systems International, Inc.), Gaithersburg, MD (IH, PW, Q, RC, S, TH)  
Advantage Solutions, El Segundo, CA (C, PW, RE, S, TH)  
Applied Analysis Corp., Reading, PA (Q, RE)  
Aurum Technologies, Blackfoot, ID (I)  
Babcock Services, Inc., Kennewick, WA (PW, RE, RC, S, TH)  
Berkeley Nucleonics Corp., San Rafael, CA (C)  
Berthold Technologies USA LLC, Oak Ridge, TN (C)  
Bertin Technologies, France (C)  
Bevelacqua Resources, (Radiation Protection), Owens Cross Roads, AL (EI, TH)  
BHI Energy - now Westinghouse, See listing for Westinghouse Electric Co., Cranberry Township, PA (D, EI, IH, I, PW, Q, RS, RE, RC, RT, S, TH, TM)  
Cabrera Services Inc., East Hartford, CT (BI, C, D, EI, IH, L, Q, RS, RE, RC, S, TH)  
Chesapeake Nuclear Services, Inc., Annapolis, MD (EI, I, PW, Q, RS, RE, RC, TH)  
◆Constellation PowerLabs, Coatesville, PA (C, D)

- Dufrane Nuclear Shielding Inc., (Dufrane Nuclear Inc.), Winsted, CT (RE)  
DW James Consulting, LLC, North Oaks, MN (EI, Q, RE, RC)  
Eastern Technologies, Inc., (OREX; PolyZolv), Ashford, AL (LW, RT)  
ECC, Burlingame, CA (RE)  
EK USA, Inc., (EK Ekclosures, Inc.), Logan, UT (BT)

- ◆EnergySolutions, Salt Lake City, UT (C, IH, I, L, PW, Q, RS, RE, RC, S, TH, TM)  
Environmental Restoration Group, Inc., Albuquerque, NM (S, TH)  
◆F&J SPECIALTY PRODUCTS, INC., Ocala, FL (C)  
◆Framatome Inc., (North American Headquarters), Lynchburg, VA (BI, D, EI, IR, I, L, Q, RS, RE, RC, WB)  
GE Hitachi Nuclear Energy, Wilmington, NC (I, L)  
GEL Laboratories, LLC, (A Member of The GEL Group, Inc.), Charleston, SC (BI, L, RS)  
Health Physics Instruments, (Div. of Far West Technology), Goleta, CA (C)  
◆HI-Q Environmental Products Co., Inc., San Diego, CA (BA, C)  
Hopewell Designs, Inc., Alpharetta, GA (C)  
InfoTech NorthStar, Richland, WA (RE)  
ISO-PACIFIC Remediation Technologies, Inc., Richland, WA (IR)  
Kinectrics Inc., Toronto, Ontario, Canada (D, L, RS, RE, TM, U)  
L3Harris MAPPS Inc., (Power Systems and Simulation), Montreal, Quebec, Canada (TM)  
Materials and Chemistry Laboratory, Inc., (MCLinc), Oak Ridge, TN (L)  
Mirion Technologies (Canberra) Inc., Meriden, CT (C, EI, I, L, RS, RE, TH, WB)  
NAC Philotechnics, Ltd., Oak Ridge, TN (RE, S)  
Navarro, Oak Ridge, TN (IH)  
Nextteq International LLC, Tampa, FL (BA, RF)  
North Wind Group, Idaho Falls, ID (BI, BA, EI, IH, TH)  
NSSI/Recovery Services Inc., Houston, TX (C, S, TH)  
Nucleonova S.L., Valencia, Spain (Q)  
Perma-Fix Environmental Services, Inc., Oak Ridge, TN (C)  
PHDS Co., Knoxville, TN (RS, RE)  
Radiation Pros, LLC, (dba Rad Pros), Englewood, CO (BI, BA, PW, RC, S)  
Radiation Protection Systems, (by Alpha Safety), Groton, CT (RE)  
◆Radiation Safety & Control Services, Inc., Seabrook, NH (BF, BT, C, D, EI, HC, IH, IR, I, L, PW, Q, RS, RE, RC, S, TH)

**See advertisement on cover 3**

- Radiological Solutions Inc., Rockdale, IL (PW, RC)  
Red Wolf Associates, Cary, NC (RE)  
ReNuke, Oak Ridge, TN (PW, RE, S, TH)  
Schulz Electric, Timken Power Systems, East Haven, CT (S)  
Sigma Science, Inc., Albuquerque, NM (Q, RE)  
Howard L. Sobel, P.E., Oceanside, NY (Q)  
Southwest Research Institute, San Antonio, TX (EI, L, RS, RC, TH)  
Standish Technologies International, Export, PA (RC)  
Technical Management Services, Inc., New Hartford, CT (TH, TM)  
Teledyne Brown Engineering, Inc., Huntsville, AL (BI, L, RS)  
TerranearPMC, LLC, Exton, PA (RE)  
Tetra Tech Inc., Richland, WA (EI, IH, Q, RE, RC, S)  
The Delphi Groupe, Inc., Austin, TX (EI, HC, IH, I, PW, Q, RS, RE, RC, TH, TM)  
TLG Services, LLC, (sub. of Entergy Corp.), Bridgewater, CT (RE, RC, S)  
TradeWind Services LLC, Richland, WA (BI, C, D, EI, HC, IH, IR, IT, I, L, PW, Q, RS, RE, RI, RC, RF, RT, S, TH, TM)  
UniTech Services Group Europe, (Sub. of UniTech Services Group USA), Coevorden, Netherlands (The) (LE, LW, RF, RT)  
◆UniTech Services Group, Inc., (Div. of UniFirst Corp.), Longmeadow, MA (LD, LE, LW, RC, RF, RT, S)

- US Nuclear Corp., (Technical Associates Sub.), (Overhoff Technology Corp. Sub.), Canoga Park, CA (C)  
Westinghouse Electric Co. LLC, Cranberry Township, PA (D, EI, IH, I, PW, Q, RS, RE, RC, RT, S, TH, TM)  
◆WMG, Inc., Peekskill, NY (PW, RE, RC)

**37600 Heat Exchangers & Equipment**

- C Coil  
HP Heat Pipe  
P Plate/Tube  
RF Refacing Equipment (On-Site)  
S Shell/Tube  
SA Sodium/Air  
SS Sodium/Sodium  
SW Sodium/Water  
TP Tube Plugs  
W Wet Surface Air Coolers

- Advanced Cooling Technologies, Inc., Lancaster, PA (HP)

**◆Aerofin, Lynchburg, VA (C, P, S)****See advertisement on page 32**

- Baker Industries, a Lincoln Electric Company, Macomb, MI (S)  
BWX Technologies, Inc., Lynchburg, VA (S)  
Carolina Fabricators, West Columbia, SC (HP, P, S)  
Consolidated Power Supply, (Div. of Consolidated Pipe & Supply Co., Inc.), Birmingham, AL (C, HP, P, RF, S)  
◆Curtiss-Wright EST Group, Hatfield, PA (S, TP)  
◆Curtiss-Wright Nuclear Division, Brea, CA (C, P, S, TP)  
Curtiss-Wright Nuclear Division, Energetech, Brea, CA (P)  
Curtiss-Wright Nuclear Division, QualTech NP, Cincinnati, OH (C, P, S, TP)  
DC Fabricators Inc., Florence, NJ (C, P, S)  
◆DuBose National Energy Services, Inc., Clinton, NC (P, S)  
E.H. Wachs, (A Div. of ITW), Lincolnshire, IL (RF, S)  
E.S. Fox Limited, Niagara Falls, Ontario, Canada (C, HP, S)  
EFCO USA, Inc., Charlotte, NC (RF)  
Ellis & Watts Global Industries, Inc., (a sub. of Marmor\*, a Berkshire Hathaway company), Batavia, OH (C, S)  
Energy Steel, Rochester Hills, MI (C, P, S)  
Energen Corporation, (Sales Operation), Gunsan, Korea (The Republic of) (S)  
◆Framatome Inc., (North American Headquarters), Lynchburg, VA (C, P, S, SW, W)  
GE Hitachi Nuclear Energy, Wilmington, NC (S)  
Heat Exchanger Products Corp. (HEPCO), Hingham, MA (TP)  
Heatric Division of Meggitt (UK) Ltd., Poole, Dorset, United Kingdom (P, SA, SS, SW)  
Hennigan Engineering LLC, Hingham, MA (TP)  
◆Holtec International, Camden, NJ (C, P, RF, S, W)  
Joseph Oat Corp., Camden, NJ (C, S)  
◆Major Tool & Machine, (A Precinmac Company), Indianapolis, IN (S)  
Mitsubishi Nuclear Energy Systems, Inc., (A Sub. of Mitsubishi Heavy Industries, Ltd.), Charlotte, NC (C, HP, P, RF, S, SA, SS, SW, W)  
NuSource LLC, Alexandria, VA (C, HP, P, S)  
◆Paragon Energy Solutions, (Paragon), Fort Worth, TX (C, HP, P, S, SA, SS, SW)  
Piping Technology & Products, Inc., Houston, TX (S)  
Plastocor, Inc., Hingham, MA (S)  
PMT Nuclear, Woodridge, IL (C, HP, P, S)  
Powerfect Service, Inc., Brick, NJ (S)  
◆Precision Custom Components, LLC., (DC Fabricators), York, PA (S)  
Premier Technology, Inc., Blackfoot, ID (S)  
Radiological Solutions Inc., Rockdale, IL (C)  
◆Super Radiator Coils, Chaska, MN (C, P, S, W)  
Teledyne Brown Engineering, Inc., Huntsville, AL (C, HP, P, S)

IF IT HAS TO BE RELIABLE ...

CONTACT ONE OF  
OUR EXPERTS



FOR NUCLEAR COILS  
& HEAT EXCHANGERS

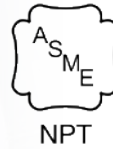

CRN

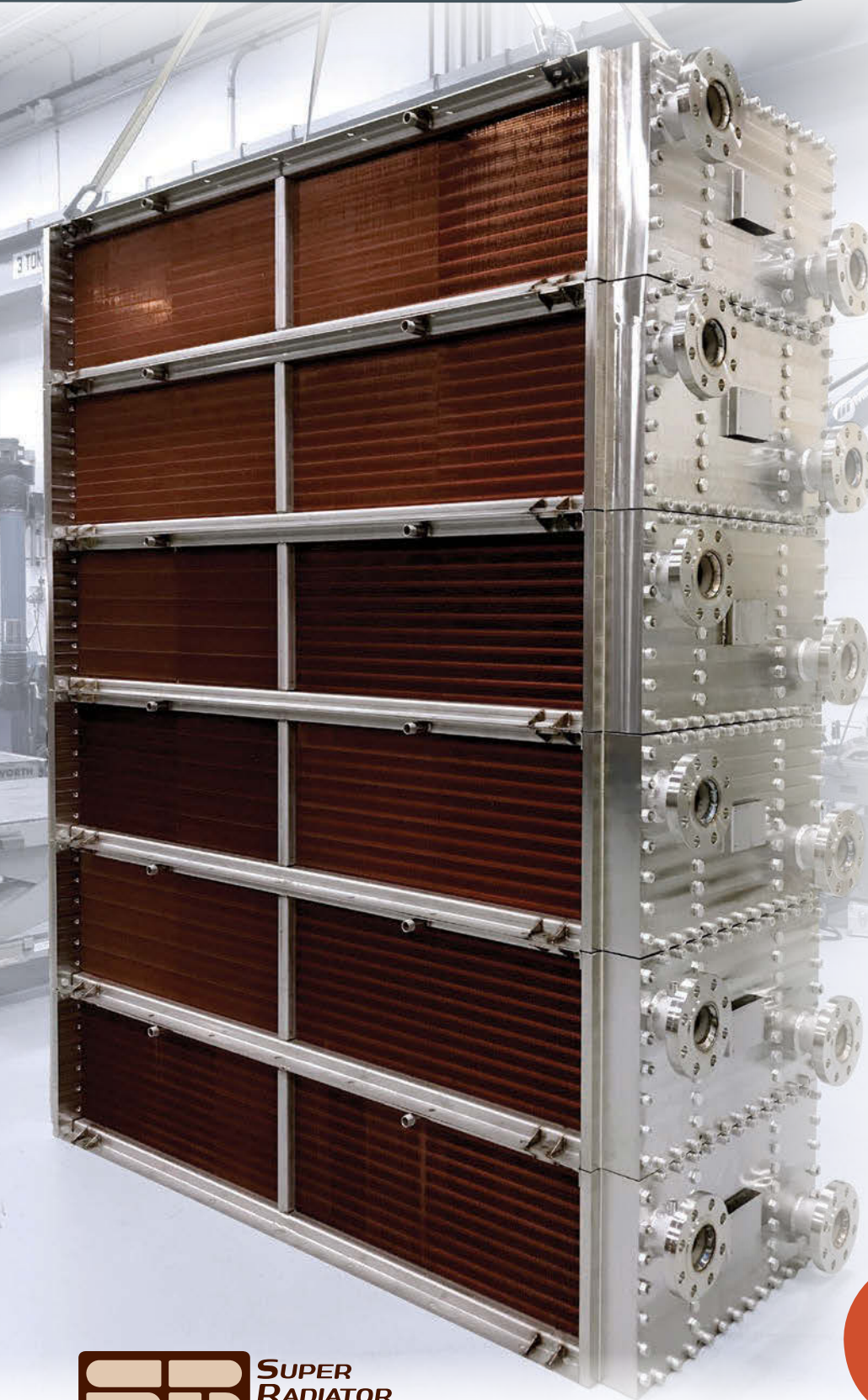

NUPIC AUDITED

... IT HAS TO BE  
**SUPER**

[superradiatorcoils.com](http://superradiatorcoils.com)



# HEAT TRANSFER SOLUTIONS FROM A SINGLE SOURCE PROVIDER

A trusted supplier to the nuclear industry since 1964, THERMAL ENGINEERING INTERNATIONAL (USA) Inc. (TEi), a Babcock Power Inc. subsidiary, offers solutions that merge cutting edge technology with worldwide, world-class service.

We've supplied over 5000 units of various heat transfer equipment with over 1000 pressure vessels to nuclear power stations, including:

Over 150 MSR's In 150 Reactor Units Worldwide

Over 625 Feedwater Heaters

Over 25 Condensers & Condenser Modules

Over 200 BOP Heat Exchangers

TEi is the Most Experienced Shop in the United States with Proven Compliance to Nuclear Industry Requirements

Learn more at [babcockpower.com/tei](http://babcockpower.com/tei)



A BABCOCK POWER INC. SUBSIDIARY



♦ Denotes advertiser—see Index to Advertisers on pages 8–14

♦ **Thermal Engineering International (TEI), Cerritos, CA (S, W)**

TW Metals - Nuclear Materials Solutions, Linden, MI (C, HP, P, S, TP)

♦ **Wagstaff Applied Technologies, Spokane, WA (C, HP, P, S)**

Westinghouse Electric Co. LLC, Cranberry Township, PA (S)

♦ **Westinghouse Electric Company LLC, (Westinghouse Parts Business), New Stanton, PA (C, HP, P, RF, S, SA, SS, SW, TP, W)**

**37660 Heat Sinks, Ultimate**

Applied Analysis Corp., Reading, PA

Black & Veatch, Overland Park, KS

Red Wolf Associates, Cary, NC

♦ **Westinghouse Electric Company LLC, (Westinghouse Parts Business), New Stanton, PA**

**37700 Heat Tracing, Electrical**

E.S. Fox Limited, Niagara Falls, Ontario, Canada

NuSource LLC, Alexandria, VA

Schulz Electric, Timken Power Systems, East Haven, CT

THERMOCOAX Inc., Alpharetta, GA

THERMOCOAX SAS, Caligny, France

♦ **Westinghouse Electric Company LLC, (Westinghouse Parts Business), New Stanton, PA**

**37720 Heat Tracing Monitoring & Control Systems**

NuSource LLC, Alexandria, VA

♦ **Westinghouse Electric Company LLC, (Westinghouse Parts Business), New Stanton, PA**

**37780 Heat Treating Services**

Energy Steel, Rochester Hills, MI

♦ **Framatome Inc., (North American Headquarters), Lynchburg, VA**

GE Hitachi Nuclear Energy, Wilmington, NC

Patriot Forge Co., Brantford, Ontario, Canada

Tioga Pipe, Philadelphia, PA

**37800 Heaters, Electric Resistance**

♦ **Curtiss-Wright Nuclear Division, Brea, CA  
Curtiss-Wright Nuclear Division, QualTech NP, Cincinnati, OH**

Ellis & Watts Global Industries, Inc., (a sub. of Marmon\*, a Berkshire Hathaway company), Batavia, OH

♦ **Framatome Inc., (North American Headquarters), Lynchburg, VA**

GE Hitachi Nuclear Energy, Wilmington, NC

NuSource LLC, Alexandria, VA

PMT Nuclear, Woodridge, IL

THERMOCOAX Inc., Alpharetta, GA

THERMOCOAX SAS, Caligny, France

♦ **Westinghouse Electric Company LLC, (Westinghouse Parts Business), New Stanton, PA**

**38000 Heaters, Feedwater**

AECON-WACHS, (U.S. Div. of Aecon Nuclear), Jackson, SC

BHI CO., LTD., Haman-gun, Korea (The Republic of)

Consolidated Power Supply, (Div. of Consolidated Pipe & Supply Co., Inc.), Birmingham, AL

Energien Corporation, (Sales Operation), Gunsan, Korea (The Republic of)

♦ **Framatome Inc., (North American Headquarters), Lynchburg, VA**

GE Hitachi Nuclear Energy, Wilmington, NC  
Heatric Division of Meggitt (UK) Ltd., Poole, Dorset, United Kingdom

♦ **Holtec International, Camden, NJ  
Joseph Oat Corp., Camden, NJ**

Powerfect Service, Inc., Brick, NJ

Sarens Nuclear & Industrial Services LLC, (Sarens), Houston, TX

♦ **Thermal Engineering International (TEI), Cerritos, CA**

Westinghouse Electric Co. LLC, Cranberry Township, PA

♦ **Westinghouse Electric Company LLC, (Westinghouse Parts Business), New Stanton, PA**

**38200 Heaters, Induction**

♦ **Westinghouse Electric Company LLC, (Westinghouse Parts Business), New Stanton, PA**

**38440 Hose**

E Elastomeric

FM Flexible Metal

I Instrumentation

TT Teflon Tube

T Thermoplastic

♦ **Alphasource, Inc., Philadelphia, PA (E)**

Basic E, Inc., Charlotte, VT (E, FM, I, TT, T)

♦ **Curtiss-Wright Nuclear Division, Brea, CA (FM)  
Curtiss-Wright Nuclear Division, QualTech NP, Cincinnati, OH (FM)**

JSM Protective, Inc., Port St. Lucie, FL (TT, T)

Mirion Technologies, Inc., (Sensing Systems Div.), Atlanta, GA (FM)

Piping Technology & Products, Inc., Houston, TX (FM, I)

PMT Nuclear, Woodridge, IL (E, FM, I, TT, T)

Rich Industries Inc., New Philadelphia, OH (T)

River Technologies, LLC, Forest, VA (E, FM)

Teledyne Brown Engineering, Inc., Huntsville, AL (FM)

Thorburn Flex Inc., Pointe-Claire, Quebec, Canada (E, FM, TT)

♦ **Westinghouse Electric Company LLC, (Westinghouse Parts Business), New Stanton, PA (E, FM, I, TT)**

**38600 Hot-Cell Wall Plugs, Sleeves**

LF Lighting Fixtures

Merrick & Company, Greenwood Village, CO (LF)

J. L. Shepherd & Assoc., San Fernando, CA

**39300 Hot Laboratories**

BWX Technologies, Inc., Lynchburg, VA

♦ **Constellation PowerLabs, Coatesville, PA**

♦ **Framatome Inc., (North American**

Headquarters), Lynchburg, VA

Hot Cell Services Corp., (HCS Corp.), Kent, WA

Kinectrics Inc., Toronto, Ontario, Canada

M. Braun, Inc., Stratham, NH

♦ **NUCON International, Inc., Columbus, OH  
Perma-Fix Environmental Services, Inc., Oak Ridge, TN**

R&G Laboratories, Inc., Tampa, FL

Robatel Technologies, LLC, Roanoke, VA

SGS North America Inc., Vallejo, CA

Southwest Research Institute, San Antonio, TX

Westinghouse Electric Co. LLC, Cranberry Township, PA

**39400 Hot Laboratory Services**

BWX Technologies, Inc., Lynchburg, VA

♦ **Constellation PowerLabs, Coatesville, PA**

♦ **Framatome Inc., (North American**

Headquarters), Lynchburg, VA

GE Hitachi Nuclear Energy, Wilmington, NC

Hot Cell Services Corp., (HCS Corp.), Kent, WA

Kinectrics Inc., Toronto, Ontario, Canada

Merrick & Company, Greenwood Village, CO

R&G Laboratories, Inc., Tampa, FL

Robatel Technologies, LLC, Roanoke, VA

SGS North America Inc., Vallejo, CA

Southwest Research Institute, San Antonio, TX

Westinghouse Electric Co. LLC, Cranberry Township, PA

**39650 Hydraulic Systems & Components**

M Mechanisms

S Systems

T Turbines

Basic E, Inc., Charlotte, VT (M)

♦ **Brokk Inc., (Sub. of Brokk-Sweden), (Nuclear Div.), Santa Fe, NM (S)**

Carolina Fabricators, West Columbia, SC (S)

♦ **Curtiss-Wright Nuclear Division, Brea, CA (M, S, T)**

Curtiss-Wright Nuclear Division, Enertech, Brea, CA

Curtiss-Wright Nuclear Division, Nova,

Middleburg Heights, OH (M, T)

E.H. Wachs, (A Div. of ITW), Lincolnshire, IL (S)

Ellis & Watts Global Industries, Inc., (a sub. of

Marmon\*, a Berkshire Hathaway company),

Batavia, OH (S)

GE Hitachi Nuclear Energy, Wilmington, NC (M,

S)

Integra Services Technologies Inc., Sarnia, Ontario, Canada (T)

James Fisher Technologies, Loveland, CO (M)

PAR Systems, LLC, Saint Paul, MN

♦ **Preferred Engineering Corp., (Sub. of Preferred Utilities Mfg. Corp.), Danbury, CT (S)**

Toshiba America Energy Systems Corp., West Allis, WI (S, T)

**39960 Imaging, Digital**

CS Consulting Services

H Hardware

RS Radiographic Scanning

RT Real-Time

S Software

3D PLUS, (Detection Systems), Versailles,

France (H, RT, S)

Arkitek Scientific, Paso Robles, CA (CS)

ASI Marine, (ASI Group Ltd.), Orchard Park, NY (CS)

Aurum Technologies, Blackfoot, ID (H, RT, S)

Cutting Technologies (CTI), Gloucester City, NJ (RS)

EmmEn Marketing Consultants, Pune,

Maharashtra, India (CS)

♦ **Framatome Inc., (North American**

Headquarters), Lynchburg, VA (CS, H, RS, RT, S)

Gamma Reality Inc., Richmond, CA (CS, H, RT, S)

General Plastics Mfg. Co., Tacoma, WA (CS)

GenScope, Inc., East Longmeadow, MA (H)

Gravis Technologies, Inc., Wallace, ID (S)

H3D, Inc., Ann Arbor, MI (H, RT, S)

ISO-PACIFIC Remediation Technologies, Inc.,

Richland, WA (RT, S)

Merrick & Company, Greenwood Village, CO

(CS, RT, S)

Newton Research Labs, Inc., Renton, WA (H)

Orano USA, Bethesda, MD (RS, RT)

Patriot Forge Co., Brantford, Ontario, Canada (S)

♦ **Thermo Scientific - CIDTEC Cameras & Imagers, (Part of Thermo Fisher Scientific), Liverpool, NY (H, RT)**

Transco Products Inc., Streator, IL (RS)

US Nuclear Corp., (Technical Associates Sub.),

(Overhoff Technology Corp. Sub.), Canoga

Park, CA (RS)

**40050 Indicators**

F Flow

LF Laminar Flow

LE LEDs

L Level

P Pressure

T Temperature

V Vibration

Automation Products, Inc., (Dynatrol Div.), Houston, TX (L)

♦ **Constellation PowerLabs, Coatesville, PA (F, LF, LE, L, P, T, V)**

♦ **Curtiss-Wright Nuclear Division, Brea, CA (F, LF, L, P, T)**

Curtiss-Wright Nuclear Division, Enertech,

Brea, CA (F, LF, L, P, T)

Curtiss-Wright Nuclear Division, QualTech NP,

Cincinnati, OH (F, L, P, T)

♦ **Element Nuclear (NTS Labs), (Nuclear Engineering & Test Services), Huntsville, AL (L, P)**

FCI-Fluid Components International, San Marcos, CA (F, L, T)

♦ **Framatome Inc., (North American**

Headquarters), Lynchburg, VA (F, L, P, T, V)

Kanata Electronic Services Ltd., (Div. of

Shawcor Ltd.), Toronto, Ontario, Canada (T)

KROHNE, (KROHNE Nuclear), Romans-sur-

Isère, France (F, L, P, T)

♦ **OITEK Corp., Tucson, AZ (F, L, P, T, V)**

- ◆ Paragon Energy Solutions, (Paragon), Fort Worth, TX (F, L, P, T)
- ◆ RdF Corporation, Hudson, NH (T)
- Scientific Sales, Inc., Oak Ridge, TN (F, LF, LE, L, P, T, V)
- Syscom Instruments S.A., Sainte-Croix, Switzerland (V)
- Technology for Energy Corp., Knoxville, TN (F)
- THERMOCOAX SAS, Caligny, France (T)
- Tyne USA Inc., Jacksonville, FL (F, LF, LE, L, P, T, V)
- Westinghouse Electric Co. LLC, Cranberry Township, PA (F, P)
- ◆ Westinghouse Electric Company LLC, (Westinghouse Parts Business), New Stanton, PA (F, LF, LE, L, P, T, V)

#### 40700 Information Services

- Black & Veatch, Overland Park, KS
- ◆ Curtiss-Wright Nuclear Division, Brea, CA
- Curtiss-Wright Nuclear Division, Scientech, Idaho Falls, ID
- Gravis Technologies, Inc., Wallace, ID
- Idaho National Laboratory, Idaho Falls, ID
- Nuclear News Magazine, Westmont, IL
- NuclearN, Phoenix, AZ
- OECD Nuclear Energy Agency (NEA), Paris, France
- Radwaste Solutions Magazine, Westmont, IL
- UxC, LLC, Roswell, GA

#### 40775 Injection Systems, Chemical

- ◆ Framatome Inc., (North American Headquarters), Lynchburg, VA

#### 40900 Inspection Services

- CN Containment
- CR Control Rods & Drives
- C Cranes & Hoists
- D Dimensional
- DS Diaphragms, Storage Tank
- EM Electric Motors
- EE Electrical, Electromechanical Equipment
- FD Foundation, Diesel Generator
- FS Foundation, Steam Generator
- FI Fuel, Irradiated
- IS In-Service
- IA Inspection Agency, ASME Code
- MS Microscopy, Scanning
- ND Nondestructive Examination
- P Pipeline
- PS Pipe Supports
- Q QA/QC
- RA Reality, Augmented
- RV Reality, Virtual
- SI Safety, Industrial
- S Siren Systems
- SO Solenoids
- ST Structures
- TP Tanks & Pools
- T Turbine
- VR Visual, Remote
- W Welding
- U Underwater, Remote, In-Service

- Adam Brown Consulting, Inc., Cary, IL (Q, SI, ST)
- AECON-WACHS, (U.S. Div. of Aecon Nuclear), Jackson, SC (CN, IS, P, PS, TP)
- ◆ Ahlberg Cameras, Wilmington, NC (VR, U)
- Applied Analysis Corp., Reading, PA (EE, Q)
- ARES Security Corp., Vienna, VA (VR)
- ASI Marine, (ASI Group Ltd.), Orchard Park, NY (IS, P, PS, TP, W, U)
- ATS Industrial Automation, Inc. - Nuclear (UK), Blaby, Leicester, United Kingdom (DS, VR, U)
- ATS Industrial Automation, Inc. Nuclear (Canada), Cambridge, Ontario, Canada (DS, VR, U)
- Baker Industries, a Lincoln Electric Company, Macomb, MI (D, ND, W)
- ◆ G.D. Barri & Associates, Inc., Peoria, AZ (Q)
- BHI Energy - now Westinghouse, See listing for Westinghouse Electric Co., Cranberry Township, PA (P, PS, T)
- Black & Veatch, Overland Park, KS (C, FD, FS, P, PS, Q, SI, TP, T)
- Bureau Veritas Inspection and Insurance Co., (previously OneCIS Inspection and Insurance Co.), Lynn, MA (IS, IA, Q, W)

- BWX Technologies, Inc., Lynchburg, VA (FI, IS, MS, ND, P, Q, TP, VR, W, U)
- Consolidated Power Supply, (Div. of Consolidated Pipe & Supply Co., Inc.), Birmingham, AL (Q)
- Constellation ClearSight, De Pere, WI (IA, P, RA, RV, TP, VR, U)
- Corrosion Control Services, Inc., Davenport, IA (DS, TP)
- CS-2 Inc., Grand Island, NY (SI)
- ◆ Curtiss-Wright Nuclear Division, Brea, CA (D, EE, IS, ND, PS, Q)
- Curtiss-Wright Nuclear Division, EnerTech, Brea, CA (IS, ND, PS, Q)
- Curtiss-Wright Nuclear Division, QualTech NP, Cincinnati, OH (D, EE, ND, Q)
- DCS Systems, Inc., Simsbury, CT (Q)
- ◆ Dominion Engineering, Inc., Reston, VA (FI)
- Electrical Builders Inc. (EBI), St. Cloud, MN (EE, VR, W)
- ◆ Element Nuclear (NTS Labs), (Nuclear Engineering & Test Services), Huntsville, AL (PS)
- ◆ Framatome Inc., (North American Headquarters), Lynchburg, VA (CN, CR, D, EE, FI, IS, MS, ND, P, PS, Q, SI, TP, VR, W, U)
- Fuel Tank Maintenance Co., LLC, Cookeville, TN (IS, ND, P, TP, T, W)
- GE Hitachi Nuclear Energy, Wilmington, NC (CR, FI, IS, ND, P, VR, U)
- Genave, Hampton, MN (S)
- Global Quality Management Advisors, Lynchburg, VA (ND, Q, ST, VR)
- GSE Solutions, (GSE Systems), Columbia, MD (IA)
- Hennigan Engineering LLC, Hingham, MA (P, VR)
- Hydro, Inc., (HydroAire Services Division), Chicago, IL (D, ND, Q, W)
- Imperia Engineering Partners LLC, Milford, MA (IA, ND, P, PS)
- In-Place Machining Company, LLC, Blue Ash, OH (U)
- International Isotopes, Inc., (RadQual), Idaho Falls, ID (ND)
- James Fisher Technologies, Loveland, CO (DS, ND, P, TP, VR, W, U)
- JME Technologies, Crystal Lake, IL (ND, VR)
- Joseph Oat Corp., Camden, NJ (ND, PS, Q, TP, W)
- K-Tek International Inc., Wilsonville, OR (MS)
- KCI Engineering Consultants, Downers Grove, IL (CN)
- Klein Consulting LLC, Norwich, CT (Q)
- Konecranes Nuclear Equipment & Services LLC, (Formerly Morris Material Handling / P&H), New Berlin, WI (C)
- L3Harris MAPPS Inc., (Power Systems and Simulation), Montreal, Quebec, Canada (RV)
- Laboratory Services, (Div. of Consumers Energy), Jackson, MI (MS, ND, P, PS, VR, W)
- Lenox Instrument Co., Inc., Trevose, PA (ND, VR)
- Mirion Technologies (Canberra) Inc., Meriden, CT (ND)
- ◆ Mirion Technologies (IST) Corp., (Sensing Systems Div.), Horseheads, NY (VR)
- Mirion Technologies, Inc., (Sensing Systems Div.), Atlanta, GA (VR)
- Mitsubishi Nuclear Energy Systems, Inc., (A Sub. of Mitsubishi Heavy Industries, Ltd.), Charlotte, NC (CN, CR, C, D, DS, FD, FS, FI, IS, IA, MS, ND, P, PS, Q, SI, S, TP, T, VR, W, U)
- National Inspection & Consultants, Fort Myers, FL (CN, CR, IS, ND, Q, TP)
- Newton Research Labs, Inc., Renton, WA (FI, ND, TP, U)
- ◆ NUCON International, Inc., Columbus, OH (IS)
- Numerical Advisory Solutions, LLC, Cary, NC (P, PS)
- Pajarito Scientific Corp., Santa Fe, NM (FI)
- PAR Systems, LLC, Saint Paul, MN (C, EE, ND, U)
- Paxton & Vierling Steel, Carter Lake, IA (Q, W)
- Perma-Fix Environmental Services, Inc., Oak Ridge, TN (Q, SI)
- PHDS Co., Knoxville, TN (ND)
- PMT Nuclear, Woodridge, IL (D, Q)
- Power Services Group, (Power Plant Services, Orbital Energy Services, Airco, Turbine Generator Maintenance), Cape Coral, FL (T)

- ◆ Precision Custom Components, LLC., (DC Fabricators), York, PA (D, ND, Q, W)
- PROTEM USA LLC, Evergreen, CO (P, W)
- ◆ Radiation Safety & Control Services, Inc., Seabrook, NH (IS, P, PS, ST, TP)
- REEL COH Inc., Canada (C)
- Rich Industries Inc., New Philadelphia, OH (CN)
- Rogante Engineering Office, Civitanova Marche, Italy (ND)
- Schulz Electric, Timken Power Systems, East Haven, CT (C, EE, IS, ND)
- SKODA JS a.s., Plzen, Bolevec, Czech Republic (The) (CR, IS, ND, W)
- Howard L. Sobel, P.E., Oceanside, NY (Q)
- Sonic Systems International, LLC, Houston, TX (CR, C, D, IS, ND, P, PS, Q, TP, T, VR, W, U)
- Southwest Research Institute, San Antonio, TX (ND, P, TP, U)
- ◆ System One, Pittsburgh, PA (IS, IA, ND, P, PS, Q, SI, TP, T, VR, W)
- Tetra Tech Inc., Richland, WA (Q)
- The Delphi Groupe, Inc., Austin, TX (Q, SI)
- ◆ Thermo Scientific - CIDTEC Cameras & Imagers, (Part of Thermo Fisher Scientific), Liverpool, NY (VR)
- Toshiba America Energy Systems Corp., West Allis, WI (IS, IA, MS, ND, P, PS, Q, T)
- ◆ Underwater Construction Corp., (Underwater Construction Corp. UK Ltd.), Essex, CT (ND, Q, TP)
- Westinghouse Electric Co. LLC, Cranberry Township, PA (CR, EE, FI, IS, ND, P, PS, Q, RA, RV, TP, T, VR, W, U)
- Young Poong Ind., Busan, Korea (The Republic of) (U)

#### 41000 Instrument Services

- Advetage Solutions, El Segundo, CA
- Berkeley Nucleonics Corp., San Rafael, CA
- Cabrera Services Inc., East Hartford, CT
- Centronic Ltd., Surrey, United Kingdom
- ◆ Constellation PowerLabs, Coatesville, PA
- ◆ Curtiss-Wright Nuclear Division, Brea, CA
- Curtiss-Wright Nuclear Division, EnerTech, Brea, CA
- ◆ EnergySolutions, Salt Lake City, UT
- Environmental Restoration Group, Inc., Albuquerque, NM
- ◆ EXCEL Services Corporation, Rockville, MD
- ◆ Framatome Inc., (North American Headquarters), Lynchburg, VA
- GE Hitachi Nuclear Energy, Wilmington, NC
- ◆ HI-Q Environmental Products Co., Inc., San Diego, CA
- Laboratory Services, (Div. of Consumers Energy), Jackson, MI
- Mirion Technologies (Canberra) Inc., Meriden, CT
- NSSI/Recovery Services Inc., Houston, TX
- ◆ NUCON International, Inc., Columbus, OH
- Pajarito Scientific Corp., Santa Fe, NM
- Perma-Fix Environmental Services, Inc., Oak Ridge, TN
- ◆ Radiation Safety & Control Services, Inc., Seabrook, NH
- Volian Enterprises, Inc., Murrysville, PA
- Warrington, Inc., Pflugerville, TX
- Westinghouse Electric Co. LLC, Cranberry Township, PA

#### 41015 Instrumentation, Misc.

- A Analyzer, Total Uranium (Water, Soils, Bioassay)
- PHDS Co., Knoxville, TN (A)
- ◆ Westinghouse Electric Company LLC, (Westinghouse Parts Business), New Stanton, PA (A)

#### 41100 Insulation, Electrical, Radiation-Resistant

- Centronic Ltd., Surrey, United Kingdom
- Kanata Electronic Services Ltd., (Div. of Shawcor Ltd.), Toronto, Ontario, Canada
- MillenniTEK, LLC, Knoxville, TN
- Schulz Electric, Timken Power Systems, East Haven, CT

♦ Denotes advertiser—see Index to Advertisers on pages 8–14

**41200 Insulation, Thermal**

B Blanket  
 C Cable  
 CT Cable Tray  
 HT High-Temperature  
 MR Metal Reflective  
 N Nuclear Quality (Q Materials)  
 PT Pipe & Tube

Advanced Nuclear LLC, Aston, PA (B, C, CT, HT, MR, N, PT)  
 Carolina Fabricators, West Columbia, SC (PT)  
 Centronic Ltd., Surrey, United Kingdom (HT, N)  
 Consolidated Power Supply, (Div. of Consolidated Pipe & Supply Co., Inc.), Birmingham, AL (N, PT)  
 JSM Protective, Inc., Port St. Lucie, FL (B, HT)  
 Kanata Electronic Services Ltd., (Div. of Shawcor Ltd.), Toronto, Ontario, Canada (N)  
 MillenniTEK, LLC, Knoxville, TN (B, HT)  
 PMT Nuclear, Woodridge, IL (B, CT, HT, MR, N, PT)  
 Transco Products Inc., Streator, IL (B, HT, MR, N, PT)

♦ Westinghouse Electric Company LLC, (Westinghouse Parts Business), New Stanton, PA (B, C, CT, HT, MR, N, PT)

**41450 Inverters (DC to AC)**

Basic E, Inc., Charlotte, VT

♦ Curtiss-Wright Nuclear Division, Brea, CA  
 Curtiss-Wright Nuclear Division, QualTech NP, Cincinnati, OH  
 GUTOR, Houston, TX

♦ Paragon Energy Solutions, (Paragon), Fort Worth, TX  
 Schaefer Electronics, Inc., Hopkinton, MA  
 Schulz Electric, Timken Power Systems, East Haven, CT  
 Toshiba America Energy Systems Corp., West Allis, WI  
 Westinghouse Electric Co. LLC, Cranberry Township, PA

♦ Westinghouse Electric Company LLC, (Westinghouse Parts Business), New Stanton, PA

**41550 Ion Chromatography**

Centronic Ltd., Surrey, United Kingdom

**41700 Ion-Exchange Systems, Materials & Services**

CS Components & Systems  
 M Materials  
 S Services

♦ AVANTech, LLC, Columbia, SC (CS, M, S)  
 Centronic Ltd., Surrey, United Kingdom (CS)  
 ♦ EnergySolutions, Salt Lake City, UT (CS, M, S)  
 ♦ Framatome Inc., (North American Headquarters), Lynchburg, VA (CS, M, S)  
 ♦ NUCON International, Inc., Columbus, OH (CS, M, S)  
 NuSource LLC, Alexandria, VA (CS)  
 Toshiba America Energy Systems Corp., West Allis, WI (CS)  
 Tri Nuclear Corp., Troy, NY (CS)  
 Veolia Nuclear Solutions - Federal Services, Piketon, OH  
 Westinghouse Electric Co. LLC, Cranberry Township, PA (CS, M, S)

**42400 Ion Sources**

NAC Philotechnics, Ltd., Oak Ridge, TN  
 Toshiba America Energy Systems Corp., West Allis, WI

**42600 Irradiation Services**

GE Hitachi Nuclear Energy, Wilmington, NC  
 General Atomics Electromagnetic Systems, San Diego, CA

♦ Paragon Energy Solutions, (Paragon), Fort Worth, TX  
 J. L. Shepherd & Assoc., San Fernando, CA  
 Southwest Research Institute, San Antonio, TX  
 Tyne USA Inc., Jacksonville, FL

**42800 Irradiators, Isotopic**

Hopewell Designs, Inc., Alpharetta, GA

J. L. Shepherd & Assoc., San Fernando, CA  
 Tyne USA Inc., Jacksonville, FL

**42870 Isolators, Electronic Signal**

♦ Curtiss-Wright Nuclear Division, Brea, CA  
 Curtiss-Wright Nuclear Division, Scientech, Idaho Falls, ID

♦ Paragon Energy Solutions, (Paragon), Fort Worth, TX  
 PHDS Co., Knoxville, TN

♦ Westinghouse Electric Company LLC, (Westinghouse Parts Business), New Stanton, PA

**43150 Isotope Separation Plants & Equipment**

ATS Industrial Automation, Inc. - Nuclear (UK), Blaby, Leicester, United Kingdom  
 ATS Industrial Automation, Inc. Nuclear (Canada), Cambridge, Ontario, Canada

**43400 Isotopes, Stable (Enriched)**

ATS Industrial Automation, Inc. - Nuclear (UK), Blaby, Leicester, United Kingdom  
 ATS Industrial Automation, Inc. Nuclear (Canada), Cambridge, Ontario, Canada  
 MillenniTEK, LLC, Knoxville, TN

**43700 Joints, Expansion**

C Conventional  
 DF Ductwork, Fabric  
 DM Ductwork, Metal  
 P Packless

Advanced Nuclear LLC, Aston, PA (C, DF, DM)  
 AECON-WACHS, (U.S. Div. of Aecon Nuclear), Jackson, SC (C, DF, DM)  
 Carolina Fabricators, West Columbia, SC (C, DM)

♦ Curtiss-Wright Nuclear Division, Brea, CA (C, DF)  
 Curtiss-Wright Nuclear Division, AP Services, Middleburg Heights, OH (C, DF)  
 Electrical Builders Inc. (EBI), St. Cloud, MN (DM)  
 Piping Technology & Products, Inc., Houston, TX (C, DF, DM)  
 PMT Nuclear, Woodridge, IL (C, DF, DM)

♦ SSM Industries, Inc., (Nuclear Div.), Pittsburgh, PA (C, DF, DM)  
 Thorburn Flex Inc., Pointe-Claire, Quebec, Canada (C, DF, DM, P)  
 U.S. Bellows, Inc., (Sub. of Piping Technology & Products, Inc.), Houston, TX (DF, DM)  
 Valiant Products, Inc., Lakeland, FL (DM)

♦ Westinghouse Electric Company LLC, (Westinghouse Parts Business), New Stanton, PA (C, DF, DM, P)

**44000 Laboratories, Mobile**

A Analytical Services, On-Site  
 E Environmental Analysis

ANTECH Corp., Arvada, CO (A, E)  
 Cabrera Services Inc., East Hartford, CT (A, E)

♦ Constellation PowerLabs, Coatesville, PA (A)  
 ♦ EnergySolutions, Salt Lake City, UT (A)  
 Kinectrics Inc., Toronto, Ontario, Canada (A, E)  
 Lambda Technologies, (Surface Enhancement Technologies, LLC and Lambda Research, Inc.), Cincinnati, OH (A)  
 Merrick & Company, Greenwood Village, CO (A)  
 Mirion Technologies (Canberra) Inc., Meriden, CT (A, E)  
 Perma-Fix Environmental Services, Inc., Oak Ridge, TN (A, E)

♦ Radiation Safety & Control Services, Inc., Seabrook, NH (A, E)  
 Tetra Tech Inc., Richland, WA (E)

**44070 Lapping Equipment, Precision**

EFCO USA, Inc., Charlotte, NC  
 SERCO USA, Evergreen, CO

**44080 Laser Equipment & Accessories**

Baker Industries, a Lincoln Electric Company, Macomb, MI

♦ Framatome Inc., (North American Headquarters), Lynchburg, VA  
 Gamma Reality Inc., Richmond, CA

♦ Major Tool & Machine, (A Precinmac Company), Indianapolis, IN  
 PAR Systems, LLC, Saint Paul, MN

**44090 Laser Scanning for Dimensional Measurement**

Baker Industries, a Lincoln Electric Company, Macomb, MI

♦ Constellation PowerLabs, Coatesville, PA

♦ Framatome Inc., (North American Headquarters), Lynchburg, VA  
 Gamma Reality Inc., Richmond, CA  
 James Fisher Technologies, Loveland, CO  
 Numerical Advisory Solutions, LLC, Cary, NC  
 PMT Nuclear, Woodridge, IL  
 Transco Products Inc., Streator, IL

**45250 Leak-Sealing Services, On-Line**

AECON-WACHS, (U.S. Div. of Aecon Nuclear), Jackson, SC

♦ Curtiss-Wright Nuclear Division, Brea, CA  
 Curtiss-Wright Nuclear Division, QualTech NP, Cincinnati, OH

♦ Framatome Inc., (North American Headquarters), Lynchburg, VA

**45280 Legal Services**

Prospect Law Ltd., London, United Kingdom

**45350 Lifts, Aerial**

Engineered Rigging, Russellville, AR

**45550 Lights, Lighting**

C Construction  
 CL Containment LED  
 E Emergency  
 EP Explosion Proof  
 HB High Bay  
 HC Hot Cell  
 L LED  
 LB Low Bay  
 P Pool, Nuclear  
 PB Portable, Battery-Powered  
 RF Reactor Floor  
 U Underwater

♦ Ahlberg Cameras, Wilmington, NC (P, U)  
 BIRNS, Inc., Oxnard, CA (CL, E, HB, HC, LB, P, RF, U)

♦ Constellation PowerLabs, Coatesville, PA (E, PB)

♦ Curtiss-Wright Nuclear Division, Brea, CA (E)  
 Curtiss-Wright Nuclear Division, QualTech NP, Cincinnati, OH (E)  
 E.S. Fox Limited, Niagara Falls, Ontario, Canada (C)

♦ Framatome Inc., (North American Headquarters), Lynchburg, VA (E, P, PB, RF, U)

♦ Frham Safety Products, Inc., Rock Hill, SC (C, E, PB)  
 James Fisher Technologies, Loveland, CO (HC)  
 Lights Camera Action, LLC, Gilbert, AZ (C, CL, HC, P, RF, U)  
 Master-Lee Engineered Products Inc., Latrobe, PA (P, RF, U)

♦ Mirion Technologies (IST) Corp., (Sensing Systems Div.), Horseheads, NY (P, U)  
 Mirion Technologies, Inc., (Sensing Systems Div.), Atlanta, GA (P, U)  
 Premier Technology, Inc., Blackfoot, ID (HC)  
 Radium Inc., Waynesboro, VA (C, E, HC, P, PB, RF, U)  
 Scientific Sales, Inc., Oak Ridge, TN (C, CL)  
 Sidus Solutions LLC, San Diego, CA (U)

♦ Westinghouse Electric Company LLC, (Westinghouse Parts Business), New Stanton, PA (C, CL, E, EP, HB, HC, LB, P, PB, RF, U)

**45700 Liners, Pool**

Bilfinger Noell GmbH, (Dept. BEV), Wuerzburg, Germany

♦ Framatome Inc., (North American Headquarters), Lynchburg, VA  
 Fuel Tank Maintenance Co., LLC, Cookeville, TN

♦ Reef Industries, Inc., (Griffolyn, Div. of Reef Industries, Inc.), Houston, TX

♦ Underwater Construction Corp., (Underwater Construction Corp. UK Ltd.), Essex, CT

**46200 Loops, Test**

- IP In-Pile  
OP Out-of-Pile
- ◆ Framatome Inc., (North American Headquarters), Lynchburg, VA (OP)  
Hydro, Inc., (HydroAire Services Division), Chicago, IL (IP, OP)  
KCI Engineering Consultants, Downers Grove, IL (OP)  
Merrick & Company, Greenwood Village, CO (IP, OP)  
SIET, Piacenza, Italy (OP)

**46810 Lubricants**

- AS Anti-Seize (High Purity)  
RR Radiation-Resistant
- Canoil Canada Ltd, Mississauga, Ontario, Canada (RR)
- ◆ Curtiss-Wright Nuclear Division, Brea, CA (AS)  
Curtiss-Wright Nuclear Division, Nova, Middleburg Heights, OH (AS)  
General Magnaplate Corp., Arlington, TX (AS, RR)
- ◆ Paragon Energy Solutions, (Paragon), Fort Worth, TX (RR)
- ◆ Westinghouse Electric Company LLC, (Westinghouse Parts Business), New Stanton, PA (AS, RR)

**46950 Machining Services**

- CN Computerized Numerical Controlled  
C Conventional  
ED Electrical Discharge (EDM)  
F Field  
L Lapping  
MD Metal Disintegration Machining  
PA Plasma Arc Cutting  
R Remote  
S Shearing  
UW Underwater
- Advanced Consulting Group, Inc., Chicago, IL (CN, C, ED, MD, PA, R, S, UW)  
AECON-WACHS, (U.S. Div. of Aecon Nuclear), Jackson, SC (C, F, L, PA, UW)  
Aptim, Baton Rouge, LA (F, R)  
Baker Industries, a Lincoln Electric Company, Macomb, MI (CN, C, ED, L, PA, R, S)  
BWX Technologies, Inc., Lynchburg, VA (CN, C, ED, F, MD, PA, R)  
Carolina Fabricators, West Columbia, SC (CN, C, ED, PA, S)  
Centronic Ltd., Surrey, United Kingdom (CN, C)
- ◆ Curtiss-Wright Nuclear Division, Brea, CA (CN, C, ED)  
Curtiss-Wright Nuclear Division, Nova, Middleburg Heights, OH (ED)  
Curtiss-Wright Nuclear Division, QualTech NP, Cincinnati, OH (CN, C, ED)  
DB2 Consulting Inc., Baltimore, Ontario, Canada (CN)
- ◆ DuBose National Energy Services, Inc., Clinton, NC (CN, C, ED, F, L, MD, PA, S)  
E.H. Wachs, (A Div. of ITW), Lincolnshire, IL (C, F, R, UW)  
EPD, Carlsbad, NM (CN, C, PA)
- ◆ Framatome Inc., (North American Headquarters), Lynchburg, VA (CN, C, ED, F, R, UW)  
GE Hitachi Nuclear Energy, Wilmington, NC (CN, C, L, R, UW)  
Hydro, Inc., (HydroAire Services Division), Chicago, IL (CN)  
In-Place Machining Company, LLC, Blue Ash, OH (F, R, UW)  
Integra Services Technologies Inc., Sarnia, Ontario, Canada (F)
- ◆ James C. White Company, Inc., Greenville, SC (CN, C, S)  
James Fisher Technologies, Loveland, CO (PA, R, UW)  
Kinectrics Inc., Toronto, Ontario, Canada (C, ED)  
Lincoln Structural Solutions, Louisville, NE (C, S)  
Lucideon, Schenectady, NY (CN, C, ED)
- ◆ Major Tool & Machine, (A Precinmac Company), Indianapolis, IN (CN, C, PA)  
MillenniTEK, LLC, Knoxville, TN (CN, C)

- Nuclear Energy Components Ltd, Hope Valley, Derbyshire, United Kingdom (CN, C)  
PAR Systems, LLC, Saint Paul, MN (R)
- ◆ Petersen Inc. (A Precinmac Company), Ogden, UT (CN, C, ED, F, L, PA, R, S, UW)  
PMT Nuclear, Woodridge, IL (CN, C, ED, PA)
- ◆ Precision Custom Components, LLC., (DC Fabricators), York, PA (CN, C, L)  
Rexon Components, Inc., Beachwood, OH (CN)  
Schulz Electric, Timken Power Systems, East Haven, CT (CN, C, ED)  
SERCO USA, Evergreen, CO (C, F, L, R, S, UW)
- ◆ T&T Enterprises, Corona, CA (CN, C, S)  
Teledyne Brown Engineering, Inc., Huntsville, AL (CN, C)  
Trust Manufacturing, LLC, Euclid, OH (CN, C, ED)
- ◆ Wagstaff Applied Technologies, Spokane, WA (CN, C)  
Westinghouse Electric Co. LLC, Cranberry Township, PA (CN, C, ED, F, L, MD, PA, R, S, UW)
- ◆ Westinghouse Electric Company LLC, (Westinghouse Parts Business), New Stanton, PA (CN, C, ED, F, L, MD, PA, R, S, UW)

**47200 Magnets**

- C Conventional  
S Superconducting
- ◆ Alphasource, Inc., Philadelphia, PA (C)  
JSM Protective, Inc., Port St. Lucie, FL (C)  
Toshiba America Energy Systems Corp., West Allis, WI (C, S)

**47400 Maintenance & Repair Services**

- BM Bolt-Maintenance  
BB Bus Bar Insulating (Epoxy Coating)  
C Concrete  
CO Condenser  
CN Construction  
CR Control Rod Drives  
CT Cooling Towers  
CH Cranes & Hoists  
DG Diesel Generators  
E Electrical Equipment  
EJ Expansion Joints  
FP Freeze Plugging/Sealing (Pipe)  
F Fuel Assemblies  
FT Fuel Transfer Equipment  
G General  
HX Heat Exchangers  
HV HVAC Equipment  
H Hydraulic Equipment  
LC Leak Repair, Concrete  
LP Loose Parts Retrieval  
MS Mechanical Seals  
MO Motors, Electric  
OM Outage Management Services  
PS Penetration Seals  
PI Pipe Cleaning, Internal (Bio-Fouling)  
PR Pipe Repair & Replacement  
P Plant Life Management  
PL Pool Liner Inspection & Repair  
PT Post-Tensioning System Surveillance  
PA Power Apparatus  
PD Predictive Maintenance  
PC Protective Coatings  
PM Pump & Motor, Main Coolant  
PU Pump Inspection & Repair  
RM Radiation Measuring Devices & Systems  
RS Radiation Shielding  
RW Radiation-Shielding Windows  
R Reactor  
RI Reactor Internals  
RF Refueling Equipment  
RC Regulatory Compliance Support (Maintenance Rule)  
RE Remote Inspection/Repair  
RA Rotating Machinery Alignment  
RO Rotating Machinery, Vibration Monitoring (Predictive)  
SC Screens, Traveling  
ST Seal Table/Flux Thimbles  
SS Security Systems, Anti-Intrusion  
S Snubbers  
SF Spent-Fuel Racks  
SN Stud/Nut Removal  
TC Tank Cleaning, Fuel Storage

- TR Trash Racks  
TS Tubesheet, Epoxy Cladding  
TG Turbine-Generator  
U Underwater Repairs  
VA Valve Actuators  
VR Valve Repair, Recertification  
VO Valve Testing, Off-Line  
VT Valve Testing, On-Line  
WI Water Intake Cavity Cleaning (Bio-Fouling)

- Adam Brown Consulting, Inc., Cary, IL (OM, PS)  
Advanced Consulting Group, Inc., Chicago, IL (R, RI, RE, SN, U)  
AECON-WACHS, (U.S. Div. of Aecon Nuclear), Jackson, SC (BM, CO, CN, CT, CH, DG, E, EJ, FP, F, FT, G, HX, HV, H, L, C, LP, MS, MO, OM, PS, PI, PR, P, PL, PT, PA, PD, PC, PM, PU, SC, SF, SN, TC, TR, VR)
- ◆ Allied Power, Baton Rouge, LA (BM, BB, C, CO, CN, CR, CT, CH, DG, E, EJ, FP, F, FT, G, HX, HV, H, L, C, LP, MS, MO, OM, PS, PI, PR, P, PL, PT, PA, PC, PM, PU, RM, RS, RW, R, RI, RF, RC, RE, RA, RO, SC, ST, SS, S, SE, SN, TC, TR, TS, TG, U, VA, VR, VO, VT, WI)
- ANTECH Corp., Arvada, CO (RM)  
Aptim, Baton Rouge, LA (CO, CN, G, HX, MS, PR, R, TS, TG, VA, VR, VO, VT)  
ASI Marine, (ASI Group Ltd.), Orchard Park, NY (FT, PI, PR, TC, U, WI)  
ATS Industrial Automation, Inc. - Nuclear (UK), Blaby, Leicester, United Kingdom (BM, FP, FT, RS, RE, SN)  
ATS Industrial Automation, Inc. Nuclear (Canada), Cambridge, Ontario, Canada (BM, FP, FT, RS, RE, SN)
- ◆ AVANTech, LLC, Columbia, SC (TC)  
Bakelite Synthetics, Atlanta, GA (PC)  
Baker Concrete Construction, Inc., Houston, TX (CN)
- ◆ Barnhart Nuclear Services, Fairhope, AL (CH)  
Basic E, Inc., Charlotte, VT (E, VA)  
Beaudrey American Services, Loveland, CO (CO, HX, SC, TR)
- ◆ Bechtel, (Bechtel Power), (Bechtel Nuclear, Security & Environmental), (Bechtel National), Reston, VA (CN)  
Berthold Technologies USA LLC, Oak Ridge, TN (RM)  
Bertin Technologies, France (RM)  
BHI Energy - now Westinghouse, See listing for Westinghouse Electric Co., Cranberry Township, PA (BM, CN, DG, E, EJ, G, HX, H, LC, OM, PS, PI, PR, P, PD, PC, PM, PU, RM, R, RF, RC, RE, RA, RO, SS, TG, VA, VR, VO, VT)  
Bilfinger Noell GmbH, (Dept. BEV), Wuerzburg, Germany (CH, H, RS, RW)  
Black & Veatch, Overland Park, KS (CN, DG, E, G, HX, HV, P, RC, TG)  
Bureau Veritas Inspection and Insurance Co., (previously OneCIS Inspection and Insurance Co.), Lynn, MA (RC, VR)  
BWX Technologies, Inc., Lynchburg, VA (BM, CO, DG, F, FT, G, HX, LP, MS, OM, PR, P, R, RI, RF, RE, SF, SN, VA, VR, VO)  
Carolina Fabricators, West Columbia, SC (S, SF)  
CBS Nuclear Services, Inc., Matthews, NC (E)  
Corrosion Control Services, Inc., Davenport, IA (OM)  
Cortec Corp., Saint Paul, MN (C, PC)
- ◆ Curtiss-Wright EST Group, Hatfield, PA (CO, HX)
- ◆ Curtiss-Wright Nuclear Division, Brea, CA (BM, CO, CR, CT, CH, DG, E, EJ, FT, HX, HV, H, LP, MS, MO, OM, PS, P, PA, PM, PU, RS, RF, RC, RE, RO, ST, S, SF, SN, VA, VR)  
Curtiss-Wright Nuclear Division, Enertech, Brea, CA (EJ, HX, HV, H, MS, PU, S)  
Curtiss-Wright Nuclear Division, Nova, Middleburg Heights, OH (BM, RF)  
Curtiss-Wright Nuclear Division, QualTech NP, Cincinnati, OH (CO, CT, CH, DG, E, HV, LP, MS, MO, OM, PS, P, PA, PM, PU, RS, RC, RE, RO, ST, S, VA, VR)  
Curtiss-Wright Nuclear Division, Scientech, Idaho Falls, ID (BM, CR, CH, FT, MO, OM, PS, RF, RC, RE, SF, SN)  
Cutting Technologies (CTI), Gloucester City, NJ (C, CN)
- ◆ Dominion Engineering, Inc., Reston, VA (PI, PC)



# Empowering the people who power the world

Allied Power is a diversified power plant maintenance provider.



## Maintenance

Life cycle services to maximize efficiency and safety



## Staff Augmentation

Professional, technical, and administrative staffing



## Major Modifications & Projects

Project management, project controls, and professional, technical, and craft support



## Outage Services

Professional, technical, and craft support during outages

- Dufrane Nuclear Shielding Inc., (Dufrane Nuclear Inc.), Winsted, CT (C, CN, G, RS, RW, TR)
- E.H. Wachs, (A Div. of ITW), Lincolnshire, IL (EJ, HX, H, PR, VA)
- E.S. Fox Limited, Niagara Falls, Ontario, Canada (BM, CN, CT, CH, HX, HV, MS, PR, R, RA, SF)
- Electrical Builders Inc. (EBI), St. Cloud, MN (BB, CN, E, EJ, PA, PD)
- Electro Static Technology, Mechanic Falls, ME (MS, PM)
- ◆Element Nuclear (NTS Labs), (Nuclear Engineering & Test Services), Huntsville, AL (S, VR, VO)
- Energy Steel, Rochester Hills, MI (HX)
- Engineered Rigging, Russellville, AR (PT)
- Environmental Restoration Group, Inc., Albuquerque, NM (RM)
- ◆EXCEL Services Corporation, Rockville, MD (RC)
- ◆Framatome Inc., (North American Headquarters), Lynchburg, VA (BM, CO, CR, CT, DG, E, F, FT, G, HX, H, LC, LP, MS, MO, OM, PS, PR, P, PL, PM, PU, RM, R, RI, RF, RC, RE, RA, RO, SC, ST, SE, SN, TC, TS, U, VA, VR, VO, VT)
- Fuel Tank Maintenance Co., LLC, Cookeville, TN (C, CN, CT, DG, EJ, G, HV, LC, PI, PR, PL, PC, TC, TG)
- FuseRing Inc., London, Ontario, Canada (F, PR)
- GE Hitachi Nuclear Energy, Wilmington, NC (CT, E, F, MO, OM, RM, R, RI, RF, RE, SF, U)
- GEM Technologies, Inc., Knoxville, TN (CN, G)
- General Atomics Electromagnetic Systems, San Diego, CA (RM)
- General Magnaplate Corp., Arlington, TX (PC)
- Goodway Technologies, Stamford, CT (CO, CT, HX, HV, PI)
- GSE Solutions, (GSE Systems), Columbia, MD (S)
- Health Physics Instruments, (Div. of Far West Technology), Goleta, CA (RM)
- Heat Exchanger Products Corp. (HEPCO), Hingham, MA (CO, HX, MS)
- Heatric Division of Meggitt (UK) Ltd., Poole, Dorset, United Kingdom (HX)
- Hennigan Engineering LLC, Hingham, MA (CO, HX, PI, TC, WI)
- ◆Holtec International, Camden, NJ (CO, HX, SF)
- Hopewell Designs, Inc., Alpharetta, GA (RS)
- Hot Cell Services Corp., (HCS Corp.), Kent, WA (RS, RW)
- Hydro, Inc., (HydroAire Services Division), Chicago, IL (PM, PU, RA, RO)
- In-Place Machining Company, LLC, Blue Ash, OH (C, U)
- Integra Services Technologies Inc., Sarnia, Ontario, Canada (BM, H)
- ISO-PACIFIC Remediation Technologies, Inc., Richland, WA (RM)
- James Fisher Technologies, Loveland, CO (RE, U)
- JNT Technical Services Inc., Little Ferry, NJ (CO, HX)
- K-Tek International Inc., Wilsonville, OR (VR, VO, VT)
- KCI Engineering Consultants, Downers Grove, IL (PD)
- Kinectrics Inc., Toronto, Ontario, Canada (C, E, LC, MO, OM, PI, P, PU, RS, RC, RO, SC, VO, VT)
- Konecranes Nuclear Equipment & Services LLC, (Formerly Morris Material Handling / P&H), New Berlin, WI (FT, RF)
- KSB, Inc., Henrico, VA (MS, PM, PU, RA)
- M&D Co., Ltd., Seoul, Korea (The Republic of) (PD)
- MarShield Radiation Shielding, (Div. of Marswell Metal Industries Ltd.), Burlington, Ontario, Canada (RS, RW)
- Master-Lee Energy Services, Latrobe, PA (F, FT, HX, LP, PI, PC, PM, R, RI, RF, ST, SE, SN, TC, ST)
- Master-Lee Engineered Products Inc., Latrobe, PA (HX, PM, R, RI, RF, ST, U)
- Mechanical Solutions, Inc., Whippany, NJ (RO)
- Mirion Technologies (Canberra) Inc., Meriden, CT (RM)
- ◆Mirion Technologies (IST) Corp., (Sensing Systems Div.), Horseheads, NY (MS, PS)
- Mirion Technologies, Inc., (Sensing Systems Div.), Atlanta, GA (MS, PS, RM)
- Mitsubishi Nuclear Energy Systems, Inc., (A Sub. of Mitsubishi Heavy Industries, Ltd.), Charlotte, NC (BM, BB, C, CO, CN, CR, CT, CH, DG, E, EJ, FP, F, FT, G, HX, HV, H, LC, LP, MS, MO, OM, PS, PI, PR, P, PL, PT, PA, PC, PM, PU, RM, RS, RW, R, RI, RF, RC, RE, RA, RO, SC, ST, SS, S, SE, SN, TC, TR, TS, TG, U, VA, VR, VO, VT, WI)
- NETCo, Windsor, ME (SS)
- Newark Wire Cloth Co., Cedar Grove, NJ (SC)
- North Wind Group, Idaho Falls, ID (CT, G)
- Nuclear Energy Components Ltd, Hope Valley, Derbyshire, United Kingdom (FT, G, RF, S, SF)
- NuclearN, Phoenix, AZ (OM, P, PD, RC)
- ◆NUCON International, Inc., Columbus, OH (HV)
- NuVision-HWM, (Wälischmiller Engineering), Pittsburgh, PA (RE)
- Pajarito Scientific Corp., Santa Fe, NM (RS)
- PAR Systems, LLC, Saint Paul, MN (CH, FT, RF, RE, SF, TC)
- ◆Paragon Energy Solutions, (Paragon), Fort Worth, TX (CO, E, HX, HV, MO, PM, PU, RM, VA, VR)
- Perma-Fix Environmental Services, Inc., Oak Ridge, TN (OM, RM, RS, RW, R, RC)
- ◆Petersen Inc. (A Precinmac Company), Ogden, UT (CN)
- Pioneer Motor Bearing Co., Kings Mountain, NC (MO, RA, RO)
- Piping Technology & Products, Inc., Houston, TX (CO, EJ, HX, PS)
- Plastocor, Inc., Hingham, MA (CO, EJ, HX, PC, TS)
- PMT Nuclear, Woodridge, IL (EJ, HX, HV, VA)
- Power Services Group, (Power Plant Services, Orbital Energy Services, Airco, Turbine Generator Maintenance), Cape Coral, FL (OM, PA, RA, TG, VR)
- ◆Precision Custom Components, LLC., (DC Fabricators), York, PA (SF)
- ◆Preferred Engineering Corp., (Sub. of Preferred Utilities Mfg. Corp.), Danbury, CT (FP, FT, LP, MS, RS, RF)
- Premier Technology, Inc., Blackfoot, ID (HX, HV, PR, PC, RS, RW, SF)
- PROTEM USA LLC, Evergreen, CO (DG, H, LP, MS, OM, PS)
- PTP Spent Fuel Services, LLC, Grand Island, NY (FT, SF)
- Radiation Protection Systems, (by Alpha Safety), Groton, CT (RS)
- ◆Radiation Safety & Control Services, Inc., Seabrook, NH (RM)
- REEL COH Inc., Canada (CH, RF)
- Republic Services, Livonia, MI (TC)
- Rexon Components, Inc., Beachwood, OH (RM)
- Rich Industries Inc., New Philadelphia, OH (RS)
- Robatel Technologies, LLC, Roanoke, VA (RS, RW, R, RI, RF, RE, SF)
- Sarens Nuclear & Industrial Services LLC, (Sarens), Houston, TX (CN, CH, HX, R, RI, SF, TG)
- Schulz Electric, Timken Power Systems, East Haven, CT (CH, DG, E, MO, PA, RA, RO)
- SERCO USA, Evergreen, CO (BM, CN, CR, HX, LP, MS, PS, PR, PU, R, RI, RE, SN, TS, TG, U, VR)
- SIET, Piacenza, Italy (VO, VT)
- SKODAJS a.s., Plzen, Bolevec, Czech Republic (The) (CR, E, R, RI, SF)
- ◆SSM Industries, Inc., (Nuclear Div.), Pittsburgh, PA (HV)
- Sulzer Management Ltd., (Sulzer Pumps (Canada) Inc.), Burnaby, British Columbia, Canada (MO, PU, TG)
- Teledyne Brown Engineering, Inc., Huntsville, AL (VO, VT)
- The Delphi Groupe, Inc., Austin, TX (G, OM, RC)
- The Merrick Group, Inc., West Hazleton, PA (CO, CT, EJ, G, HX, PI, PR, PC, ST, SN, TS, VA, VR)
- ◆Thermal Engineering International (TEI), Cerritos, CA (CO, HX)
- Thorburn Flex Inc., Pointe-Claire, Quebec, Canada (EJ)
- Toshiba America Energy Systems Corp., West Allis, WI (CO, CR, CT, DG, E, G, HX, H, LP, MS, MO, OM, PR, P, PL, PD, PM, PU, RM, R, RI, RF, RE, RA, RO, S, SE, TG, U, VA, VR, VO, VT)
- Transco Products Inc., Streator, IL (RS)
- Tyne USA Inc., Jacksonville, FL (RM, R)
- ◆Ultra Energy, (Weed Instrument), Round Rock, TX (P)
- ◆Underwater Construction Corp., (Underwater Construction Corp. UK Ltd.), Essex, CT (BM, FT, G, LP, PL, PC, R, RF, SC, SF, TR, U)
- ◆Valcor Engineering Corp., (Valcor Nuclear Div.), Springfield, NJ (VA)
- Westinghouse Electric Co. LLC, Cranberry Township, PA (BM, CO, CN, CR, CH, DG, E, EJ, F, FT, G, HX, H, LC, LP, MS, MO, OM, PS, PI, PR, P, PA, PD, PC, PM, PU, RM, RS, R, RI, RF, RC, RE, RA, RO, ST, SS, SE, SN, TG, U, VA, VR, VO, VT)
- ◆Westinghouse Electric Company LLC, (Westinghouse Parts Business), New Stanton, PA (CR, DG, E, MO, PM, RA, VA, VR, VO, VT)

## 47600 Manipulators, Remote

- Advanced Consulting Group, Inc., Chicago, IL
- ARES Security Corp., Vienna, VA
- ATS Industrial Automation, Inc. - Nuclear (UK), Blaby, Leicester, United Kingdom
- ATS Industrial Automation, Inc. Nuclear (Canada), Cambridge, Ontario, Canada
- Bilfinger Noell GmbH, (Dept. BEV), Wuerzburg, Germany
- Brokk AB, Skelleftea, Sweden
- ◆Brokk Inc., (Sub. of Brokk-Sweden), (Nuclear Div.), Santa Fe, NM
- BWX Technologies, Inc., Lynchburg, VA
- Central Research Laboratories, Red Wing, MN
- Encorus Group, Springville, NY
- ◆Framatome Inc., (North American Headquarters), Lynchburg, VA
- GE Hitachi Nuclear Energy, Wilmington, NC
- James Fisher Technologies, Loveland, CO
- Master-Lee Engineered Products Inc., Latrobe, PA
- Merrick & Company, Greenwood Village, CO
- Nuclear Energy Components Ltd, Hope Valley, Derbyshire, United Kingdom
- NuVision-HWM, (Wälischmiller Engineering), Pittsburgh, PA
- PAR Systems, LLC, Saint Paul, MN
- Radium Inc., Waynesboro, VA
- Robatel Technologies, LLC, Roanoke, VA
- Tru-Motion Products, LLC, Cheyenne, WY
- ◆Underwater Construction Corp., (Underwater Construction Corp. UK Ltd.), Essex, CT
- Veolia Nuclear Solutions - Federal Services, Piketon, OH
- Wälischmiller Engineering GmbH, Markdorf, Baden-Wuerttemberg, Germany

## 47620 Mapping Services

- A Automated
- C Conventional
- Merrick & Company, Greenwood Village, CO (A, C)
- ◆Radiation Safety & Control Services, Inc., Seabrook, NH (A)

## 47630 Markers, Identification

- ◆Alphasource, Inc., Philadelphia, PA
- Coastal Network, Inc, Charlottesville, VA
- ◆Frham Safety Products, Inc., Rock Hill, SC
- JSM Protective, Inc., Port St. Lucie, FL
- Scientific Sales, Inc., Oak Ridge, TN
- Tech Products, Inc., Staten Island, NY

## 47650 Markers, Pen, for Fabrication

- ◆Alphasource, Inc., Philadelphia, PA
- Scientific Sales, Inc., Oak Ridge, TN

## 47670 Markers, Pipe

- ◆Alphasource, Inc., Philadelphia, PA
- Coastal Network, Inc, Charlottesville, VA
- ◆Frham Safety Products, Inc., Rock Hill, SC
- JSM Protective, Inc., Port St. Lucie, FL
- ◆Reef Industries, Inc., (Griffolyon, Div. of Reef Industries, Inc.), Houston, TX
- Scientific Sales, Inc., Oak Ridge, TN
- Tech Products, Inc., Staten Island, NY

## 47900 Mass Spectrometers

- Centronic Ltd., Surrey, United Kingdom
- Scientific Sales, Inc., Oak Ridge, TN

◆ Denotes advertiser—see Index to Advertisers on pages 8–14

#### 48050 Materials Handling Equipment

- A Automated  
C Conventional  
CU Custom  
EP Explosion-proof
- ATS Industrial Automation, Inc. - Nuclear (UK), Blaby, Leicester, United Kingdom (A, C, CU, EP)  
ATS Industrial Automation, Inc. Nuclear (Canada), Cambridge, Ontario, Canada (A, C, CU, EP)  
Baker Industries, a Lincoln Electric Company, Macomb, MI (A, C, CU, EP)  
Bilfinger Noell GmbH, (Dept. BEV), Wuerzburg, Germany (CU)
- ◆ Brokk Inc., (Sub. of Brokk-Sweden), (Nuclear Div.), Santa Fe, NM (A, CU)  
Central Research Laboratories, Red Wing, MN (CU)  
Engineered Rigging, Russellville, AR (C, CU)
- ◆ Framatome Inc., (North American Headquarters), Lynchburg, VA (A, C, CU)  
Hot Cell Services Corp., (HCS Corp.), Kent, WA (C, CU)  
James Fisher Technologies, Loveland, CO (A, C, CU, EP)  
PAR Systems, LLC, Saint Paul, MN (A, C, CU, EP)
- ◆ Petersen Inc. (A Precinmac Company), Ogden, UT (CU)  
PROTEM USA LLC, Evergreen, CO (CU)  
REEL COH Inc., Canada (A, C, CU, EP)  
River Technologies, LLC, Forest, VA (EP)  
Robatel Technologies, LLC, Roanoke, VA (A, C, CU, EP)  
Rousselet-Robatel, Pittsfield, MA (EP)  
S&G Enterprises, Inc., Germantown, WI (EP)

#### 48300 Mechanical Control Devices

- ◆ DuBose National Energy Services, Inc., Clinton, NC  
◆ Framatome Inc., (North American Headquarters), Lynchburg, VA  
James Fisher Technologies, Loveland, CO  
◆ Preferred Engineering Corp., (Sub. of Preferred Utilities Mfg. Corp.), Danbury, CT

#### 48950 Metal Cladding Services

- ◆ DuBose National Energy Services, Inc., Clinton, NC  
E.S. Fox Limited, Niagara Falls, Ontario, Canada  
Lights Camera Action, LLC, Gilbert, AZ  
◆ Wagstaff Applied Technologies, Spokane, WA

#### 49000 Metal Components & Structures

- CA Castings, Aluminum  
CI Castings, Investment  
CL Castings, Lead  
LW Castings, Lost Wax (Cire Perdue)  
CP Castings, Precision  
SM Castings, Sand-Molded  
CS Castings, Steel & Alloy Steel  
F Fabrications  
FO Forgings  
L Laminations  
PF Pressure-Formed  
RF Roll-Formed, Custom
- Baker Industries, a Lincoln Electric Company, Macomb, MI (CA, CI, CL, LW, CP, SM, CS, F, FO, L, PF, RF)  
Camfil USA, Inc., Washington, NC (F)  
Carolina Fabricators, West Columbia, SC (CA, CI, CP, SM, CS, F, FO, PF, RF)  
CELSA Huta Ostrowiec, (Forge Div.), Ostrowiec Sw., Poland (FO)  
Consolidated Power Supply, (Div. of Consolidated Pipe & Supply Co., Inc.), Birmingham, AL (CA, CI, CL, LW, CP, SM, CS, F, FO, L, PF, RF)  
Container Technologies Industries, LLC, Helenwood, TN (F)  
Cross Manufacturing Co. (1938) Ltd., Bath, United Kingdom (RF)
- ◆ Curtiss-Wright Nuclear Division, Brea, CA (F)  
Curtiss-Wright Nuclear Division, QualTech NP, Cincinnati, OH (F)
- ◆ DuBose National Energy Services, Inc., Clinton, NC (CA, CS, F, FO, L, PF, RF)  
Dufrane Nuclear Shielding Inc., (Dufrane Nuclear Inc.), Winsted, CT (F)

- E.S. Fox Limited, Niagara Falls, Ontario, Canada (F, RF)  
Electrical Builders Inc. (EBI), St. Cloud, MN (F, L, RF)  
Energy Steel, Rochester Hills, MI (F)  
Engineered Rigging, Russellville, AR (F)
- ◆ Framatome Inc., (North American Headquarters), Lynchburg, VA (F, FO, RF)  
GE Hitachi Nuclear Energy, Wilmington, NC (F)  
Glidewell Specialties Foundry Co., Calera, AL (SM)  
Hopewell Designs, Inc., Alpharetta, GA (CL)
- ◆ I.C.E. Service Group, Inc., Moon Township, PA (F)  
In-Place Machining Company, LLC, Blue Ash, OH (F)
- ◆ James C. White Company, Inc., Greenville, SC (F, RF)  
Joseph Oat Corp., Camden, NJ (F, RF)  
Lincoln Structural Solutions, Louisville, NE (CS, F, RF)
- ◆ Major Tool & Machine, (A Precinmac Company), Indianapolis, IN (F, PF, RF)  
MarShield Radiation Shielding, (Div. of Marswell Metal Industries Ltd.), Burlington, Ontario, Canada (CL)  
Newark Wire Cloth Co., Cedar Grove, NJ (F)  
Nuclear Energy Components Ltd, Hope Valley, Derbyshire, United Kingdom (SM, F)  
NuSource LLC, Alexandria, VA (F, FO, PF, RF)
- ◆ Paragon Energy Solutions, (Paragon), Fort Worth, TX (CI, LW, CP, SM, CS, F)  
Patriot Forge Co., Brantford, Ontario, Canada (FO)  
Paxton & Vierling Steel, Carter Lake, IA (CP, SM, CS, F)
- ◆ Petersen Inc. (A Precinmac Company), Ogden, UT (F, PF, RF)  
Piping Technology & Products, Inc., Houston, TX (F)  
PMT Nuclear, Woodridge, IL (CA, CI, LW, CP, SM, CS, F, FO, RF)
- ◆ Precision Custom Components, LLC., (DC Fabricators), York, PA (F)  
Robatel Technologies, LLC, Roanoke, VA (F)  
Schulz Electric, Timken Power Systems, East Haven, CT (F, L)
- ◆ SSM Industries, Inc., (Nuclear Div.), Pittsburgh, PA (F)  
Teledyne Brown Engineering, Inc., Huntsville, AL (F)  
Tioga Pipe, Philadelphia, PA (F, FO)  
Toshiba America Energy Systems Corp., West Allis, WI (SM, CS, F, FO)  
Tri Nuclear Corp., Troy, NY (F)  
TW Metals - Nuclear Materials Solutions, Linden, MI (CA, CI, LW, CP, SM, CS, F, FO)
- ◆ Wagstaff Applied Technologies, Spokane, WA (F, RF)  
Westinghouse Electric Co. LLC, Cranberry Township, PA (F, FO, RF)

#### 49700 Metalizing

- BHI Energy - now Westinghouse, See listing for Westinghouse Electric Co., Cranberry Township, PA  
General Magnaplate Corp., Arlington, TX  
◆ Precision Custom Components, LLC., (DC Fabricators), York, PA  
Schulz Electric, Timken Power Systems, East Haven, CT  
Westinghouse Electric Co. LLC, Cranberry Township, PA

#### 50000 Metallographic Equipment

- GE Hitachi Nuclear Energy, Wilmington, NC  
Toshiba America Energy Systems Corp., West Allis, WI

#### 50250 Metals, Lead

- B Brick  
FS Fabricated Specialties  
LW Lead Wool Blankets  
P Plate  
SH Sheet  
ST Shot
- Baker Industries, a Lincoln Electric Company, Macomb, MI (F)  
Carolina Fabricators, West Columbia, SC (FS, P, SH)

- Consolidated Power Supply, (Div. of Consolidated Pipe & Supply Co., Inc.), Birmingham, AL (B, FS, LW, P, SH, ST)
- ◆ DuBose National Energy Services, Inc., Clinton, NC (FS, P, SH)  
Hopewell Designs, Inc., Alpharetta, GA (FS)
- ◆ I.C.E. Service Group, Inc., Moon Township, PA (FS)
- ◆ James C. White Company, Inc., Greenville, SC (FS, SH)  
Lancs Industries, Albuquerque, NM (B, FS, LW, P, SH, ST)  
MarShield Radiation Shielding, (Div. of Marswell Metal Industries Ltd.), Burlington, Ontario, Canada (B, FS, LW, P, SH, ST)  
Mohawk Safety, Inc., Manchester, CT (B, P, SH, ST)  
NSSI/Recovery Services Inc., Houston, TX (B)
- ◆ Petersen Inc. (A Precinmac Company), Ogden, UT (FS)  
Premier Technology, Inc., Blackfoot, ID (FS, LW, P, SH, ST)  
Radiation Protection Systems, (by Alpha Safety), Groton, CT (FS)  
Robatel Technologies, LLC, Roanoke, VA (B, FS, LW, P, SH, ST)  
J. L. Shepherd & Assoc., San Fernando, CA (FS)  
Tri Nuclear Corp., Troy, NY (FS)  
UCC Industries International Inc., Pickering, Ontario, Canada (FS)
- ◆ Wagstaff Applied Technologies, Spokane, WA (FS)

#### 50300 Metals, Other

- AC Alloys & Compounds  
AL Aluminum  
C Clad  
CO Copper  
HF Hafnium  
LI Lithium  
MG Magnesium  
MO Molybdenum  
NI Nickel & Nickel-Base Alloys  
NB Niobium  
TA Tantalum  
TE Tellurium  
TI Titanium  
U Uranium Metal  
VM Vacuum-Melted  
ZR Zirconium
- Battery Lane LLC, Carson City, NV (NB, TI)  
C.J. Enterprises, (Div. of C.J. Instruments, Inc.), Tarzana, CA (AL)  
Carolina Fabricators, West Columbia, SC (AC, AL, CO, MO, NI, TA, TI, VM, ZR)  
Consolidated Power Supply, (Div. of Consolidated Pipe & Supply Co., Inc.), Birmingham, AL (AC, AL, C, CO, HF, LI, MG, MO, NI, NB, TA, TE, TI, U, VM, ZR)
- ◆ Curtiss-Wright Nuclear Division, Brea, CA (AC, AL, C, CO, NI, TI, ZR)  
Curtiss-Wright Nuclear Division, Nova, Middleburg Heights, OH (AC, AL, C, CO, NI, TI, ZR)
- ◆ DuBose National Energy Services, Inc., Clinton, NC (AL, CO, NI, TI)  
Electrical Builders Inc. (EBI), St. Cloud, MN (AL, CO)  
Joseph Oat Corp., Camden, NJ (AC, C, CO, NI, TI, ZR)  
Lights Camera Action, LLC, Gilbert, AZ (AL, C)  
PMT Nuclear, Woodridge, IL (AC, AL, C, MO, NI)  
Rexon Components, Inc., Beachwood, OH (AL, CO, TI)  
TW Metals - Nuclear Materials Solutions, Linden, MI (AC, AL, C, CO, HF, MG, MO, NI, TI, VM, ZR)  
UxC, LLC, Roswell, GA (ZR)  
Westinghouse Electric Co. LLC, Cranberry Township, PA (C, HF, ZR)
- ◆ Westinghouse Electric Company LLC, (Westinghouse Parts Business), New Stanton, PA (AC, AL, C, CO, HF, LI, MG, MO, NI, NB, TA, TE, TI, U, VM, ZR)

#### 50350 Metals, Steel

- BS Boron Stainless  
C Carbon

CL Clad  
 CC Controlled-Chemistry Heat Melts  
 F Ferritic  
 S Stainless

Carolina Fabricators, West Columbia, SC (BS, C, CL, CC, F, S)  
 CELSA Huta Ostrowiec, (Forge Div.), Ostrowiec Sw., Poland (C)  
 Consolidated Power Supply, (Div. of Consolidated Pipe & Supply Co., Inc.), Birmingham, AL (BS, C, CL, CC, F, S)  
 ♦ Curtiss-Wright Nuclear Division, Brea, CA (BS, C, CL, F, S)  
 Curtiss-Wright Nuclear Division, Nova, Middleburg Heights, OH (BS, C, CL, F, S)  
 ♦ DuBose National Energy Services, Inc., Clinton, NC (BS, C, CL, CC, S)  
 GE Hitachi Nuclear Energy, Wilmington, NC (C, S)  
 Joseph Oat Corp., Camden, NJ (BS, C, CL, CC, F, S)  
 Lincoln Structural Solutions, Louisville, NE (BS, C, CC, F, S)  
 Paxton & Vierling Steel, Carter Lake, IA (C, S)  
 PMT Nuclear, Woodridge, IL (C, CL, S)  
 Tioga Pipe, Philadelphia, PA (BS, C, F, S)  
 Trust Manufacturing, LLC, Euclid, OH (F, S)  
 TW Metals - Nuclear Materials Solutions, Linden, MI (BS, C, CL, CC, F, S)  
 UCC Industries International Inc., Pickering, Ontario, Canada (C, S)  
 ♦ Westinghouse Electric Company LLC, (Westinghouse Parts Business), New Stanton, PA (BS, C, CL, CC, F, S)

### 51730 Meteorological Equipment

A Anemometers  
 B Barometers  
 H Humidity Sensors  
 P Precipitation Sensors  
 SR Solar Radiation Sensors  
 T Temperature Sensors

ENVINET GmbH, Munich/Haar, Germany (P)  
 ♦ RdF Corporation, Hudson, NH (T)  
 Remtech Inc., The Villages, FL (A, T)

### 51850 Meters

BC Boron Concentration  
 C Conductivity (Ion Concentration)  
 EF Energy Flow  
 F Flow  
 M Moisture  
 RA Reactor, Axial Offset  
 RP Reactor Period

Electrical Builders Inc. (EBI), St. Cloud, MN (M)  
 ♦ Framatome Inc., (North American Headquarters), Lynchburg, VA (BC, F, RA)  
 ♦ HI-Q Environmental Products Co., Inc., San Diego, CA (F)  
 Joseph Oat Corp., Camden, NJ (F)  
 ♦ LND, Inc., Oceanside, NY (M)  
 Martek Instruments, Inc., Raleigh, NC (C)  
 Mirion Technologies (IST Canada) ULC, (Formerly Mirion Technologies (IST Canada) Inc.), Cambridge, Ontario, Canada (BC, RP)  
 Mirion Technologies (MGPI H&B) GmbH, (Mirion Technologies), Munich, Germany (BC, F, RA, RP)  
 Mirion Technologies, Inc., (Sensing Systems Div.), Atlanta, GA (BC, RP)  
 ♦ OTEK Corp., Tucson, AZ (EF, F, M)  
 ♦ Paragon Energy Solutions, (Paragon), Fort Worth, TX (F, RA, RP)  
 ♦ RdF Corporation, Hudson, NH (EF)  
 Westinghouse Electric Co. LLC, Cranberry Township, PA (BC, F, RA)

### 53600 Microfilming

♦ OTEK Corp., Tucson, AZ

### 53950 Mockup Design & Fabrication

CR Control Room  
 E Equipment  
 LR Local & Remote Control Panels

AECON-WACHS, (U.S. Div. of Aecon Nuclear), Jackson, SC (E, LR)  
 Arkitek Scientific, Paso Robles, CA (CR, E)  
 ♦ AVANTech, LLC, Columbia, SC (LR)  
 Baker Industries, a Lincoln Electric Company, Macomb, MI (E)  
 Carolina Fabricators, West Columbia, SC (CR, E, LR)  
 ♦ Curtiss-Wright Nuclear Division, Brea, CA (CR, E)  
 Curtiss-Wright Nuclear Division, Scientech, Idaho Falls, ID (CR, E)  
 ♦ Element Nuclear (NTS Labs), (Nuclear Engineering & Test Services), Huntsville, AL (E)  
 Encorus Group, Springville, NY (CR, E, LR)  
 ♦ Framatome Inc., (North American Headquarters), Lynchburg, VA (CR, E)  
 GE Hitachi Nuclear Energy, Wilmington, NC (E)  
 GSE Solutions, (GSE Systems), Columbia, MD (CR, E, LR)  
 ISO-PACIFIC Remediation Technologies, Inc., Richland, WA (LR)  
 James Fisher Technologies, Loveland, CO (E)  
 MarShield Radiation Shielding, (Div. of Marswell Metal Industries Ltd.), Burlington, Ontario, Canada (CR, LR)  
 Merrick & Company, Greenwood Village, CO (E)  
 NuSource LLC, Alexandria, VA (E)  
 NuVision-HWM, (Wälischmiller Engineering), Pittsburgh, PA (CR, E, LR)  
 ♦ OTEK Corp., Tucson, AZ (CR)  
 PAR Systems, LLC, Saint Paul, MN (E)  
 ♦ Precision Custom Components, LLC., (DC Fabricators), York, PA (E)  
 ♦ Preferred Engineering Corp., (Sub. of Preferred Utilities Mfg. Corp.), Danbury, CT (E)  
 Premier Technology, Inc., Blackfoot, ID (E)  
 PROTEM USA LLC, Evergreen, CO (E)  
 ♦ Radiation Safety & Control Services, Inc., Seabrook, NH (E)  
 Radiological Solutions Inc., Rockdale, IL (E)  
 Siempelkamp NIS, Alzenau, Germany (E)  
 SLET, Piacenza, Italy (E)  
 TRAD - RayXpert, Labège cedex, France (CR, E, LR)  
 Veolia Nuclear Solutions - Federal Services, Piketon, OH (E, LR)  
 ♦ Wagstaff Applied Technologies, Spokane, WA (CR, E, LR)

### 54000 Model Making

ARES Security Corp., Vienna, VA  
 Baker Industries, a Lincoln Electric Company, Macomb, MI  
 Consolidated Power Supply, (Div. of Consolidated Pipe & Supply Co., Inc.), Birmingham, AL  
 ♦ Framatome Inc., (North American Headquarters), Lynchburg, VA  
 ♦ Preferred Engineering Corp., (Sub. of Preferred Utilities Mfg. Corp.), Danbury, CT

### 54300 Moisture Separators & Reheaters

AECON-WACHS, (U.S. Div. of Aecon Nuclear), Jackson, SC  
 Ellis & Watts Global Industries, Inc., (a sub. of Marmon, a Berkshire Hathaway company), Batavia, OH  
 Heatic Division of Meggitt (UK) Ltd., Poole, Dorset, United Kingdom  
 Mitsubishi Nuclear Energy Systems, Inc., (A Sub. of Mitsubishi Heavy Industries, Ltd.), Charlotte, NC  
 Powerfect Service, Inc., Brick, NJ  
 Sarens Nuclear & Industrial Services LLC, (Sarens), Houston, TX  
 ♦ Thermal Engineering International (TEi), Cerritos, CA  
 Toshiba America Energy Systems Corp., West Allis, WI  
 ♦ Westinghouse Electric Company LLC, (Westinghouse Parts Business), New Stanton, PA

### 54750 Monitors, Other Than Radiation

AI Air In-Leak  
 B Breathing  
 CC Cable Condition  
 CV Check Valve  
 C Chlorine  
 B Breathing Air Testing  
 CW Cooling Water System  
 CO Corrosion  
 FE Filter Efficiency  
 F Fuel Element (Ex-Reactor)  
 G Gas  
 HL Humidity, Integrated Leak Rate Test  
 IL In-Line Process  
 LP Loose Parts  
 MC Machinery Condition  
 N Noise  
 PP Plant Performance (Flow/Temperature)  
 RH Reactor Heat Recovery Level (Outage)  
 SW Service Water System  
 SG Steam Generator Leak Rate  
 T Temperature  
 V Vibration  
 WC Water Chemistry  
 W Weld

Aquasol Corp., North Tonawanda, NY (W)  
 Automation Products, Inc., (Dynatrol Div.), Houston, TX (IL)  
 ♦ AVANTech, LLC, Columbia, SC (SW, WC)  
 Bertin Technologies, France (G)  
 CM Technologies Corp., Coraopolis, PA (CC)  
 ♦ Curtiss-Wright Nuclear Division, Brea, CA (AI, CV, CO, T, V, WC)  
 Curtiss-Wright Nuclear Division, Enertech, Brea, CA (AI, CV, T, V)  
 Curtiss-Wright Nuclear Division, Scientech, Idaho Falls, ID (CO, WC)  
 ♦ Dominion Engineering, Inc., Reston, VA (F)  
 ♦ Element Nuclear (NTS Labs), (Nuclear Engineering & Test Services), Huntsville, AL (C)  
 FCI-Fluid Components International, San Marcos, CA (AI)  
 ♦ Framatome Inc., (North American Headquarters), Lynchburg, VA (CV, C, B, CW, F, IL, LP, MC, N, PP, SG, T, V, WC)  
 GE Hitachi Nuclear Energy, Wilmington, NC (F)  
 GLSEQ, LLC, Huntsville, AL (CC, G, IL, LP, N, PP, T, V)  
 JSM Protective, Inc., Port St. Lucie, FL (T)  
 KCI Engineering Consultants, Downers Grove, IL (CC)  
 Kinectrics Inc., Toronto, Ontario, Canada (CC, CO, PP, WC)  
 ♦ LND, Inc., Oceanside, NY (IL)  
 Martek Instruments, Inc., Raleigh, NC (IL, WC)  
 Mechanical Solutions, Inc., Whippany, NJ (V)  
 ♦ Mirion Technologies (IST) Corp., (Sensing Systems Div.), Horseheads, NY (F, LP, N, T)  
 Mirion Technologies, Inc., (Sensing Systems Div.), Atlanta, GA (F, LP, N, SG, T)  
 Nextteq International LLC, Tampa, FL (C, G)  
 ♦ NUCON International, Inc., Columbus, OH (AI, FE)  
 ♦ OTEK Corp., Tucson, AZ (B, CW, SG, T, V)  
 Radiation Pros, LLC, (dba Rad Pros), Englewood, CO (G)  
 Radiological Solutions Inc., Rockdale, IL (CO, WC)  
 ♦ RdF Corporation, Hudson, NH (T)  
 Scientific Sales, Inc., Oak Ridge, TN (B, G)  
 Sidus Solutions LLC, San Diego, CA (CW, SW)  
 Syscom Instruments S.A., Sainte-Croix, Switzerland (V)  
 Teledyne Brown Engineering, Inc., Huntsville, AL (G)  
 Temp-Pro Inc., Northampton, MA (T)  
 THERMOCOAX Inc., Alpharetta, GA (T)  
 THERMOCOAX SAS, Caligny, France (T)  
 Tyne USA Inc., Jacksonville, FL (AI, B, IL)  
 Westinghouse Electric Co. LLC, Cranberry Township, PA (LP, PP, RH, SG, T, V)



**55040 Monitors, Radiation, Area & Special-Purpose**

- AA Air, Alpha, Continuous
  - AP Air, Particulate
  - AF Automated Floor Survey System
  - B Bag
  - CW Conveyorized Waste
  - DB Drum/Barrel
  - FA Fixed-Area
  - F Floor Contamination
  - FC Food Contamination
  - GE Gas Effluent
  - G Gate
  - L Laundry
  - LE Liquid Effluent
  - M Microwave & RF Radiation
  - MA Mobile (Aircraft)
  - MV Mobile (Vehicular)
  - OS Outstations
  - P Perimeter
  - PL Pipe/Lumber
  - PS Portable Survey Meters
  - R Radon
  - S Scrap, Radioactive
  - SE Stack Effluent
  - T Tool
  - TR Tritium
  - TP Tritium, Portable
  - U Underwater
- 3D PLUS, (Detection Systems), Versailles, France (AF, B, DB, FA)
- Advantage Solutions, El Segundo, CA (AA, AP, AF, DB, FA, F, PS, R, SE, TR, TP, U)
- ANTECH Corp., Arvada, CO (B, CW, DB, L, OS, S)
- ARES Security Corp., Vienna, VA (MV, P)
- Aurum Technologies, Blackfoot, ID (PS)
- ◆AVANTech, LLC, Columbia, SC (LE)
- Berkeley Nucleonics Corp., San Rafael, CA (M)
- Berthold Technologies USA LLC, Oak Ridge, TN (AA, AP, DB, FA, F, FC, GE, L, MA, MV, PS, SE, TR)

- Bertin Technologies, France (AA, AP, AF, CW, DB, F, GE, G, L, LE, OS, P, PS, R, S, T, TR, TP, U)
- ◆Bot Engineering Ltd, Campbellville, Ontario, Canada (AA, AP, B, CW, DB, FA, F, GE, G, L, LE, P, PS, SE, T, TR, TP, U)
- CAEN SyS, (CAEN SpA), Viareggio, LU, Italy (AF, F, LE, PS)
- Coastal Network, Inc, Charlottesville, VA (AP, PS)
- Cutting Technologies (CTI), Gloucester City, NJ (F)
- Eastern Technologies, Inc., (OREX; PolyZolv), Ashford, AL (L)
- ◆EnergySolutions, Salt Lake City, UT (B, CW, DB, F, PS, S)
- ENVINET GmbH, Munich/Haar, Germany (AP, FA, MA, MV, OS, P, U)
- Environmental Restoration Group, Inc., Albuquerque, NM (AF, F, MA, MV, PS, R)
- ◆F&J SPECIALTY PRODUCTS, INC., Ocala, FL (AP, R)
- FabOhio, Inc., Uhrichsville, OH (B)
- FCI-Fluid Components International, San Marcos, CA (AP, GE, LE, SE)
- ◆Framatome Inc., (North American Headquarters), Lynchburg, VA (MV)
- Gamma Reality Inc., Richmond, CA (MA, MV)
- GE Hitachi Nuclear Energy, Wilmington, NC (GE, P, SE)
- General Atomics Electromagnetic Systems, San Diego, CA (AA, AP, FA, GE, LE, MV, P, R, SE, TR)
- GLSEQ, LLC, Huntsville, AL (PS)
- H3D, Inc., Ann Arbor, MI (FA, MA, MV, PS, S, U)
- Health Physics Instruments, (Div. of Far West Technology), Goleta, CA (PS)
- ◆HI-Q Environmental Products Co., Inc., San Diego, CA (AA, AP, F, GE, P, PS, R, SE, TR, TP)
- James Fisher Technologies, Loveland, CO (AA, AP, CW, DB, FA, G, S, T)
- JSM Protective, Inc., Port St. Lucie, FL (PS)
- Kinectrics Inc., Toronto, Ontario, Canada (AP, TR)
- LabLogic Systems, Inc., Chantilly, VA (PS)

- ◆LND, Inc., Oceanside, NY (AP, DB, FA, F, FC, GE, G, L, LE, P, PL, PS, R, S, SE, T, TR, TP, U)
- Ludlum Measurements, Inc., Sweetwater, TX (F, G, L, PS, S, TP, U)
- Mirion Technologies (Canberra) Inc., Meriden, CT (AA, AP, CW, DB, FC, GE, LE, MV, OS, P, PS, R, S, SE, T, TR, TP)
- Mirion Technologies (MGPI H&B) GmbH, (Mirion Technologies), Munich, Germany (AP, DB, FA, GE, LE, SE)
- Mirion Technologies (Premium Analyse) SAS, Norroy Le Veneur, France (GE, TR, TP)
- Mirion Technologies, Inc., (Sensing Systems Div.), Atlanta, GA (AF, B, F, GE, G, L, LE, MA, MV, P, PL, PS, R, S, SE, T, TR, U)
- Mound Technical Solutions, Inc., Miamisburg, OH (SE, TR, TP)
- ◆NUCON International, Inc., Columbus, OH (AP, GE, LE)
- ORTEC, Oak Ridge, TN (AP, B, CW, DB, FA, G, LE, MV, P, PL, PS, SE)
- Overhoff Technology Corp., (A Div. of US Nuclear Corp.), Milford, OH (AA, B, DB, FA, GE, LE, R, SE, T, TR, TP)
- Pajarito Scientific Corp., Santa Fe, NM (AF, B, CW, DB, FC, MA, MV, S, SE, U)
- ◆The Park Company, Pasco, WA (AA, AP)
- PHDS Co., Knoxville, TN (MA, MV)
- Power Generation Integrated, (PGICL), Etobicoke, Ontario, Canada (TR, TP)
- Pylon Electronics Inc., (Instrument Manufacturing Div.), Ottawa, Ontario, Canada (AA, AP, F, PS, R)
- ◆Radiation Safety & Control Services, Inc., Seabrook, NH (AA, AP, AF, FA, F, PS, R, TR)
- Radiological Solutions Inc., Rockdale, IL (PL, PS)
- ReNuke, Oak Ridge, TN (AA, AP, F, P, PS, R)
- Rexon Components, Inc., Beachwood, OH (AA, AP, FA, F, GE, G, P, R, S, TR, TP, U)
- Robatel Technologies, LLC, Roanoke, VA (AF, CW, DB)
- S.E. International, Inc., Summertown, TN (PS)
- Scientific Sales, Inc., Oak Ridge, TN (AA, AP)





*Providers of Engineered Systems in the Nuclear, Space & Terrestrial Sciences*

[www.bot.engineering](http://www.bot.engineering)  
[info@botcorp.com](mailto:info@botcorp.com)

**Celebrating over 40 years of excellence, innovation and experience as a global supplier of nuclear instrumentation systems.**

We are one of the only manufacturers of critical equipment used in the entire life cycle of nuclear facilities from startup to final decommissioning and spent fuel internment.

We guarantee our products do the job you bought them for and we always provide long-term support you can count on.

Some of the products we manufacture include:

- Hand held Alpha, Beta, Neutron, Gamma health physics meters and dosimeters
- Portable Instrumented work carts for radioactive work areas
- Fixed in-plant gamma, neutron, Tritium monitoring/ alarm systems
- Fixed and portable stack sampling systems, including - real time and passive PING, Tritium in air, C-14
- Stack sampling probe rake assemblies and shrouded nozzles
- Liquid effluent and duct monitors/alarm systems
- Reactor Safety system controls, modules and detectors
- Reactor Control system electronics

- Waste Drum and waste Bag Monitors
- Legacy Line - Drop in replacement systems and components for legacy equipment – control room, I&C, safety systems, stack/ effluent monitoring, area monitors and others
- Very high reliability hot swap I&C and reactor control power supply systems
- Satellite network based autonomous wide area radiation monitoring systems
- Multi Mega Rad dose tolerant fixed and portable gamma radiation monitors/detectors
- High sensitivity, high stability wide dynamic range lon chamber systems - sub fA to mA
- Nuclear Safeguards systems and spent fuel monitors





**716-304-7041**   
**905-876-4301** 

Staplex - Air Sampler Div., Brooklyn, NY (AP)  
 Technical Associates, (a Div. of US Nuclear Corp.), Canoga Park, CA (AA, AP, AF, B, CW, DB, FA, F, FC, GE, G, L, LE, MA, MV, P, PS, R, S, SE, T, TR, TP, U)  
 Toshiba America Energy Systems Corp., West Allis, WI (GE, G, L, LE, SE, TR)  
 Tyne USA Inc., Jacksonville, FL (AA, AP, FA, GE, LE, OS, P, SE, TR, TP)  
 ♦ Ultra Energy, (Weed Instrument), Round Rock, TX (AA, FA, GE, LE, SE)  
 UniTech Services Group Europe, (Sub. of UniTech Services Group USA), Coevorden, Netherlands (The) (B, L)  
 ♦ UniTech Services Group, Inc., (Div. of UniFirst Corp.), Longmeadow, MA (L, M, S)  
 US Nuclear Corp., (Technical Associates Sub.), (Overhoff Technology Corp. Sub.), Canoga Park, CA (AA, AP, B, CW, DB, FA, F, FC, GE, G, L, LE, MA, MV, P, PL, PS, R, S, SE, T, TR, TP, U)  
 Warrington, Inc., Pflugerville, TX (AA, PS, S)  
 Westinghouse Electric Co. LLC, Cranberry Township, PA (AP, GE, LE)

### 55060 Monitors, Radiation, Personnel

AL Audible Alarm (Electronic)  
 D Doorway  
 FB Film Badges, Films  
 HF Hand-and-Foot  
 PI Pocket Ion Chambers  
 TL Thermoluminescent Dosimeters (TLD)  
 WB Whole-Body  
 WM Whole-Body, Mobile  
 Advetage Solutions, El Segundo, CA (HF, PI, TL)  
 Aurum Technologies, Blackfoot, ID (AL, WM)  
 Berthold Technologies USA LLC, Oak Ridge, TN (AL, D, HF, WB)  
 Bertin Technologies, France (D, HF, WB)  
 ♦ Bot Engineering Ltd, Campbellville, Ontario, Canada (AL)  
 Coastal Network, Inc, Charlottesville, VA (PI)  
 DETEK, Temple Hills, MD (PI)  
 ENVINET GmbH, Munich/Haar, Germany (AL)  
 Environmental Restoration Group, Inc., Albuquerque, NM (D)  
 ♦ Framatome Inc., (North American Headquarters), Lynchburg, VA (WB)  
 General Atomics Electromagnetic Systems, San Diego, CA (AL)  
 ♦ HI-Q Environmental Products Co., Inc., San Diego, CA (HF, WB)  
 James Fisher Technologies, Loveland, CO (AL, D, HF, PI, WB, WM)  
 ♦ LND, Inc., Oceanside, NY (AL, D, HF, PI, WB)  
 Ludlum Measurements, Inc., Sweetwater, TX (D, HF, WB)  
 Mirion Technologies (Canberra) Inc., Meriden, CT (AL, HF, WB)  
 ORTEC, Oak Ridge, TN (D, HF, WB)  
 Radiation Pros, LLC, (dba Rad Pros), Englewood, CO (FB, TL, WB)  
 ♦ Radiation Safety & Control Services, Inc., Seabrook, NH (AL, FB, PI, TL)  
 ReNuke, Oak Ridge, TN (PI, TL)  
 Rexon Components, Inc., Beachwood, OH (D, HF, TL, WB)  
 S.E. International, Inc., Summertown, TN (PI)  
 Scientific Sales, Inc., Oak Ridge, TN (TL)  
 Technical Associates, (a Div. of US Nuclear Corp.), Canoga Park, CA (AL, D, HF, PI, WB)  
 Toshiba America Energy Systems Corp., West Allis, WI (AL, D, HF)  
 Tyne USA Inc., Jacksonville, FL (AL, D, PI, WB, WM)  
 ♦ UniTech Services Group, Inc., (Div. of UniFirst Corp.), Longmeadow, MA (AL)  
 US Nuclear Corp., (Technical Associates Sub.), (Overhoff Technology Corp. Sub.), Canoga Park, CA (AL, D, HF, PI, WB)  
 Warrington, Inc., Pflugerville, TX (AL)

### 55200 Mossbauer-Effect Equipment, Sources

♦ LND, Inc., Oceanside, NY  
 Mirion Technologies (Canberra) Inc., Meriden, CT

### 55300 Motors

E Electrical  
 H Hydraulic  
 L Linear  
 Centronic Ltd., Surrey, United Kingdom (E)  
 ♦ Curtiss-Wright Nuclear Division, Brea, CA (E)  
 Curtiss-Wright Nuclear Division, QualTech NP, Cincinnati, OH (E)  
 Ellis & Watts Global Industries, Inc., (a sub. of Marmon®, a Berkshire Hathaway company), Batavia, OH (E)  
 ♦ Framatome Inc., (North American Headquarters), Lynchburg, VA (E)  
 Hayward Tyler Inc., Colchester, VT (E)  
 Kinectrics Inc., Toronto, Ontario, Canada (E)  
 ♦ Paragon Energy Solutions, (Paragon), Fort Worth, TX (E)  
 Schulz Electric, Timken Power Systems, East Haven, CT (E, L)  
 ♦ SSM Industries, Inc., (Nuclear Div.), Pittsburgh, PA (E)  
 Toshiba America Energy Systems Corp., West Allis, WI (E)  
 Westinghouse Electric Co. LLC, Cranberry Township, PA (E)  
 ♦ Westinghouse Electric Company LLC, (Westinghouse Parts Business), New Stanton, PA (E, H, L)

### 55470 Multiplexing Systems

A Analog  
 D Digital  
 R Remote  
 ♦ Bot Engineering Ltd, Campbellville, Ontario, Canada (A, D)  
 ♦ Framatome Inc., (North American Headquarters), Lynchburg, VA (A, D, R)  
 GE Hitachi Nuclear Energy, Wilmington, NC (A, D, R)  
 ♦ OTEK Corp., Tucson, AZ (A, D)  
 ♦ Paragon Energy Solutions, (Paragon), Fort Worth, TX (A, D, R)  
 Technical Associates, (a Div. of US Nuclear Corp.), Canoga Park, CA (A, D, R)  
 Toshiba America Energy Systems Corp., West Allis, WI (A, D, R)

### 55490 Neutron Absorbers

BA Boric Acid  
 BC Boron Carbides  
 CE Boron Carbides, Enriched (B-10)  
 BN Boron, Natural  
 BE Boron, Enriched (B-10, B-11)  
 OB Other Boron Compounds  
 BP Burnable Poisons  
 C Cadmium  
 CS Cadmium Sulfide  
 E Encapsulated  
 GD Gadolinium  
 G Grain  
 IM In Matrixes  
 MM Metal Matrix Composites  
 MS Molded Shapes  
 P Pellets  
 PL Plates  
 3M Technical Ceramics, Inc., Quapaw, OK (BA, BC, CE, BN, BE, OB, BP, MM, P, PL)  
 Dufrane Nuclear Shielding Inc., (Dufrane Nuclear Inc.), Winsted, CT (BA, BC, BN, E, MS)  
 ♦ Framatome Inc., (North American Headquarters), Lynchburg, VA (BP, GD)  
 Free Form Fibers, Saratoga Springs, NY (BC, MM)  
 GE Hitachi Nuclear Energy, Wilmington, NC (BP, GD, P)  
 Hopewell Designs, Inc., Alpharetta, GA (IM, MS)  
 MarShield Radiation Shielding, (Div. of Marswell Metal Industries Ltd.), Burlington, Ontario, Canada (E, P)  
 MillenniTEK, LLC, Knoxville, TN (BC, CE, BN, BE, OB, BP, MM, P, PL)  
 ♦ NAC International Inc., Peachtree Corners, GA (MS)  
 Nuclear Shielding Supplies & Service, Tucson, AZ (BC)

Premier Technology, Inc., Blackfoot, ID (BC)  
 Robatel Technologies, LLC, Roanoke, VA (OB, E, IM, MM, MS, PL)  
 Roberts Engineering Services, Inc., Stuart, FL (C, PL)  
 THERMOCOAX Inc., Alpharetta, GA (BP)  
 THERMOCOAX SAS, Caligny, France (BP)  
 Westinghouse Electric Co. LLC, Cranberry Township, PA (BC, CE, BE, BP, C, GD, MS)

### 55500 Neutron Activation Analysis Services

Centronic Ltd., Surrey, United Kingdom  
 DW James Consulting, LLC, North Oaks, MN  
 ♦ Framatome Inc., (North American Headquarters), Lynchburg, VA  
 GE Hitachi Nuclear Energy, Wilmington, NC  
 ♦ Radiation Safety & Control Services, Inc., Seabrook, NH  
 TransWare Enterprises Inc., St. Louis, MO  
 ♦ WMG, Inc., Peekskill, NY

### 55550 Neutron Activation Flux Wires & Foils

AFO Research Inc., Vero Beach, FL  
 Centronic Ltd., Surrey, United Kingdom  
 ♦ Framatome Inc., (North American Headquarters), Lynchburg, VA

### 56400 Neutron Detectors, Reactor

XC Ex-Core  
 IC In-Core  
 SD Superheated Drop (Bubble) Detectors  
 Bertin Technologies, France (XC)  
 Centronic Ltd., Surrey, United Kingdom (XC, IC, SD)  
 CTR Technical Services, Inc., Manitou Springs, CO (IC)  
 ♦ Framatome Inc., (North American Headquarters), Lynchburg, VA (XC, IC)  
 GE Hitachi Nuclear Energy, Wilmington, NC (XC, IC)  
 ♦ LND, Inc., Oceanside, NY (XC, IC)  
 Mirion Technologies (Canberra) Inc., Meriden, CT (XC)  
 Mirion Technologies (IST Canada) ULC, (Formerly Mirion Technologies (IST Canada) Inc.), Cambridge, Ontario, Canada (XC, IC)  
 ♦ Mirion Technologies (IST) Corp., (Sensing Systems Div.), Horseheads, NY (XC, IC)  
 Mirion Technologies (MGPI H&B) GmbH, (Mirion Technologies), Munich, Germany (XC, IC)  
 Mirion Technologies, Inc., (Sensing Systems Div.), Atlanta, GA (XC, IC)  
 ♦ Paragon Energy Solutions, (Paragon), Fort Worth, TX (XC, IC)  
 ♦ Photonis, Brive la Gaillarde Cedex, France (XC, IC)  
 THERMOCOAX Inc., Alpharetta, GA (IC)  
 THERMOCOAX SAS, Caligny, France (IC)  
 Toshiba America Energy Systems Corp., West Allis, WI (IC)  
 ♦ Ultra Energy, (Weed Instrument), Round Rock, TX (XC, IC)  
 US Nuclear Corp., (Technical Associates Sub.), (Overhoff Technology Corp. Sub.), Canoga Park, CA (XC)  
 USERS Corp., Daejeon, Korea (The Republic of) (XC, IC)  
 Westinghouse Electric Co. LLC, Cranberry Township, PA (XC, IC)

### 56460 Neutron Howitzers

Centronic Ltd., Surrey, United Kingdom  
 J. L. Shepherd & Assoc., San Fernando, CA

### 56470 Neutron Spectrometers

Centronic Ltd., Surrey, United Kingdom  
 Mirion Technologies (Canberra) Inc., Meriden, CT  
 ORTEC, Oak Ridge, TN

### 56600 Nondestructive Testing

AC Acoustic Emission  
 EC Eddy Current

◆ Denotes advertiser—see Index to Advertisers on pages 8–14

E Equipment Sales  
 DP Dye Penetrant  
 FP Fluorescent Penetrant  
 FL Flux Leakage  
 GP Ground Penetrating Radar  
 I Infrared  
 MP Magnetic Particle  
 R Radiographic  
 RT Radiographic, Real-Time Imaging  
 RS Residual Stress  
 S Services  
 U Ultrasonic  
 UW Underwater

Baker Industries, a Lincoln Electric Company, Macomb, MI (AC, EC, DP, FP, FL, GP, I, MP, R, RT, RS, S, U, UW)

BWX Technologies, Inc., Lynchburg, VA (EC, DP, FP, FL, MP, S, U, UW)

Carolina Fabricators, West Columbia, SC (DP, MP, R, U)

Consolidated Power Supply, (Div. of Consolidated Pipe & Supply Co., Inc.), Birmingham, AL (DP, FP, MP, R, S, U)

◆ Curtiss-Wright Nuclear Division, Brea, CA (EC, E, DP, FP, I, MP, S, U)

Curtiss-Wright Nuclear Division, Anatec, Brea, CA (EC, DP, FP, MP, S, U)

Curtiss-Wright Nuclear Division, Enertech, Brea, CA (E, S)

Curtiss-Wright Nuclear Division, LMT, Hutchinson, MN (EC, DP, MP, U)

Curtiss-Wright Nuclear Division, QualTech NP, Cincinnati, OH (I)

Cutting Technologies (CTI), Gloucester City, NJ (GP)

DETEK, Temple Hills, MD (EC, E, DP, FP, FL, I, MP, R, S, U)

◆ DuBose National Energy Services, Inc., Clinton, NC (EC, DP, FP, MP, R, U)

E.S. Fox Limited, Niagara Falls, Ontario, Canada (DP, FP, MP, S, U)

Elcometer, Inc., Warren, MI (EC, U)

Electrical Builders Inc. (EBI), St. Cloud, MN (I, S)

◆ Element Nuclear (NTS Labs), (Nuclear Engineering & Test Services), Huntsville, AL (DP)

Evident Scientific, Inc., (Evident Corp.), Webster, TX (EC, U)

◆ Framatome Inc., (North American Headquarters), Lynchburg, VA (AC, EC, E, DP, FP, FL, MP, R, RT, RS, S, U, UW)

Fuel Tank Maintenance Co., LLC, Cookeville, TN (EC, DP, FP, FL, I, MP, R, RT, RS, S, U)

GE Hitachi Nuclear Energy, Wilmington, NC (EC, DP, R, S, U)

Glidewell Specialties Foundry Co., Calera, AL (DP, MP, U)

GLSEQ, LLC, Huntsville, AL (S)

H3D, Inc., Ann Arbor, MI (RT)

Hennigan Engineering LLC, Hingham, MA (U)



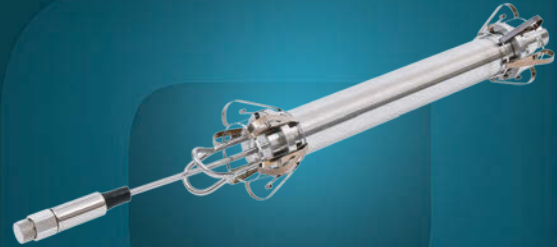

Hydro, Inc., (HydroAire Services Division), Chicago, IL (DP, MP, U)

## HIGH TEMPERATURE INSTRUMENTS FOR ADVANCED REACTORS



**PHOTONIS**  
EXOSENS GROUP



exosens.com | nuclearsales@exosens.com |    

# Neutron Detectors

We manufacture a complete family of Neutron Detectors for virtually every industrial nuclear and OEM application, including:

- Health Physics
- Analytical Instrumentation
- Environmental and Personnel Monitoring
- Industrial Gauging and Controls
- Power Plant Applications
- Medical Instrumentation
- Homeland Security Applications

Our exacting manufacturing procedures and strict, audited quality assurance policies meet ANSI/NCSS Z540.3-2006, MIL-PRF-1N, Appendix B of 10CFR50. An ISO 9001:2015 company.

**Call or e-mail for information.**

3230 Lawson Blvd · Oceanside, New York 11572  
 T: 516-678-6141 · F: 516-678-6704 · E: [INFO@LNDINC.COM](mailto:INFO@LNDINC.COM)

**He<sup>3</sup>-BF<sub>3</sub>  
Proportional Counters**

**Fission Chambers**

**Neutron Beam Monitors**

**Proton Recoil Counters**

**Neutron Ionization  
Chambers**

**WWW.LNDINC.COM**

**LND, INC.**

Since 1964

In-Place Machining Company, LLC, Blue Ash, OH (DP)  
 Integra Services Technologies Inc., Sarnia, Ontario, Canada (U)  
 Intertek, Santa Clara, CA (EC, DP, MP, R, U)  
 ISO-PACIFIC Remediation Technologies, Inc., Richland, WA (R, RT)  
 James Fisher Technologies, Loveland, CO (AC, EC, E, DP, FP, FL, GP, MP, R, RT, RS, S, U, UW)  
 JME Technologies, Crystal Lake, IL (E)  
 JNT Technical Services Inc., Little Ferry, NJ (I)  
 Joseph Oat Corp., Camden, NJ (EC, DP)  
 Kinectrics Inc., Toronto, Ontario, Canada (EC, S, U)  
 Laboratory Services, (Div. of Consumers Energy), Jackson, MI (AC, EC, DP, FP, I, MP, R, S, U)  
 Lambda Technologies, (Surface Enhancement Technologies, LLC and Lambda Research, Inc.), Cincinnati, OH (EC, DP, FP, RS, S)  
 ♦ Major Tool & Machine, (A Precinmac Company), Indianapolis, IN (DP, FP, MP, R, S, U)  
 Nuclear Energy Components Ltd, Hope Valley, Derbyshire, United Kingdom (DP, MP, U)  
 ♦ NUCON International, Inc., Columbus, OH (S)  
 Pajarito Scientific Corp., Santa Fe, NM (E, RT)  
 PAR Systems, LLC, Saint Paul, MN (EC, I, R, U, UW)  
 Paxton & Vierling Steel, Carter Lake, IA (DP, MP, U)  
 ♦ Petersen Inc. (A Precinmac Company), Ogden, UT (DP, MP, R, U)  
 ♦ Photonis, Brive la Gaillarde Cedex, France (E)  
 ♦ Precision Custom Components, LLC., (DC Fabricators), York, PA (AC, EC, DP, FP, MP, R, S, U)  
 Premier Technology, Inc., Blackfoot, ID (EC, DP, MP, R, U)  
 QingCheng Ltd., (QingCheng AE Institute), Guangzhou, China (AC, U)  
 River Technologies, LLC, Forest, VA (E)  
 Rogante Engineering Office, Civitanova Marche, Italy (R, RS)

Schulz Electric, Timken Power Systems, East Haven, CT (DP, FP, I, MP, S, U)  
 SKODA JS a.s., Plzen, Bolevec, Czech Republic (The) (EC, DP, FP, MP, R, U)  
 Sonic Systems International, LLC, Houston, TX (EC, DP, FP, FL, MP, R, S, U, UW)  
 Southwest Research Institute, San Antonio, TX (AC, EC, E, DP, GP, MP, R, S, U, UW)  
 ♦ System One, Pittsburgh, PA (EC, DP, FP, GP, I, MP, R, RT, RS, S, U)  
 Technisonic Research Inc., Fairfield, CT (U)  
 Technology for Energy Corp., Knoxville, TN (RS)  
 The Merrick Group, Inc., West Hazleton, PA (EC)  
 ♦ Thermal Engineering International (TEI), Cerritos, CA (EC)  
 Toshiba America Energy Systems Corp., West Allis, WI (AC, EC, E, DP, FP, FL, GP, I, MP, R, RT, RS, S, U, UW)  
 ♦ Underwater Construction Corp., (Underwater Construction Corp. UK Ltd.), Essex, CT (U)  
 University of Bristol, (Interface Analysis Centre) (South West Nuclear Hub), Bristol, United Kingdom (RS, S)  
 Westinghouse Electric Co. LLC, Cranberry Township, PA (EC, E, DP, FP, I, MP, S, U, UW)

♦ Curtiss-Wright Nuclear Division, Brea, CA (ND)  
 Curtiss-Wright Nuclear Division, Scientech, Idaho Falls, ID (ND)  
 E.S. Fox Limited, Niagara Falls, Ontario, Canada (PV)  
 Equipos Nucleares, S.A., S.M.E, Maliaño (Cantabria), Spain (PV, SG)  
 ♦ Framatome Inc., (North American Headquarters), Lynchburg, VA (ND, PV, S, SG)  
 Joseph Oat Corp., Camden, NJ (PV, S)  
 ♦ Mirion Technologies (IST) Corp., (Sensing Systems Div.), Horseheads, NY (PV)  
 Mirion Technologies, Inc., (Sensing Systems Div.), Atlanta, GA (PV)  
 ♦ Petersen Inc. (A Precinmac Company), Ogden, UT (GB)  
 Premier Technology, Inc., Blackfoot, ID (GB)  
 Radium Inc., Waynesboro, VA (ND)  
 Sonic Systems International, LLC, Houston, TX (PV, SG)  
 TW Metals - Nuclear Materials Solutions, Linden, MI (PV)  
 ♦ UniTech Services Group, Inc., (Div. of UniFirst Corp.), Longmeadow, MA (GB)  
 Westinghouse Electric Co. LLC, Cranberry Township, PA (ND, SG)

## 56750 Nozzles

GB Grit Blasting  
 ND Nozzle Dams, Steam Generator  
 PV Pressure Vessel  
 S Spray  
 SG Steam Generator

Baker Industries, a Lincoln Electric Company, Macomb, MI (PV)  
 BWX Technologies, Inc., Lynchburg, VA (PV, SG)  
 Carolina Fabricators, West Columbia, SC (ND, PV, SG)  
 Consolidated Power Supply, (Div. of Consolidated Pipe & Supply Co., Inc.), Birmingham, AL (PV, S, SG)

## 56900 Nuclear Steam Supply Systems

BWX Technologies, Inc., Lynchburg, VA  
 Equipos Nucleares, S.A., S.M.E, Maliaño (Cantabria), Spain  
 ♦ Framatome Inc., (North American Headquarters), Lynchburg, VA  
*See advertisement on pages 6-7*  
 GE Hitachi Nuclear Energy, Wilmington, NC  
 GSE Workforce Solutions, Training Services, (Formerly known as Hyperspring), Columbia, MD  
 Hybrid Power Technologies LLC, Overland Park, KS  
 Joseph Oat Corp., Camden, NJ



# PRECISION CUSTOM COMPONENTS

405,000 SQ. FEET OF MANUFACTURING, FABRICATION, AND NDT CAPABILITIES IN YORK, PA.

www.PCC-York.com 717-848-1126 X2400



EQUAL OPPORTUNITY  
**EMPLOYER**  
 WELDERS  
 MACHINISTS  
 FABRICATORS  
 NDT TECHNICIANS



REACTOR COMPONENTS  
 TRANSPORTATION CASKS AND EQUIPMENT  
 SPENT NUCLEAR FUEL COMPONENTS  
 HEAT EXCHANGERS  
 PRESSURE VESSELS

**SERVING THE ENERGY AND DEFENSE INDUSTRIES SINCE 1876**

◆ Denotes advertiser—see Index to Advertisers on pages 8-14

Mitsubishi Nuclear Energy Systems, Inc., (A Sub. of Mitsubishi Heavy Industries, Ltd.), Charlotte, NC  
NuScale Power, Portland, OR

◆ **Precision Custom Components, LLC., (DC Fabricators), York, PA**

Toshiba America Energy Systems Corp., West Allis, WI  
Westinghouse Electric Co. LLC, Cranberry Township, PA

◆ Westinghouse Electric Company LLC, (Westinghouse Parts Business), New Stanton, PA

**57000 Operating Experience Information Services**

◆ Curtiss-Wright Nuclear Division, Brea, CA  
Curtiss-Wright Nuclear Division, Scientech, Idaho Falls, ID  
GE Hitachi Nuclear Energy, Wilmington, NC  
Gravis Technologies, Inc., Wallace, ID  
NuclearN, Phoenix, AZ  
Tetra Tech Inc., Richland, WA

**57050 Orifices**

C Coupling  
FR Flow Restrictor  
M Multistage  
P Plate

BNL Industries, Inc., Vernon Rockville, CT (P)  
Carolina Fabricators, West Columbia, SC (C, FR, M, P)  
Consolidated Power Supply, (Div. of Consolidated Pipe & Supply Co., Inc.), Birmingham, AL (C, FR, M, P)  
Dragon Valves, Inc., Norwalk, CA (C, FR)  
◆ DuBose National Energy Services, Inc., Clinton, NC (P)  
Energy Steel, Rochester Hills, MI (FR, P)  
Joseph Oat Corp., Camden, NJ (C, FR, M, P)  
KROHNE, (KROHNE Nuclear), Romans-sur-Isère, France (FR, M, P)  
NuSource LLC, Alexandria, VA (C, FR, M, P)  
◆ Paragon Energy Solutions, (Paragon), Fort Worth, TX (C, FR, M, P)  
◆ Valcor Engineering Corp., (Valcor Nuclear Div.), Springfield, NJ (FR)  
◆ Westinghouse Electric Company LLC, (Westinghouse Parts Business), New Stanton, PA (C, FR, P)

**57400 Packings**

Dufrane Nuclear Shielding Inc., (Dufrane Nuclear Inc.), Winsted, CT  
Energy Steel, Rochester Hills, MI  
◆ Framatome Inc., (North American Headquarters), Lynchburg, VA

**57600 Paints**

BHI Energy - now Westinghouse, See listing for Westinghouse Electric Co., Cranberry Township, PA  
Cortec Corp., Saint Paul, MN  
Energy Steel, Rochester Hills, MI  
FEVDI Nuclear Decontamination, Corbas, France  
Paxton & Vierling Steel, Carter Lake, IA  
Scientific Sales, Inc., Oak Ridge, TN  
Westinghouse Electric Co. LLC, Cranberry Township, PA

**58000 Particle-Measuring Instruments**

◆ Framatome Inc., (North American Headquarters), Lynchburg, VA  
GE Hitachi Nuclear Energy, Wilmington, NC  
◆ HI-Q Environmental Products Co., Inc., San Diego, CA  
Mirion Technologies (Canberra) Inc., Meriden, CT  
Mirion Technologies, Inc., (Sensing Systems Div.), Atlanta, GA  
ORTEC, Oak Ridge, TN  
Radiation Pros, LLC, (dba Rad Pros), Englewood, CO

**58250 Penetrations, Containment**

E Electrical  
M Mechanical

AECON-WACHS, (U.S. Div. of Aecon Nuclear), Jackson, SC (E, M)  
BHI CO., LTD., Haman-gun, Korea (The Republic of) (M)  
Bilfinger Noell GmbH, (Dept. BEV), Wuerzburg, Germany (M)  
Carolina Fabricators, West Columbia, SC (E, M)  
Centronic Ltd., Surrey, United Kingdom (E, M)  
◆ Curtiss-Wright Nuclear Division, Brea, CA (E, M)  
Curtiss-Wright Nuclear Division, QualTech NP, Cincinnati, OH (E)  
Curtiss-Wright Nuclear Division, Scientech, Idaho Falls, ID (E, M)  
GE Hitachi Nuclear Energy, Wilmington, NC (E, M)  
GLSEQ, LLC, Huntsville, AL (E)  
Joseph Oat Corp., Camden, NJ (M)  
Kanata Electronic Services Ltd., (Div. of Shawcor Ltd.), Toronto, Ontario, Canada (E)  
Merrick & Company, Greenwood Village, CO (E, M)  
Mirion Technologies (IST Canada) ULC, (Formerly Mirion Technologies (IST Canada) Inc.), Cambridge, Ontario, Canada (E)

◆ **Mirion Technologies (IST) Corp., (Sensing Systems Div.), Horseheads, NY (E)**

Mirion Technologies, Inc., (Sensing Systems Div.), Atlanta, GA (E)  
Piping Technology & Products, Inc., Houston, TX (M)  
Premier Technology, Inc., Blackfoot, ID (M)  
SKODA JS a.s., Plzen, Bolevec, Czech Republic (The) (E)  
Teledyne Brown Engineering, Inc., Huntsville, AL (E)  
THERMOCOAX Inc., Alpharetta, GA (E)  
THERMOCOAX SAS, Caligny, France (E)  
Toshiba America Energy Systems Corp., West Allis, WI (M)  
Westinghouse Electric Co. LLC, Cranberry Township, PA (E)  
◆ Westinghouse Electric Company LLC, (Westinghouse Parts Business), New Stanton, PA (E, M)

**58800 Photogrammetry, Close-Range**

◆ Framatome Inc., (North American Headquarters), Lynchburg, VA  
Gamma Reality Inc., Richmond, CA  
Merrick & Company, Greenwood Village, CO



**MIRION**  
TECHNOLOGIES SENSING SYSTEMS DIVISION

**Operational Safety & Non-Safety Radiation Monitoring Equipment**

**Out-of-Core Detectors, In-Core Detectors & Electrical Penetrations**



*Proven quality SOLUTIONS to meet your requirements*

Sensing Systems Division  
315 Daniel Zenker Drive  
300 IST Center  
Horseheads, NY 14845 USA

Phone: 607-562-4530  
FAX: 607-562-4482  
Email: [ist@mirion.com](mailto:ist@mirion.com)



Copyright © 2017 Mirion Technologies, Inc. or its affiliates. All rights reserved. Mirion, the Mirion logo, and other trade names of Mirion products listed herein are registered trademarks or trademarks of Mirion Technologies, Inc. or its affiliates in the United States and other countries. Third party trademarks mentioned are the property of their respective owners.

**59800 Pipe**

- CS Carbon Steel, Seamless  
 CM Chrome Moly  
 CG Commercial Grade Dedication  
 CO Copper  
 L Lead  
 NC Nickel-Cobalt, Seamless  
 PL Plastic-Lined  
 SL Seamless  
 S Stainless  
 SS Stainless, Seamless  
 T Titanium  
 TS Titanium, Seamless  
 Z Zirconium  
 ZS Zirconium, Seamless
- AECON-WACHS, (U.S. Div. of Aecon Nuclear), Jackson, SC (CS, S)
- ◆AVANTech, LLC, Columbia, SC (S)  
 Burns & McDonnell, Kansas City, MO (CS, CM, S)  
 Carolina Fabricators, West Columbia, SC (CS, CM, CO, NC, SL, S, SS, T, TS)  
 Centronic Ltd., Surrey, United Kingdom (CS, CG, CO, L, NC, SL, S, SS, T, TS, Z, ZS)  
 Consolidated Power Supply, (Div. of Consolidated Pipe & Supply Co., Inc.), Birmingham, AL (CS, CM, CO, L, NC, PL, SL, S, SS, T, TS, Z, ZS)
- ◆DuBose National Energy Services, Inc., Clinton, NC (CS, CM, CO, L, NC, PL, SL, S, SS, T, TS, Z, ZS)
- E.S. Fox Limited, Niagara Falls, Ontario, Canada (CS, CM, CO, L, NC, PL, SL, S, SS, T, TS, Z, ZS)  
 Energy Steel, Rochester Hills, MI (CS, CM, CO, L, NC, PL, T, TS)
- ◆Framatome Inc., (North American Headquarters), Lynchburg, VA (SL, S, SS, Z, ZS)  
 FuseRing Inc., London, Ontario, Canada (CS, SL, S, SS, T, TS, Z, ZS)  
 H. Butting GmbH & Co. KG, Wittingen-Knesebeck, Germany (S, T)  
 Joseph Oat Corp., Camden, NJ (CS, CM, CO, SL, S, SS, T, TS, Z, ZS)  
 Lincoln Structural Solutions, Louisville, NE (CS, SL, S, SS)  
 MarShield Radiation Shielding, (Div. of Marswell Metal Industries Ltd.), Burlington, Ontario, Canada (L)  
 PMT Nuclear, Woodridge, IL (CS, CG, CO, L, NC, PL, SL, S, SS, T, TS)  
 Seafab Metals Co., (Div. of The Doe Run Co.), Casa Grande, AZ (L)  
 Tioga Pipe, Philadelphia, PA (CS, CM, NC, PL, SL, S, SS, T, TS, Z, ZS)  
 Toshiba America Energy Systems Corp., West Allis, WI (CS, CM, NC, SL, S, SS)  
 TW Metals - Nuclear Materials Solutions, Linden, MI (CS, CM, CO, NC, PL, SL, S, SS, T, TS, Z, ZS)  
 Westinghouse Electric Co. LLC, Cranberry Township, PA (Z, ZS)
- ◆Westinghouse Electric Company LLC, (Westinghouse Parts Business), New Stanton, PA (CS, CM, CO, L, NC, PL, SL, S, SS, T, TS, Z, ZS)

**59820 Pipe Bending Services**

- AECON-WACHS, (U.S. Div. of Aecon Nuclear), Jackson, SC  
 Baker Industries, a Lincoln Electric Company, Macomb, MI  
 Carolina Fabricators, West Columbia, SC
- ◆DuBose National Energy Services, Inc., Clinton, NC  
 E.S. Fox Limited, Niagara Falls, Ontario, Canada  
 Energy Steel, Rochester Hills, MI  
 H. Butting GmbH & Co. KG, Wittingen-Knesebeck, Germany  
 Joseph Oat Corp., Camden, NJ  
 NuSource LLC, Alexandria, VA  
 PMT Nuclear, Woodridge, IL

Tioga Pipe, Philadelphia, PA

**59850 Pipe & Tube Machinery & Equipment**

- B Bending, Pipe  
 BT Bending, Tube  
 BP Beveling, Pipe  
 BV Beveling, Tube  
 CR Crimpers, Tube  
 CP Cutting, Pipe  
 CT Cutting, Tube  
 CI Cutting, In-Place  
 EH Expanders, Tube, Hydraulic  
 EM Expanders, Tube, Mechanical  
 EJ Expansion Joints  
 F Fittings  
 IT Instrumentation Tubing, Orbital Welding  
 PO Primary, Orbital TIG Welding  
 RS Rounding & Sizing  
 T Threading, Pipe  
 W Weld End Preparation

AECON-WACHS, (U.S. Div. of Aecon Nuclear), Jackson, SC (B, BT, BP, BV, CR, CP, CT, CI, EH, EM, IT, PO, T, W)  
 ATS Industrial Automation, Inc. - Nuclear (UK), Blaby, Leicester, United Kingdom (CP, CT, CI)  
 ATS Industrial Automation, Inc. Nuclear (Canada), Cambridge, Ontario, Canada (CP, CT, CI)

- ◆Brokk Inc., (Sub. of Brokk-Sweden), (Nuclear Div.), Santa Fe, NM (CP, CT, CI)  
 Burns & McDonnell, Kansas City, MO (RS)  
 Carolina Fabricators, West Columbia, SC (B, BT, BP, BV, CR, CP, CT, CI, EH, EM, IT, PO, RS, T, W)  
 Centronic Ltd., Surrey, United Kingdom (CP, CT)  
 Consolidated Power Supply, (Div. of Consolidated Pipe & Supply Co., Inc.), Birmingham, AL (B, BT, BP, BV, CR, CP, CT, CI, EH, EM, IT, PO, RS, T, W)
- ◆DuBose National Energy Services, Inc., Clinton, NC (B)  
 E.H. Wachs, (A Div. of ITW), Lincolnshire, IL (BP, BV, CP, CT, CI, IT, PO, W)  
 EFCO USA, Inc., Charlotte, NC (PO)
- ◆Framatome Inc., (North American Headquarters), Lynchburg, VA (CT, CI, EH, EM, PO, W)  
 James Fisher Technologies, Loveland, CO (CI)  
 Magnatech LLC, East Granby, CT (IT, PO)  
 PMT Nuclear, Woodridge, IL (B, BT, BP, BV, CP, CT, PO, T, W)  
 PROTEM USA LLC, Evergreen, CO (CR, EH, EM, RS)  
 SERCO USA, Evergreen, CO (BP, BV, CR, CP, CT, CI, EH, EM, IT, PO, RS, T, W)  
 SUNG IL CO., LTD. (SIM), Busan, Korea (The Republic of) (B, BP, CP, T)  
 Teledyne Brown Engineering, Inc., Huntsville, AL (B, CP)  
 TW Metals - Nuclear Materials Solutions, Linden, MI (B, BT, BP)

**60100 Pipe Hangers & Supports**

- AECON-WACHS, (U.S. Div. of Aecon Nuclear), Jackson, SC  
 Carolina Fabricators, West Columbia, SC  
 Consolidated Power Supply, (Div. of Consolidated Pipe & Supply Co., Inc.), Birmingham, AL
- ◆Curtiss-Wright Nuclear Division, Brea, CA  
 Curtiss-Wright Nuclear Division, Nova, Middleburg Heights, OH  
 Curtiss-Wright Nuclear Division, QualTech NP, Cincinnati, OH
- ◆DuBose National Energy Services, Inc., Clinton, NC  
 E.S. Fox Limited, Niagara Falls, Ontario, Canada  
 Fronek - Anchor Darling Enterprises, Inc., (Sub. of Piping Technology & Products, Inc.), Laconia, NH  
 Integra Services Technologies Inc., Sarnia, Ontario, Canada

- ◆James C. White Company, Inc., Greenville, SC  
 Lincoln Structural Solutions, Louisville, NE  
 NuSource LLC, Alexandria, VA  
 Piping Technology & Products, Inc., Houston, TX  
 PMT Nuclear, Woodridge, IL
- ◆SSM Industries, Inc., (Nuclear Div.), Pittsburgh, PA  
 Tioga Pipe, Philadelphia, PA  
 Trust Manufacturing, LLC, Euclid, OH
- ◆Wagstaff Applied Technologies, Spokane, WA
- ◆Westinghouse Electric Company LLC, (Westinghouse Parts Business), New Stanton, PA

**60150 Pipe Joints**

- Carolina Fabricators, West Columbia, SC  
 Consolidated Power Supply, (Div. of Consolidated Pipe & Supply Co., Inc.), Birmingham, AL  
 Cross Manufacturing Co. (1938) Ltd., Bath, United Kingdom
- ◆DuBose National Energy Services, Inc., Clinton, NC  
 K-Tek International Inc., Wilsonville, OR  
 PMT Nuclear, Woodridge, IL
- ◆Westinghouse Electric Company LLC, (Westinghouse Parts Business), New Stanton, PA

**60450 Pipe Whip Restraints**

- Carolina Fabricators, West Columbia, SC
- ◆DuBose National Energy Services, Inc., Clinton, NC
- ◆Framatome Inc., (North American Headquarters), Lynchburg, VA  
 GE Hitachi Nuclear Energy, Wilmington, NC  
 NuSource LLC, Alexandria, VA  
 Piping Technology & Products, Inc., Houston, TX  
 Toshiba America Energy Systems Corp., West Allis, WI

**60900 Piping Systems**

- D Design  
 E Erection
- AECON-WACHS, (U.S. Div. of Aecon Nuclear), Jackson, SC (D, E)  
 Black & Veatch, Overland Park, KS (D)  
 Burns & McDonnell, Kansas City, MO (D, E)
- ◆Curtiss-Wright Nuclear Division, Brea, CA (D)  
 Curtiss-Wright Nuclear Division, Scientech, Idaho Falls, ID (D)
- ◆Dominion Engineering, Inc., Reston, VA (D)  
 E.S. Fox Limited, Niagara Falls, Ontario, Canada (D)  
 Energy Steel, Rochester Hills, MI (D)
- ◆Framatome Inc., (North American Headquarters), Lynchburg, VA (D, E)  
 GE Hitachi Nuclear Energy, Wilmington, NC (D)  
 Joseph Oat Corp., Camden, NJ (D)  
 Merrick & Company, Greenwood Village, CO (D)  
 Numerical Advisory Solutions, LLC, Cary, NC (D)  
 NuSource LLC, Alexandria, VA (D, E)
- ◆Petersen Inc. (A Precinmac Company), Ogden, UT (D)  
 PMT Nuclear, Woodridge, IL (D, E)  
 Premier Technology, Inc., Blackfoot, ID (D, E)  
 Red Wolf Associates, Cary, NC (D)
- ◆SSM Industries, Inc., (Nuclear Div.), Pittsburgh, PA (D, E)  
 Teledyne Brown Engineering, Inc., Huntsville, AL (D, E)  
 Toshiba America Energy Systems Corp., West Allis, WI (D, E)  
 TRAD - RayXpert, Labège cedex, France (D)

**61530 Plating & Anodizing**

- Baker Industries, a Lincoln Electric Company, Macomb, MI  
 Electrical Builders Inc. (EBI), St. Cloud, M

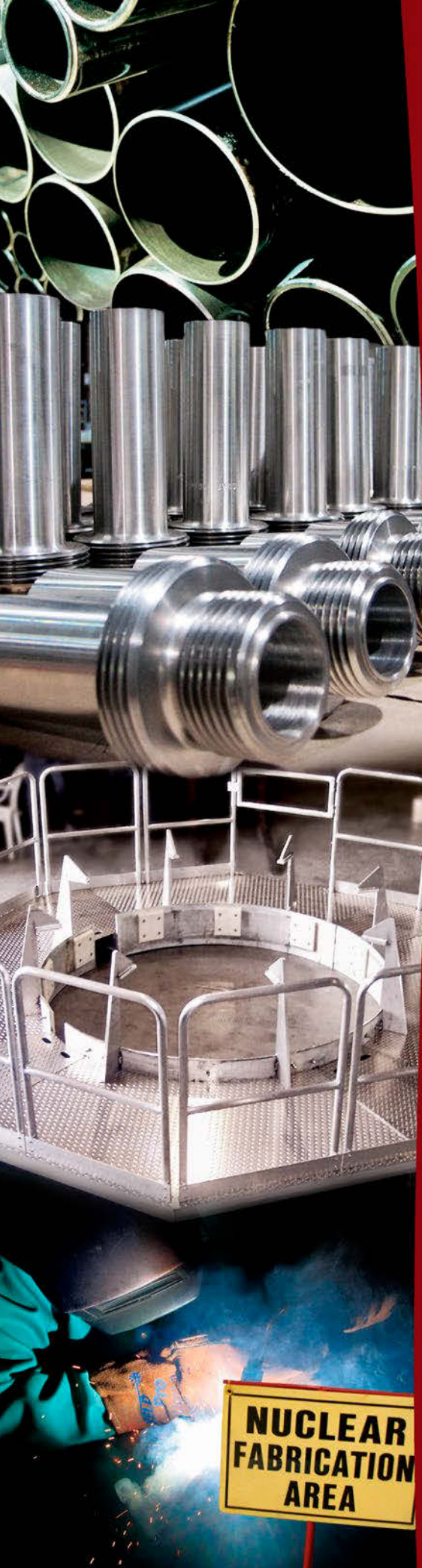

## Material

- Bar, Sheet, Plate, Structural Shapes
- Pipe, Tubing
- Rebar, Embeds, Anchor Systems
- Fittings, Forgings, Flanges
- Weld Filler Metal



## Fabrication/Industrial Coatings

- Structural, Piping, Sub-assemblies, Supports, Valve/Pump Components, Conduit Supports
- Project Management, 3D Modeling & Drafting
- CAD/CAM Drill Line, Plasma & Oxy Fuel Cutting Table
- GTAW, SAW, GMAW, FCAW & SMAW Welding Processes
- ASME Section IX & AWS D1.(x) Welding Procedures
- In-House Blasting & Coating with 60' x 22' x 16' Temp/RH Controlled Chambers



## Fasteners/Machined Parts

- Manufacture & stock ASME Section III, Nuclear Safety Related, MIL Spec Components
- Bolts, Screws, Studs, Nuts (Pressure Retaining, Structural, Metric)
- Socket Screws, Small Screws (Metric), Rivets, Pins, Washers
- In-house Machining of Various Custom Nuclear and Safety-Related Parts
- CNC Milling Machines, CNC Lathes, Wire EDM, Sinker EDM, Gun-Drilling, Thread Rolling



## Laboratory Services/Reverse Engineering

- Materials Testing: Chemical, Mechanical, Metallurgical Analysis
- Non-Destructive Examination: MT, LP, UT, VT
- Hydrostatic Pressure Testing
- Dimensional Inspection (CMM)
- Reverse Engineering: Obsolete Parts
- Commercial Grade Dedication

### 24/7 SERVICE



## OEM Partners

DuBose strategically partners with mission-critical suppliers to provide a one-stop-shop solution for our customers.

- Unistrut Metal Framing
- Cope Cable Management Systems
- Razor Ribbon Security Products

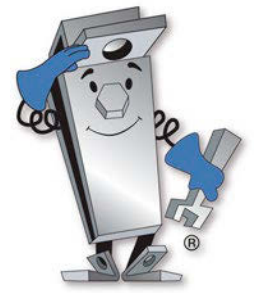

**Quality**



**Customer Service**



**Experience**



**Reliance**  
FAMILY OF COMPANIES

### 24/7 On-Call Emergency Service

**DuBose NES Inc.** (800) 590-2150 toll free  
900 Industrial Drive (910) 590-3555 fax  
Clinton, NC 28328 [www.dubosenes.com](http://www.dubosenes.com)  
[sales@dubosenes.com](mailto:sales@dubosenes.com)

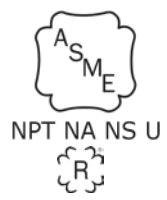

AISC  
CERTIFIED  
FABRICATOR

Our Quality Program is based on ASME Section III, NCA/ WA-4000 (\*Including Div. 5); 10CFR50 Appendix B; ASME NQA-1; ANSI N45.2; CAN 3-Z299; CSA N299 .2/.3/.4; EB-2678/Level I; & MIL-I-45208A. We additionally implement orders that require compliance with the applicable requirements of 10CFR 71 and 72. We are NUPIC and NIAC audited.

**NUCLEAR  
FABRICATION  
AREA**

**61570 Plugs**

- CT Condenser Tube  
 CR Control Rod Drive Housing  
 FH Feedwater Heater  
 F Freeze Plugs  
 HL Hot & Cold Leg (Remotely Installed)  
 I Isolation  
 MS Main Steam Line  
 MR Moisture Separator Reheater  
 P Pipeline  
 RP Reactor Pressure Vessel Drain Line  
 RV Reactor Vessel Nozzle  
 RO Recirculation Outlet Nozzle  
 SL Steamline (Remotely Installed)  
 SH Stud Hole  
 ST System Test
- AECON-WACHS, (U.S. Div. of Aecon Nuclear), Jackson, SC (CT)
- ◆ Alphasource, Inc., Philadelphia, PA (I, P)  
 Aquasol Corp., North Tonawanda, NY (P)  
 BWX Technologies, Inc., Lynchburg, VA (HL)  
 Carolina Fabricators, West Columbia, SC (CT, FH, HL, MS, P, RP, RV)  
 Consolidated Power Supply, (Div. of Consolidated Pipe & Supply Co., Inc.), Birmingham, AL (CT, CR, FH, I, RO, SH)
- ◆ Curtiss-Wright EST Group, Hatfield, PA (CT, FH)
- ◆ Curtiss-Wright Nuclear Division, Brea, CA (CT, CR, FH, HL, I, MS, P, RP, RV, RO, SL, SH)  
 Curtiss-Wright Nuclear Division, Nova, Middleburg Heights, OH (CR, I, RP, RO, SH)  
 Curtiss-Wright Nuclear Division, Scientech, Idaho Falls, ID (CT, CR, FH, HL, I, MS, P, RP, RV, RO, SL, SH)
- ◆ DuBose National Energy Services, Inc., Clinton, NC (CT, CR, FH, I, P, RP, RV, SL, SH, ST)  
 Energy Steel, Rochester Hills, MI (CR, I, MR)
- ◆ Framatome Inc., (North American Headquarters), Lynchburg, VA (CT, CR, FH, RV, SH)  
 Heat Exchanger Products Corp. (HEPCO), Hingham, MA (CT)  
 Hennigan Engineering LLC, Hingham, MA (CT)

JNT Technical Services Inc., Little Ferry, NJ (CT, FH, MR, SH)  
 Master-Lee Engineered Products Inc., Latrobe, PA (SH)

◆ Preferred Engineering Corp., (Sub. of Preferred Utilities Mfg. Corp.), Danbury, CT (CT, CR, FH, E, HL, I, MS, MR, P, RP, RV, RO, SL, SH, ST)

See advertisement on page 127

The Perma-Type Company, Inc., Plainville, CT (I, P)

- ◆ Thermal Engineering International (TEi), Cerritos, CA (CT, FH, MR)  
 Trust Manufacturing, LLC, Euclid, OH (CT, SH)  
 TW Metals - Nuclear Materials Solutions, Linden, MI (CT, FH, MR)
- ◆ Westinghouse Electric Company LLC, (Westinghouse Parts Business), New Stanton, PA (CT, CR, FH, E, HL, I, MS, MR, P, RP, RV, RO, SL, SH, ST)

**61800 Pneumatic Mechanisms**

- ◆ Framatome Inc., (North American Headquarters), Lynchburg, VA  
 ◆ Paragon Energy Solutions, (Paragon), Fort Worth, TX  
 Robotel Technologies, LLC, Roanoke, VA

**62100 Ponds, Spray**

Applied Analysis Corp., Reading, PA

**62200 Ports, Penetration**

- Merrick & Company, Greenwood Village, CO  
 ◆ Mirion Technologies (IST) Corp., (Sensing Systems Div.), Horseheads, NY  
 Mirion Technologies, Inc., (Sensing Systems Div.), Atlanta, GA

**62300 Post-Tensioning Materials & Systems, Containment Structure**

BHI CO., LTD., Haman-gun, Korea (The Republic of)

**62900 Power Plants, Nuclear, Gen IV Reactors**

Grecheck Consulting LLC, Midlothian, VA  
 Hybrid Power Technologies LLC, Overland Park, KS  
 Nuclear-21, Waasmunster, Belgium

**62910 Power Plants, Nuclear, Gen IV Reactors/Smart & Resilient**

- ◆ Curtiss-Wright Nuclear Division, Brea, CA  
 Grecheck Consulting LLC, Midlothian, VA  
 Hybrid Power Technologies LLC, Overland Park, KS  
 Nuclear-21, Waasmunster, Belgium  
 Power Generation Integrated, (PGICL), Etobicoke, Ontario, Canada

**63000 Power Plants, Nuclear, Platform-Mounted**

Mitsubishi Nuclear Energy Systems, Inc., (A Sub. of Mitsubishi Heavy Industries, Ltd.), Charlotte, NC  
 Nuclear-21, Waasmunster, Belgium  
 Perma-Fix Environmental Services, Inc., Oak Ridge, TN  
 Toshiba America Energy Systems Corp., West Allis, WI

**63400 Power Supplies**

- AC AC  
 C Chargers, Battery  
 DC DC  
 HF High-Frequency  
 HV High-Voltage  
 I Instrument  
 IN Inverters  
 PL Power Line Conditioner  
 S Stand-by  
 U Uninterruptible (AC-DC-AC)
- ◆ AVANTech, LLC, Columbia, SC (AC, DC, I, U)  
 Basic E, Inc., Charlotte, VT (AC, DC, HF, HV, I, PL, S, U)

**SAFE.  
RELIABLE.  
TRUSTED.**

**SAFE.  
RELIABLE.  
TRUSTED.**

**Pop-A-Plug® Tube Plugs****ASME PCC-2 Compliant Heat Exchanger Tube Plugging Solution**

Trusted by Nuclear Power plants around the world as their preferred tube plugging method, Pop-A-Plug Tube Plugs from Curtiss-Wright are engineered for optimal performance throughout the lifecycle of heat exchanger equipment. Controlled hydraulic installation eliminates welding and time-consuming pre-/post-weld heat treatments that can cause damage to tubes, tube sheet ligaments, and joints.

- Pressure ratings up to 7000 PsiG (483 BarG)
- Wide range of sizes/materials to accommodate any application
- 100% lot tested to ensure unmatched quality

877.238.3092

| est-sales@curtisswright.com

| cw-estgroup.com /nn-24

**CURTISS-  
WRIGHT**

**EST Group**



## ♦ Denotes advertiser—see Index to Advertisers on pages 8–14

Black & Veatch, Overland Park, KS (S)  
CAEN SyS, (CAEN SpA), Viareggio, LU, Italy (HV)

- ♦ Curtiss-Wright Nuclear Division, Brea, CA (AC, DC, HV, I, PL, S, U)  
Curtiss-Wright Nuclear Division, QualTech NP, Cincinnati, OH (AC, DC, HV, I, PL, S, U)  
Curtiss-Wright Nuclear Division, Scientech, Idaho Falls, ID (AC, DC, I)  
Electrical Builders Inc. (EBI), St. Cloud, MN (AC, DC, HF, HV, S)
- ♦ Element Nuclear (NTS Labs), (Nuclear Engineering & Test Services), Huntsville, AL (AC, DC, U)  
GUTOR, Houston, TX (AC, DC, I, PL, S, U)  
ISO-PACIFIC Remediation Technologies, Inc., Richland, WA (U)  
ORTEC, Oak Ridge, TN (I)
- ♦ Paragon Energy Solutions, (Paragon), Fort Worth, TX (AC, C, DC, HF, HV, I, IN, PL, S, U)  
Schaefer Electronics, Inc., Hopkinton, MA (AC, C, DC, HV, IN, PL, S)  
Scientific Sales, Inc., Oak Ridge, TN (AC, C, DC)  
Toshiba America Energy Systems Corp., West Allis, WI (AC, DC, HF, HV, I, PL, S, U)  
Westinghouse Electric Co. LLC, Cranberry Township, PA (AC, DC, HF, HV, I, PL, S, U)
- ♦ Westinghouse Electric Company LLC, (Westinghouse Parts Business), New Stanton, PA (AC, DC, HF, HV, I, PL, S, U)

**63800 Preamplifiers**

- Basic E, Inc., Charlotte, VT
- ♦ Bot Engineering Ltd, Campbellville, Ontario, Canada  
CAEN SyS, (CAEN SpA), Viareggio, LU, Italy  
Centronic Ltd., Surrey, United Kingdom  
Mirion Technologies (Canberra) Inc., Meriden, CT  
Mirion Technologies (IST Canada) ULC, (Formerly Mirion Technologies (IST Canada) Inc.), Cambridge, Ontario, Canada
- ♦ Mirion Technologies (IST) Corp., (Sensing Systems Div.), Horseheads, NY  
Mirion Technologies (MGPI H&B) GmbH, (Mirion Technologies), Munich, Germany  
Mirion Technologies, Inc., (Sensing Systems Div.), Atlanta, GA  
ORTEC, Oak Ridge, TN
- ♦ Paragon Energy Solutions, (Paragon), Fort Worth, TX  
Westinghouse Electric Co. LLC, Cranberry Township, PA
- ♦ Westinghouse Electric Company LLC, (Westinghouse Parts Business), New Stanton, PA

**64000 Presses, Pellet & Slug Forming, Powder Compacting**

- ♦ Framatome Inc., (North American Headquarters), Lynchburg, VA
- ♦ Petersen Inc. (A Precinmac Company), Ogden, UT

**64120 Pressurizers, Reactor**

- BWX Technologies, Inc., Lynchburg, VA
- ♦ Framatome Inc., (North American Headquarters), Lynchburg, VA  
Mitsubishi Nuclear Energy Systems, Inc., (A Sub. of Mitsubishi Heavy Industries, Ltd.), Charlotte, NC
- ♦ Precision Custom Components, LLC., (DC Fabricators), York, PA  
PROTEM USA LLC, Evergreen, CO  
SERCOS USA, Evergreen, CO

**64190 Process Irradiation Facilities**

- E Electron Beam
- G Gamma
- Tyne USA Inc., Jacksonville, FL (E, G)

**64300 Protective Coverings & Tarpaulins**

- ♦ Alphasource, Inc., Philadelphia, PA  
JSM Protective, Inc., Port St. Lucie, FL

- Lancs Industries, Albuquerque, NM  
Mohawk Safety, Inc., Manchester, CT
- ♦ Reef Industries, Inc., (Griffolyn, Div. of Reef Industries, Inc.), Houston, TX  
Rich Industries Inc., New Philadelphia, OH
- ♦ Strategic Packaging Systems, (I.C.E. Packaging Company, LLC), Madisonville, TN

**64312 Public & Community Relations**

- EmmEn Marketing Consultants, Pune, Maharashtra, India  
Full On Communications, Woodstock, VT  
Gravis Technologies, Inc., Wallace, ID  
Navarro, Oak Ridge, TN  
Orano USA, Bethesda, MD
- ♦ Radiation Safety & Control Services, Inc., Seabrook, NH  
Southwest Research Institute, San Antonio, TX

**64315 Publications**

- Nuclear News Magazine, Westmont, IL  
OECD Nuclear Energy Agency (NEA), Paris, France  
Radwaste Solutions Magazine, Westmont, IL

**64320 Pulsation Dampeners, Piping**

- Joseph Oat Corp., Camden, NJ  
NuSource LLC, Alexandria, VA

**64480 Pump Face Seal Protection**

- Electro Static Technology, Mechanic Falls, ME  
KSB, Inc., Henrico, VA

**64700 Pumps, Centrifugal**

- CW Condensate & Circulating Water
- E3 Engineered Class III
- HD Heater Drain
- NR Non-Code Radwaste
- N2 Nuclear Class II
- PC Primary Coolant

- RF Reactor Feed
- SW Service Water, Non-Code
- SN Service Water, Nuclear Class III
- SC Small Class III Including Radwaste
- Electro Static Technology, Mechanic Falls, ME (PC)  
Energy Steel, Rochester Hills, MI (CW, E3, N2, SC)
- ♦ Framatome Inc., (North American Headquarters), Lynchburg, VA (CW, PC, RF)  
Hayward Tyler Inc., Colchester, VT (CW, N2, PC, RF, SW, SN)  
Hydro, Inc., (HydroAire Services Division), Chicago, IL (CW, HD, NR, N2, PC, RF, SW, SN, SC)  
ISO-PACIFIC Remediation Technologies, Inc., Richland, WA (NR)  
KSB, Inc., Henrico, VA (CW, E3, HD, N2, PC, RF, SW, SN, SC)  
Mitsubishi Nuclear Energy Systems, Inc., (A Sub. of Mitsubishi Heavy Industries, Ltd.), Charlotte, NC (CW, E3, HD, NR, N2, PC, RF, SW, SN, SC)
- ♦ Paragon Energy Solutions, (Paragon), Fort Worth, TX (CW, E3, HD, NR, N2, PC, RF, SW, SN, SC)
- ♦ The Park Company, Pasco, WA (CW, E3, HD, PC)  
Sulzer Management Ltd., (Sulzer Pumps (Canada) Inc.), Burnaby, British Columbia, Canada (CW, E3, HD, N2, PC, RF, SW, SN)  
Sulzer Pumps (US) Inc., Chattanooga, TN (CW, E3, HD, N2, PC, RF, SW, SN)  
Toshiba America Energy Systems Corp., West Allis, WI (CW, E3, HD, NR, N2, PC, RF, SW, SN, SC)  
Westinghouse Electric Co. LLC, Cranberry Township, PA (E3, N2, PC, RF, SN, SC)
- ♦ Westinghouse Electric Company LLC, (Westinghouse Parts Business), New Stanton, PA (CW, E3, HD, NR, N2, PC, RF, SW, SN, SC)

# STAY PROTECTED.

GRIFFOLYN® CAN HELP WITH  
PLANT MAINTENANCE & OUTAGE MANAGEMENT



NFPA 701 CERTIFIED • FME PROTECTION • ON-SITE STORAGE  
NO DELAYS IN OUTAGES • OUTDOOR TRANSPORTATION  
STOCK ROLLS READILY AVAILABLE • HOT WORK AREAS

800.231.6074 • GRIFFOLYN.COM



DIVISION OF REEF INDUSTRIES, INC.

**64750 Pumps, Other**

- A Air-Operated
- CL Cleanup
- CA Containment Air/Gas Sampling
- DH Diaphragm, Hydraulically Actuated
- FP Fire Protection
- HO Hand-Operated
- HP High-Pressure
- HY Hydraulic
- J Jet
- MP Metering & Proportioning
- PD Positive-Displacement
- SR Sealless Reciprocating
- SL Slurry
- SO Sodium
- SP Special-Purpose
- V Vacuum
- ◆AVANTech, LLC, Columbia, SC (A, CL, MP, PD, SL, V)
- Basic E, Inc., Charlotte, VT (DH, MP, PD, SP)
- BHI Energy - now Westinghouse, See listing for Westinghouse Electric Co., Cranberry Township, PA (SL, SP)
- ◆Curtiss-Wright Nuclear Division, Brea, CA (A, HY)
- Curtiss-Wright Nuclear Division, Nova, Middleburg Heights, OH (A, HY)
- E.H. Wachs, (A Div. of ITW), Lincolnshire, IL (HY)
- Energy Steel, Rochester Hills, MI (HP, PD)
- F.E. Moran Special Hazard Systems, Northbrook, IL (FP)
- ◆F&J SPECIALTY PRODUCTS, INC., Ocala, FL (CA, V)
- GE Hitachi Nuclear Energy, Wilmington, NC (I)
- ◆HI-Q Environmental Products Co., Inc., San Diego, CA (CA, V)
- Hydro, Inc., (HydroAire Services Division), Chicago, IL (HP, HY, PD, SR, SL)
- Integra Services Technologies Inc., Sarnia, Ontario, Canada (HP, HY)
- KSB, Inc., Henrico, VA (CL, HP, J, SL, SO, SP)
- Lancs Industries, Albuquerque, NM (HO)
- Mitsubishi Nuclear Energy Systems, Inc., (A Sub. of Mitsubishi Heavy Industries, Ltd.), Charlotte, NC (A, CA, DH, HO, HP, HY, J, MP, PD, SR, SL, SO, SP, V)
- Nextteq International LLC, Tampa, FL (CA)
- ORTEC, Oak Ridge, TN (V)
- ◆Paragon Energy Solutions, (Paragon), Fort Worth, TX (A, DH, HO, HY, PD, SO, V)
- ◆The Park Company, Pasco, WA (HP, HY, MP, V)
- Radiological Solutions Inc., Rockdale, IL (HP, MP, PD)
- ◆Schutte and Koerting, Treviso, PA (J, V)
- Sulzer Management Ltd., (Sulzer Pumps (Canada) Inc.), Burnaby, British Columbia, Canada (HP, SO, SP)
- Toshiba America Energy Systems Corp., West Allis, WI (HP, HY, J, SR, V)
- Transco Products Inc., Streator, IL (FP)
- Tyne USA Inc., Jacksonville, FL (HP, V)
- Westinghouse Electric Co. LLC, Cranberry Township, PA (PD, SL, SP)
- ◆Westinghouse Electric Company LLC, (Westinghouse Parts Business), New Stanton, PA (A, CA, DH, HO, HP, HY, J, MP, PD, SR, SL, SO, SP, V)

**66200 Quality Assurance Services**

- I ISO 9001 = 2000
- Applied Analysis Corp., Reading, PA (I)
- Baker Industries, a Lincoln Electric Company, Macomb, MI (I)
- Black & Veatch, Overland Park, KS (I)
- Bureau Veritas Inspection and Insurance Co., (previously OneCIS Inspection and Insurance Co.), Lynn, MA (I)
- Burns & McDonnell, Kansas City, MO (I)
- ◆Curtiss-Wright Nuclear Division, Brea, CA (I)
- Curtiss-Wright Nuclear Division, NETCO, Danbury, CT (I)
- Curtiss-Wright Nuclear Division, Scientech, Idaho Falls, ID (I)
- DCS Systems, Inc., Simsbury, CT (I)
- ◆Framatome Inc., (North American Headquarters), Lynchburg, VA (I)
- GE Hitachi Nuclear Energy, Wilmington, NC (I)

- Global Quality Management Advisors, Lynchburg, VA (I)
- GLSEQ, LLC, Huntsville, AL (I)
- GSE Solutions, (GSE Systems), Columbia, MD (I)
- Klein Consulting LLC, Norwich, CT (I)
- Mirion Technologies (C Canberra) Inc., Meriden, CT (I)
- National Inspection & Consultants, Fort Myers, FL (I)
- Nucleonova S.L., Valencia, Spain (I)
- Pajarito Scientific Corp., Santa Fe, NM (I)
- Perma-Fix Environmental Services, Inc., Oak Ridge, TN (I)
- Howard L. Sobel, P.E., Oceanside, NY (I)
- ◆System One, Pittsburgh, PA (I)
- Teledyne Brown Engineering, Inc., Huntsville, AL (I)
- Tetra Tech Inc., Richland, WA (I)

**66280 Racks, Fuel Storage**

- C Conventional
- HD High-Density
- Babcock Services, Inc., Kennewick, WA (C, HD)
- Baker Industries, a Lincoln Electric Company, Macomb, MI (C, HD)
- Bilfinger Noell GmbH, (Dept. BEV), Wuerzburg, Germany (HD)
- Carolina Fabricators, West Columbia, SC (C, HD)
- ◆Curtiss-Wright Nuclear Division, Brea, CA (C)
- Curtiss-Wright Nuclear Division, Scientech, Idaho Falls, ID (C)
- ◆DuBose National Energy Services, Inc., Clinton, NC (C)
- Dufrane Nuclear Shielding Inc., (Dufrane Nuclear Inc.), Winsted, CT (C, HD)
- Equipos Nucleares, S.A., S.M.E, Maliaño (Cantabria), Spain (C, HD)
- ◆Framatome Inc., (North American Headquarters), Lynchburg, VA (C, HD)
- GE Hitachi Nuclear Energy, Wilmington, NC (C, HD)
- H. Butting GmbH & Co. KG, Wittingen-Knesebeck, Germany (C, HD)
- ◆Holtec International, Camden, NJ (C, HD)
- ISO-PACIFIC Remediation Technologies, Inc., Richland, WA (HD)
- Joseph Oat Corp., Camden, NJ (C, HD)
- ◆Major Tool & Machine, (A Precinmac Company), Indianapolis, IN (C, HD)
- Nuclear Energy Components Ltd, Hope Valley, Derbyshire, United Kingdom (C)
- Nuclear Shielding Supplies & Service, Tucson, AZ (HD)
- NuSource LLC, Alexandria, VA (C)
- PAR Systems, LLC, Saint Paul, MN (C, HD)
- ◆Precision Custom Components, LLC., (DC Fabricators), York, PA (C, HD)
- Robatel Technologies, LLC, Roanoke, VA (C, HD)
- Teledyne Brown Engineering, Inc., Huntsville, AL (C)
- Toshiba America Energy Systems Corp., West Allis, WI (C, HD)
- TW Metals - Nuclear Materials Solutions, Linden, MI (C)
- ◆Underwater Construction Corp., (Underwater Construction Corp. UK Ltd.), Essex, CT (HD)
- ◆Wagstaff Applied Technologies, Spokane, WA (C)
- Westinghouse Electric Co. LLC, Cranberry Township, PA (C, HD)
- ◆Westinghouse Electric Company LLC, (Westinghouse Parts Business), New Stanton, PA (C, HD)

**67380 Radiation Monitoring Services**

- A Analog Systems
- DR Design, Retrofit
- D Digital Systems
- M Maintenance
- MO Mobile (Vehicular)
- SE Sample Encapsulation
- SS Smear Sampling, Area/Environmental
- TC Testing & Calibration
- Advetage Solutions, El Segundo, CA (SS, TC)
- Applied Science Professionals, LLC, (ASP-LLC), Salt Lake City, UT (TC)

- ARES Security Corp., Vienna, VA (MO)
- Aurum Technologies, Blackfoot, ID (DR, D, MO)
- Bertin Technologies, France (M, TC)
- BHI Energy - now Westinghouse, See listing for Westinghouse Electric Co., Cranberry Township, PA (A, DR, D, M, MO, SS, TC)
- Cabrera Services Inc., East Hartford, CT (SS, TC)
- Campoverde srl, Milano, Italy (SS, TC)
- ◆Curtiss-Wright Nuclear Division, Brea, CA (DR)
- Curtiss-Wright Nuclear Division, Scientech, Idaho Falls, ID (DR)
- Eckert & Ziegler Analytics, Atlanta, GA (SS)
- General Atomics Electromagnetic Systems, San Diego, CA (A, DR, D, M, TC)
- ISO-PACIFIC Remediation Technologies, Inc., Richland, WA (TC)
- James Fisher Technologies, Loveland, CO (MO)
- Mirion Technologies (C Canberra) Inc., Meriden, CT (A, DR, D, MO, SS, TC)
- Navarro, Oak Ridge, TN (DR, M, SE, SS)
- NSSI/Recovery Services Inc., Houston, TX (SE, SS, TC)
- Numerical Advisory Solutions, LLC, Cary, NC (A, DR, D)
- Pajarito Scientific Corp., Santa Fe, NM (DR, MO, TC)
- ◆Paragon Energy Solutions, (Paragon), Fort Worth, TX (A, D)
- Perma-Fix Environmental Services, Inc., Oak Ridge, TN (A, DR, D, M, MO, SE, SS, TC)
- Radiation Pros, LLC, (dba Rad Pros), Englewood, CO (A, SS)
- ◆Radiation Safety & Control Services, Inc., Seabrook, NH (SS, TC)
- Radiological Solutions Inc., Rockdale, IL (TC)
- ReNuke, Oak Ridge, TN (SS, TC)
- Technical Associates, (a Div. of US Nuclear Corp.), Canoga Park, CA (A, D, MO, TC)
- Tyne USA Inc., Jacksonville, FL (A, DR, D, SS)
- US Nuclear Corp., (Technical Associates Sub.), (Overhoff Technology Corp. Sub.), Canoga Park, CA (TC)
- Veolia Nuclear Solutions - Federal Services, Piketon, OH (DR, TC)
- Westinghouse Electric Co. LLC, Cranberry Township, PA (A, DR, D, M, MO, SS, TC)

**68000 Radioactive Waste Handling & Treatment Equipment**

- CA Calciners
- CO Compactors
- CN Concentrators (Cross-Flow Filter)
- CS Crushers, Scintillation Vials
- DC Drum Capping Machines, Remote
- DR Drum Cutting Machines
- DW Drum Washing Systems, Automatic
- E Evaporators
- F Furnaces for Glass Melting
- GC Gas Compressors
- I Incinerators
- L Liners
- LV Liquid Volume Reduction
- P Packaging
- R Robotic
- SC Secondary Containment Products
- SH Shredders (Volume Reduction)
- S Solidification
- SS Sorters, Sorting Tables
- ST Storage Systems, On-Site, High-Level
- SF Storage Systems, On-Site, Low-Level
- V Vacuums
- WT Waste Tracking & Accountability Systems (Computerized)

- Accelerated Decommissioning Partners - ADP, Dallas, TX (ST, SF)
- Alaron Nuclear Services, (Veolia Nuclear Solutions Federal Services - Alaron), Wampum, PA (CO, DR, P, WT)
- ATS Industrial Automation, Inc. - Nuclear (UK), Blaby, Leicester, United Kingdom (CO, P, R, SH, S, SS, WT)
- ATS Industrial Automation, Inc. Nuclear (Canada), Cambridge, Ontario, Canada (CO, P, R, SH, S, SS, WT)
- ◆AVANTech, LLC, Columbia, SC (CN, E, L, LV, P, S, SF)
- Babcock Services, Inc., Kennewick, WA (CO)

◆ Denotes advertiser—see Index to Advertisers on pages 8-14

Bilfinger Noell GmbH, (Dept. BEV), Wuerzburg, Germany (CO, DC, DR, L, P, S, SS, SF)

◆ Boston Government Services, LLC (BGS), Oak Ridge, TN (WT)

Brokk AB, Skelleftea, Sweden (R)

◆ Brokk Inc., (Sub. of Brokk-Sweden), (Nuclear Div.), Santa Fe, NM (R)

CAEN SyS, (CAEN SpA), Viareggio, LU, Italy (WT)

Central Research Laboratories, Red Wing, MN (P)

Container Technologies Industries, LLC, Helenwood, TN (P)

Croft Associates Ltd, Abingdon, Oxfordshire, United Kingdom (P, ST, SF)

Deep Isolation, Inc., Berkeley, CA (ST)

Deltech Furnaces, (Deltech, Inc.), Denver, CO (F)

Deltech Kiln and Furnace Design, LLC, Denver, CO (F)

Desco Mfg. Co., Inc., Rancho Santa Margarita, CA (V)

◆ Dominion Engineering, Inc., Reston, VA (CN, R)

Dufrane Nuclear Shielding Inc., (Dufrane Nuclear Inc.), Winsted, CT (L, P, ST, SF)

DW James Consulting, LLC, North Oaks, MN (WT)

E.H. Wachs, (A Div. of ITW), Lincolnshire, IL (DR, R)

◆ EnergySolutions, Salt Lake City, UT (CO, F, I, L, P, SH, S, SF, WT)

Equipos Nucleares, S.A., S.M.E, Maliaño (Cantabria), Spain (CO, CN, DC, DW, E)

◆ Frham Safety Products, Inc., Rock Hill, SC (L)

General Plastics Mfg. Co., Tacoma, WA (L)

GNS Gesellschaft fur Nuklear-Service mbH, Essen, Germany (CO, CN, P, ST, SF, V, WT)

◆ Holtec International, Camden, NJ (ST, SF)

Hopewell Designs, Inc., Alpharetta, GA (P, SF)

◆ I.C.E. Service Group, Inc., Moon Township, PA (P, WT)

James Fisher Technologies, Loveland, CO (DC, DR, R, SC)

Joseph Oat Corp., Camden, NJ (E, L, ST)

Kinectrics Inc., Toronto, Ontario, Canada (L)

Komline, Peapack, NJ (CA)

Lancs Industries, Albuquerque, NM (L)

M2 Polymer Technologies, Inc., West Dundee, IL (P, S)

Merrick & Company, Greenwood Village, CO (CA, CO, CN, DW, E, R, SC, S, SS, ST, SF, V)

METOIL, Praha, Czech Republic (The) (LV)

Mirion Technologies (Canberra) Inc., Meriden, CT (WT)

Mitsubishi Nuclear Energy Systems, Inc., (A Sub. of Mitsubishi Heavy Industries, Ltd.), Charlotte, NC (CA, CO, CN, CS, DC, DR, DW, E, F, GC, I, L, P, R, SC, SH, S, SS, ST, SF, WT)

◆ NAC International Inc., Peachtree Corners, GA (P, ST)

NAC LPT LLC, Mars, PA (P)

Navarro, Oak Ridge, TN (P, ST, SF, WT)

NFT, (by Alpha Safety Group), Golden, CO (P)

NSSI/Recovery Services Inc., Houston, TX (S, SF)

◆ NUCON International, Inc., Columbus, OH (CA)

NuVision-HWM, (Wälischmiller Engineering), Pittsburgh, PA (DC, DR, R)

Orano Decommissioning Services, Hudson, MA (ST, SF)

Orano Federal Services, Charlotte, NC (CA, P, R)

Orano TN, Columbia, MD (ST, SF)

Orano USA, Bethesda, MD (CO, P, R, SH, S, ST, SF)

◆ PacTec, Inc., Clinton, LA (L, P, SC, SF)

Pajarito Scientific Corp., Santa Fe, NM (V)

PAR Systems, LLC, Saint Paul, MN (DC, DR, DW, P, R)

Perma-Fix Environmental Services, Inc., Oak Ridge, TN (SH, S, SS, ST, SF, WT)

◆ Petersen Inc. (A Precinmac Company), Ogden, UT (CA, CS, F, I, SC, SH)

Premier Technology, Inc., Blackfoot, ID (P, SC)

PTP Spent Fuel Services, LLC, Grand Island, NY (ST, SF)

Radiation Protection Systems, (by Alpha Safety), Groton, CT (SC, SS)

Radiological Solutions Inc., Rockdale, IL (S)

◆ Reef Industries, Inc., (Griffolyn, Div. of Reef Industries, Inc.), Houston, TX (P, SC, SF)

Rich Industries Inc., New Philadelphia, OH (L)

Robatel Technologies, LLC, Roanoke, VA (CA, CO, CN, CS, DC, DR, DW, E, F, GC, I, L, P, R, SC, SH, S, SS, ST, SF, V)

Rousselet-Robatel, Pittsfield, MA (CN, LV)

S&G Enterprises, Inc., Germantown, WI (CO, CS, SH)

Siempelkamp NIS, Alzenau, Germany (P)

Skolnik Industries, Chicago, IL (P, SC)

◆ Strategic Packaging Systems, (I.C.E. Packaging Company, LLC), Madisonville, TN (L, P)

Toshiba America Energy Systems Corp., West Allis, WI (P, ST, SF, WT)

Tri Nuclear Corp., Troy, NY (CO)

◆ UniTech Services Group, Inc., (Div. of UniFirst Corp.), Longmeadow, MA (SC, SS)

Veolia Nuclear Solutions - Federal Services, Piketon, OH (R)

◆ Wagstaff Applied Technologies, Spokane, WA (CO, DC, DR, DW, E, L, LV, P, R, SC, SH, SS, ST, SF)

Walischmiller Engineering GmbH, Markdorf, Baden-Wuerttemberg, Germany (R)

Waste Control Systems, Inc., Phoenix, MD (CO, CS, SC, SH, SS)

Westinghouse Electric Co. LLC, Cranberry Township, PA (CO, CN, CS, DC, DR, DW, E, P, R, SC, SH, S, SS, ST, SF, V, WT)

◆ WMG, Inc., Peekskill, NY (L, P, WT)

**68800 Radiographic Equipment & Accessories**

G Gamma Ray

N Neutron

X X-ray

3D PLUS, (Detection Systems), Versailles, France (G)

ANTECH Corp., Arvada, CO (G, N, X)

Berkeley Nucleonics Corp., San Rafael, CA (G, N)

Centronic Ltd., Surrey, United Kingdom (G, N, X)

DETEK, Temple Hills, MD (G, X)

H3D, Inc., Ann Arbor, MI (G)

Mirion Technologies (Canberra) Inc., Meriden, CT (G, N, X)

NETCo, Windsor, ME (X)

PAR Systems, LLC, Saint Paul, MN (X)

PHDS Co., Knoxville, TN (G)

Transco Products Inc., Streator, IL (G)

**68900 Radiography (Services)**

G Gamma

N Neutron

Centronic Ltd., Surrey, United Kingdom (G, N)

◆ Framatome Inc., (North American Headquarters), Lynchburg, VA (G, N)

Laboratory Services, (Div. of Consumers Energy), Jackson, MI (G)

National Inspection & Consultants, Fort Myers, FL (G)

Pajarito Scientific Corp., Santa Fe, NM (G, N)

Rogante Engineering Office, Civitanova Marche, Italy (N)

Transco Products Inc., Streator, IL (G)

**68950 Radioisotopes**

CS Calibration Standards

F Foils

G Gases, Calibration

LC Labeled Compounds

PP Primary & Processed

RS Radiation Standards

RC Radiochemicals

RM Radioisotopes, Medical

RP Radiopharmaceuticals

RE Recycling

SS Sealed Sources

UH Ultra-High Activity

Alaron Nuclear Services, (Veolia Nuclear Solutions Federal Services - Alaron), Wampum, PA (RE, SS)

ATS Industrial Automation, Inc. - Nuclear (UK), Blaby, Leicester, United Kingdom (RM, RP)

ATS Industrial Automation, Inc. Nuclear (Canada), Cambridge, Ontario, Canada (RM, RP)

BWX Technologies, Inc., Lynchburg, VA (RM, RP)

Campoverde srl, Milano, Italy (CS, F, G, LC, RS, RC, RM)

Curie Environmental Services, Albuquerque, NM (RE)

Eckert & Ziegler Analytics, Atlanta, GA (CS, F, G, PP, RS, RC, SS)

◆ Framatome Inc., (North American Headquarters), Lynchburg, VA (CS, RS, RP, SS)

Frontier Technology Corp., Xenia, OH (RM, SS)

General Atomics Electromagnetic Systems, San Diego, CA (CS, SS)

International Isotopes, Inc., (RadQual), Idaho Falls, ID (CS, RS, RC, RM, RP, RE, SS, UH)

ISO-PACIFIC Remediation Technologies, Inc., Richland, WA (RS)

Kinectrics Inc., Toronto, Ontario, Canada (CS, G, RS)

Mirion Technologies (Canberra) Inc., Meriden, CT (CS, SS)

NAC Philotechnics, Ltd., Oak Ridge, TN (CS, F, RS, RE, SS)

NSSI/Recovery Services Inc., Houston, TX (RE, SS)

Nuclear-21, Waasmunster, Belgium (RM, RP)

Orano USA, Bethesda, MD (RM, SS)

Perma-Fix Environmental Services, Inc., Oak Ridge, TN (RM, RP, RE)

PHDS Co., Knoxville, TN (RM, RP)

Pylon Electronics Inc., (Instrument Manufacturing Div.), Ottawa, Ontario, Canada (G, SS)

◆ Radiation Safety & Control Services, Inc., Seabrook, NH (RS)

RadQual, LLC, Idaho Falls, ID (CS, G, RS, RC, RM, SS)

Robatel Technologies, LLC, Roanoke, VA (RM, RP)

J. L. Shepherd & Assoc., San Fernando, CA (CS, RS, RE, SS)

**69130 RateMeters, Counting**

Advetage Solutions, El Segundo, CA

Berthold Technologies USA LLC, Oak Ridge, TN

◆ Bot Engineering Ltd, Campbellville, Ontario, Canada

Environmental Restoration Group, Inc., Albuquerque, NM

General Atomics Electromagnetic Systems, San Diego, CA

Ludlum Measurements, Inc., Sweetwater, TX

Mirion Technologies (Canberra) Inc., Meriden, CT

Mirion Technologies (MGPi H&B) GmbH, (Mirion Technologies), Munich, Germany

Mirion Technologies, Inc., (Sensing Systems Div.), Atlanta, GA

ORTEC, Oak Ridge, TN

◆ OTEK Corp., Tucson, AZ

◆ Radiation Safety & Control Services, Inc., Seabrook, NH

Technical Associates, (a Div. of US Nuclear Corp.), Canoga Park, CA

US Nuclear Corp., (Technical Associates Sub.), (Overhoff Technology Corp. Sub.), Canoga Park, CA

**69140 RateMeters-Scalers**

Advetage Solutions, El Segundo, CA

◆ Bot Engineering Ltd, Campbellville, Ontario, Canada

Environmental Restoration Group, Inc., Albuquerque, NM

General Atomics Electromagnetic Systems, San Diego, CA

Mirion Technologies (Canberra) Inc., Meriden, CT

ORTEC, Oak Ridge, TN

◆ Radiation Safety & Control Services, Inc., Seabrook, NH

Technical Associates, (a Div. of US Nuclear Corp.), Canoga Park, CA

US Nuclear Corp., (Technical Associates Sub.), (Overhoff Technology Corp. Sub.), Canoga Park, CA

ULTRA

Energy

Measurement and control solutions engineered for your success

- Reactor protection
- Neutron monitoring
- Radiation monitoring
- Temperature and pressure sensors

www.ultra.energy



## 69600 Reactor Instrumentation & Monitoring Systems

- BM Boron Monitoring Systems  
 CP Control Panels & Ancillary Equipment  
 DI Diagnostic Instrumentation  
 FM Flow Measurement Systems  
 FX Flux-Mapping Systems  
 GT Gamma Thermometers, Reactor Power Monitor  
 IC Inadequate Core Cooling (ICC) Monitoring Systems  
 IA Isotopic Analysis Systems  
 NM Neutron Monitoring Systems  
 PS Protection Systems, Reactor  
 RM Radiation Monitoring Systems  
 TS Reactor Temperature Scanning  
 RV Reactor Vessel Level Monitoring Systems  
 RS Redundant Signal Selector Systems  
 RC Rod Control/Drive Systems  
 RP Rod-Position Indication Systems  
 SP Safety Parameter Display Systems  
 SM Stability Monitoring Systems
- ANTECH Corp., Arvada, CO (IA)  
 Bertin Technologies, France (NM, RM)  
 ♦ Bot Engineering Ltd, Campbellville, Ontario, Canada (NM, PS, RM, RC)  
 Cabrera Services Inc., East Hartford, CT (RM)  
 CAEN SyS, (CAEN SpA), Viareggio, LU, Italy (FX, NM, RM)  
 Centronic Ltd., Surrey, United Kingdom (RC)  
 CM Technologies Corp., Coraopolis, PA (DI)  
 CTR Technical Services, Inc., Manitou Springs, CO (FX, NM, PS, SP)  
 ♦ Curtiss-Wright Nuclear Division, Brea, CA (CP, DI, PS, RM, RP, SP)  
 Curtiss-Wright Nuclear Division, QualTech NP, Cincinnati, OH (CP, RP)  
 Curtiss-Wright Nuclear Division, Scientech, Idaho Falls, ID (CP, DI, PS, RM, SP)  
 FCI-Fluid Components International, San Marcos, CA (FM)  
 ♦ Framatome Inc., (North American Headquarters), Lynchburg, VA (BM, CP, DI, FM, FX, IC, NM, PS, RM, RV, RC, RP, SP)  
*See advertisement on pages 6-7*  
 GE Hitachi Nuclear Energy, Wilmington, NC (CP, DI, FX, IA, NM, PS, RM, RC, RP, SP, SM)  
 General Atomics Electromagnetic Systems, San Diego, CA (RM)  
 GLSEQ, LLC, Huntsville, AL (DI, IC)  
 Health Physics Instruments, (Div. of Far West Technology), Goleta, CA (RM)  
 ♦ HI-Q Environmental Products Co., Inc., San Diego, CA (FM)  
 Incap Electronics US, Inc., California, PA (CP)  
 Kanata Electronic Services Ltd., (Div. of Shawcor Ltd.), Toronto, Ontario, Canada (CP)  
 ♦ LND, Inc., Oceanside, NY (FX, NM, RM, RV)  
 M&D Co., Ltd., Seoul, Korea (The Republic of) (DI)  
 MarShield Radiation Shielding, (Div. of Marswell Metal Industries Ltd.), Burlington, Ontario, Canada (FX)  
 Mirion Technologies (Canberra) Inc., Meriden, CT (CP, IA, NM, RM)  
 Mirion Technologies (IST Canada) ULC, (Formerly Mirion Technologies (IST Canada) Inc.), Cambridge, Ontario, Canada (BM, FX, GT, NM, RM, RV)  
 ♦ Mirion Technologies (IST) Corp., (Sensing Systems Div.), Horseheads, NY (FX, NM, RM)  
 Mirion Technologies (MGPI H&B) GmbH, (Mirion Technologies), Munich, Germany (BM, CP, DI, FX, NM, RM)  
 Mirion Technologies, Inc., (Sensing Systems Div.), Atlanta, GA (FX, NM, RM)  
 Mitsubishi Nuclear Energy Systems, Inc., (A Sub. of Mitsubishi Heavy Industries, Ltd.), Charlotte, NC (BM, CP, DI, FM, FX, GT, IC, IA, NM, PS, RM, TS, RV, RS, RC, RP, SP, SM)  
 NuSource LLC, Alexandria, VA (FM, NM, PS, RM, RV, RC)  
 ORTEC, Oak Ridge, TN (DI, IA, PS, RM)  
 ♦ OTEK Corp., Tucson, AZ (CP, DI, FM, RS)  
 Pajarito Scientific Corp., Santa Fe, NM (IA)

- ♦ Paragon Energy Solutions, (Paragon), Fort Worth, TX (CP, FM, FX, IC, NM, PS, RM, RV, RC, RP, SP)

*See advertisement on cover 4*

- Perma-Fix Environmental Services, Inc., Oak Ridge, TN (RM)  
 ♦ Photonis, Brive la Gaillarde Cedex, France (BM, FX, NM, RM)  
 Radics LLC, Kropyvnytskyi, Ukraine (DI, NM, PS, RC)  
 Rosemount Nuclear Instruments, Inc., Chanhassen, MN (FM)  
 SKODA JS a.s., Plzen, Bolevec, Czech Republic (The) (NM, PS, RC, RP)  
 Technical Associates, (a Div. of US Nuclear Corp.), Canoga Park, CA (NM, RM)  
 Temp-Pro Inc., Northampton, MA (CP)  
 THERMOCOAX Inc., Alpharetta, GA (FX, GT, NM)  
 THERMOCOAX SAS, Caligny, France (DI, FX, GT, NM, RM, TS, RV)  
 Toshiba America Energy Systems Corp., West Allis, WI (CP, DI, FM, FX, GT, IC, NM, PS, RM, RS, RC, RP, SP, SM)  
 Tyne USA Inc., Jacksonville, FL (BM, CP, DI, FM, FX, IA, NM, PS, RM, RV, SP, SM)  
 ♦ Ultra Energy, (Weed Instrument), Round Rock, TX (NM, PS, RM, RC)  
 US Nuclear Corp., (Technical Associates Sub.), (Overhoff Technology Corp. Sub.), Canoga Park, CA (NM, RM)  
 Westinghouse Electric Co. LLC, Cranberry Township, PA (BM, CP, DI, FM, FX, IC, NM, PS, RM, TS, RV, RC, RP, SP)  
 ♦ Westinghouse Electric Company LLC, (Westinghouse Parts Business), New Stanton, PA (BM, CP, DI, FM, FX, GT, IC, IA, NM, PS, RM, TS, RV, RS, RC, RP, SP, SM)

## 70600 Reactor Safety Research

- ASVAD INTL SL, Tarragona, Spain  
 ♦ Curtiss-Wright Nuclear Division, Brea, CA  
 Curtiss-Wright Nuclear Division, NETCO, Danbury, CT  
 Curtiss-Wright Nuclear Division, Scientech, Idaho Falls, ID  
 ♦ Framatome Inc., (North American Headquarters), Lynchburg, VA  
 GE Hitachi Nuclear Energy, Wilmington, NC  
 Idaho National Laboratory, Idaho Falls, ID  
 NuclearN, Phoenix, AZ  
 ♦ Oak Ridge National Laboratory, Oak Ridge, TN

*See advertisement on page 3*

- Toshiba America Energy Systems Corp., West Allis, WI  
 UxC, LLC, Roswell, GA

## 70650 Reactor Service Tools & Devices

- CM Camera (CCTV) Manipulator Tools  
 CS Component Shielding  
 CE Control Element Assembly Handling Tools  
 CR Control Rod Drive Handling Equipment  
 CP Core Plug Removal Tool  
 FT Flux Thimble Removal & Cleaning Equipment  
 LC Local Power Range Monitor (LPRM) Cutting Tools  
 LB LPRM Benders  
 LH LPRM Handling Tools  
 LS LPRM Strongbacks  
 NR Nut Runner & Handling Tool, RPV  
 RP Reactor Pool Cleaning Equipment  
 RV Reactor Vessel Cleaning Machine  
 R Retrieval Tools  
 RC Rod Control Cluster Assembly Handling Tools  
 SS Seal Surface Cleaning Equipment, RPV  
 SP Special-Purpose Tools  
 SN Stud/Nut Cleaning Equipment, RPV  
 SS Stud/Nut Removal Systems, Non-RPV  
 SR Stud Removal Systems, RPV  
 UV Under-Vessel Transfer System  
 AECON-WACHS, (U.S. Div. of Aecon Nuclear), Jackson, SC (LS, SP, SN, SS, SR)

◆ Denotes advertiser—see Index to Advertisers on pages 8–14

- ◆ **Ahlberg Cameras, Wilmington, NC (CM)**  
 ATS Industrial Automation, Inc. - Nuclear (UK), Blaby, Leicester, United Kingdom (CM, CS, NR, R, SP, SN, SS, SR)  
 ATS Industrial Automation, Inc. Nuclear (Canada), Cambridge, Ontario, Canada (CM, CS, NR, R, SP, SN, SS, SR)  
 Babcock Services, Inc., Kennewick, WA (RP, CR)
- ◆ **Brokk Inc., (Sub. of Brokk-Sweden), (Nuclear Div.), Santa Fe, NM (SP)**  
 Centronic Ltd., Surrey, United Kingdom (RC)  
 Coastel Cable Tools, Inc., East Syracuse, NY (LC, LH)
- ◆ **Curtiss-Wright Nuclear Division, Brea, CA (CS, CE, CR, LC, LB, LH, LS, NR, RC, SP, UV)**  
 Curtiss-Wright Nuclear Division, Scientech, Idaho Falls, ID (CS, CE, CR, LC, LB, LH, LS, NR, RC, SP, UV)
- ◆ **Dominion Engineering, Inc., Reston, VA (CM)**  
 E.H. Wachs, (A Div. of ITW), Lincolnshire, IL (SP)
- ◆ **Framatome Inc., (North American Headquarters), Lynchburg, VA (CM, CS, CE, CR, CP, FT, LC, LH, RP, RV, R, RC, SS, SP, SN, SR, UV)**  
 Integra Services Technologies Inc., Sarnia, Ontario, Canada (SR)  
 James Fisher Technologies, Loveland, CO (R)  
 JNT Technical Services Inc., Little Ferry, NJ (SN)  
 Lambda Technologies, (Surface Enhancement Technologies, LLC and Lambda Research, Inc.), Cincinnati, OH (SP)  
 Master-Lee Engineered Products Inc., Latrobe, PA (CM, CE, CR, FT, LC, NR, RP, RV, R, RC, SS, SP, SN, SS, SR)  
 Merrick & Company, Greenwood Village, CO (CS, CR, SP)
- ◆ **Mirion Technologies (IST) Corp., (Sensing Systems Div.), Horseheads, NY (CM)**  
 Mirion Technologies, Inc., (Sensing Systems Div.), Atlanta, GA (CM)  
 Mitsubishi Nuclear Energy Systems, Inc., (A Sub. of Mitsubishi Heavy Industries, Ltd.), Charlotte, NC (CM, CS, CE, CR, CP, FT, LC, LB, LH, LS, NR, RP, RV, R, RC, SS, SP, SN, SS, SR, UV)  
 Newton Research Labs, Inc., Renton, WA (SP)  
 Nuclear Energy Components Ltd, Hope Valley, Derbyshire, United Kingdom (RC)  
 PAR Systems, LLC, Saint Paul, MN (SP)  
 Premier Technology, Inc., Blackfoot, ID (CS)  
 PROTEM USA LLC, Evergreen, CO (SP, SS, SR)  
 Radium Inc., Waynesboro, VA (CM)  
 Robatel Technologies, LLC, Roanoke, VA (CS, CE, CR, CP, LH, R, RC, SP)
- ◆ **Thermo Scientific - CIDTEC Cameras & Imagers, (Part of Thermo Fisher Scientific), Liverpool, NY (CM)**  
 Toshiba America Energy Systems Corp., West Allis, WI (CR, RV, SP, SN, SR)  
 Tri Nuclear Corp., Troy, NY (RP)  
 Westinghouse Electric Co. LLC, Cranberry Township, PA (CE, CR, CP, FT, NR, R, RC, SS, SP, SN, SS, SR)

- BHI Energy - now Westinghouse, See listing for Westinghouse Electric Co., Cranberry Township, PA
- ◆ **Framatome Inc., (North American Headquarters), Lynchburg, VA**  
 General Atomics Electromagnetic Systems, San Diego, CA  
 Mitsubishi Nuclear Energy Systems, Inc., (A Sub. of Mitsubishi Heavy Industries, Ltd.), Charlotte, NC  
 Primm Consulting, LLC, Knoxville, TN  
 UxC, LLC, Roswell, GA  
 Westinghouse Electric Co. LLC, Cranberry Township, PA

**70920 Reactors, Space Propulsion**

- BWX Technologies, Inc., Lynchburg, VA  
 General Atomics Electromagnetic Systems, San Diego, CA  
 Nuclear-21, Waasmunster, Belgium

**71100 Recombiners**

- ◆ **Framatome Inc., (North American Headquarters), Lynchburg, VA**  
 GLSEQ, LLC, Huntsville, AL  
 Teledyne Brown Engineering, Inc., Huntsville, AL  
 Westinghouse Electric Co. LLC, Cranberry Township, PA

**71190 Records Management Systems**

- CM Configuration Management  
 DS Document Storage & Retrieval  
 DC Drawing Control  
 HP Health Physics  
 O Operations Recording  
 S Spare Parts  
 T Training

Advanced Technologies and Laboratories (ATL) International, Inc., (wholly owned sub. of Planned Systems International, Inc.), Gaithersburg, MD (DS, HP, T)

- Black & Veatch, Overland Park, KS (CM, DS, DC)
- ◆ **Boston Government Services, LLC (BGS), Oak Ridge, TN (CM, DS, DC, HP)**
- ◆ **Curtiss-Wright Nuclear Division, Brea, CA (CM, DS, DC, O, S, T)**  
 Curtiss-Wright Nuclear Division, Scientech, Idaho Falls, ID (CM, DS, DC, O, S, T)
- ◆ **Framatome Inc., (North American Headquarters), Lynchburg, VA (CM, S)**  
 GE Hitachi Nuclear Energy, Wilmington, NC (CM, DS, DC, S)  
 Global Quality Management Advisors, Lynchburg, VA (CM, DS, T)  
 GSE Workforce Solutions, Training Services, (Formerly known as Hyperspring), Columbia, MD (CM)  
 ISO-PACIFIC Remediation Technologies, Inc., Richland, WA (HP)  
 Mirion Technologies (Canberra) Inc., Meriden, CT (HP)  
 Mirion Technologies, Inc., (Sensing Systems Div.), Atlanta, GA (HP)  
 North Wind Group, Idaho Falls, ID (CM, HP)  
 Numerical Advisory Solutions, LLC, Cary, NC (CM, DS, DC)  
 The Delphi Group, Inc., Austin, TX (CM, HP, T)
- ◆ **WMG, Inc., Peekskill, NY (T)**

**71500 Refrigeration**

- Ellis & Watts Global Industries, Inc., (a sub. of Marmon\*, a Berkshire Hathaway company), Batavia, OH
- ◆ **James C. White Company, Inc., Greenville, SC**  
 PMT Nuclear, Woodridge, IL
- ◆ **Westinghouse Electric Company LLC, (Westinghouse Parts Business), New Stanton, PA**

**71700 Refueling Services**

- AECON-WACHS, (U.S. Div. of Aecon Nuclear), Jackson, SC

**70660 Reactors, Gen IV**

- BWX Technologies, Inc., Lynchburg, VA  
 Equipos Nucleares, S.A., S.M.E. Maliaño (Cantabria), Spain  
 Grecheck Consulting LLC, Midlothian, VA  
 Hybrid Power Technologies LLC, Overland Park, KS  
 Nuclear-21, Waasmunster, Belgium

**70665 Reactors, Gen IV/Smart & Resilient**

- BWX Technologies, Inc., Lynchburg, VA  
 Grecheck Consulting LLC, Midlothian, VA  
 Hybrid Power Technologies LLC, Overland Park, KS  
 Nuclear-21, Waasmunster, Belgium  
 Power Generation Integrated, (PGICL), Etobicoke, Ontario, Canada

**70670 Reactors, Heating**

- THERMOCOAX Inc., Alpharetta, GA  
 THERMOCOAX SAS, Caligny, France

**70900 Reactors, Research & Training**

- Arkitek Scientific, Paso Robles, CA

**40 YEARS OF RADIATION RESISTANT COLOR CAMERA EXPERIENCE**

- Lights
- CCTVs
- Cameras
- Operator stations
- Customized systems

High-quality products and systems with the latest technology for all types of nuclear reactors and nuclear waste facilities.

us@ahlbergcameras.com



BHI Energy - now Westinghouse, See listing for Westinghouse Electric Co., Cranberry Township, PA

- ◆ Curtiss-Wright Nuclear Division, Brea, CA
- Curtiss-Wright Nuclear Division, Scientech, Idaho Falls, ID
- ◆ Framatome Inc., (North American Headquarters), Lynchburg, VA
- GE Hitachi Nuclear Energy, Wilmington, NC
- Mitsubishi Nuclear Energy Systems, Inc., (A Sub. of Mitsubishi Heavy Industries, Ltd.), Charlotte, NC
- Sonic Systems International, LLC, Houston, TX
- Westinghouse Electric Co. LLC, Cranberry Township, PA

### 71900 Regulators, Air Pressure

- Energy Steel, Rochester Hills, MI
- ◆ Paragon Energy Solutions, (Paragon), Fort Worth, TX
- Tyne USA Inc., Jacksonville, FL
- ◆ Valcor Engineering Corp., (Valcor Nuclear Div.), Springfield, NJ
- ◆ Westinghouse Electric Company LLC, (Westinghouse Parts Business), New Stanton, PA

### 72000 Regulators, Feedwater

- GE Hitachi Nuclear Energy, Wilmington, NC
- ◆ Westinghouse Electric Company LLC, (Westinghouse Parts Business), New Stanton, PA

### 72300 Remote Control, Handling & Positioning Devices & Sys.

- AI Artificial Intelligence/Expert Systems
- EE End Effectors, Grippers, & Wrists
- RC Remote Control
- RH Remote Handling
- RP Remote Positioning
- RO Robotics
- TM Telescoping Masts

- Advanced Consulting Group, Inc., Chicago, IL (EE, RC, RO)
- ARES Security Corp., Vienna, VA (AI, EE, RC, RH, RP, RO, TM)
- ATS Industrial Automation, Inc. - Nuclear (UK), Blaby, Leicester, United Kingdom (EE, RC, RH, RP, RO)
- ATS Industrial Automation, Inc. Nuclear (Canada), Cambridge, Ontario, Canada (EE, RC, RH, RP, RO)
- Aurum Technologies, Blackfoot, ID (AI)
- Bilfinger Noell GmbH, (Dept. BEV), Wuerzburg, Germany (EE, RC, RH, RP)
- Brokk AB, Skelleftea, Sweden (EE, RC, RH, RP, RO)
- ◆ Brokk Inc., (Sub. of Brokk-Sweden), (Nuclear Div.), Santa Fe, NM (RC, RH, RP, RO)
- Central Research Laboratories, Red Wing, MN (EE, RC, RH, RP)
- ◆ Curtiss-Wright Nuclear Division, Brea, CA (RC, RH, RP)
- Curtiss-Wright Nuclear Division, Scientech, Idaho Falls, ID (RC, RH, RP)
- E.H. Wachs, (A Div. of ITW), Lincolnshire, IL (RC)
- ◆ Framatome Inc., (North American Headquarters), Lynchburg, VA (AI, RC, RH, RP, RO)
- GE Hitachi Nuclear Energy, Wilmington, NC (RC, RH, RO)
- Haption, New York, NY (RC, RH)
- Hot Cell Services Corp., (HCS Corp.), Kent, WA (RH)
- ISO-PACIFIC Remediation Technologies, Inc., Richland, WA (AI, RC)
- James Fisher Technologies, Loveland, CO (EE, RC, RH, RP, RO)
- JSM Protective, Inc., Port St. Lucie, FL (RH)
- Konecranes Nuclear Equipment & Services LLC, (Formerly Morris Material Handling / P&H), New Berlin, WI (RC, RH, RP, RO, TM)
- KUKA Systems UK Ltd, Halesowen, West Midlands, United Kingdom (RH, RO)
- M&D Co., Ltd., Seoul, Korea (The Republic of) (RO)

- Master-Lee Engineered Products Inc., Latrobe, PA (EE, RH)
- Merrick & Company, Greenwood Village, CO (RC, RH, RP, RO)
- Mirion Technologies, Inc., (Sensing Systems Div.), Atlanta, GA (RC, RP)
- Mitsubishi Nuclear Energy Systems, Inc., (A Sub. of Mitsubishi Heavy Industries, Ltd.), Charlotte, NC (AI, EE, RC, RH, RP, RO)
- NuVision-HWM, (Wälischmiller Engineering), Pittsburgh, PA (AI, EE, RC, RH, RP, RO)
- PAR Systems, LLC, Saint Paul, MN (AI, EE, RC, RH, RP, RO, TM)
- ◆ Preferred Engineering Corp., (Sub. of Preferred Utilities Mfg. Corp.), Danbury, CT (RH, RP)
- Radium Inc., Waynesboro, VA (AI, EE, RC, RH, RP, RO)
- ◆ Remote Ocean Systems (ROS), San Diego, CA (RC, RP)
- Robatel Technologies, LLC, Roanoke, VA (RC, RH, RP, RO)
- SERCO USA, Evergreen, CO (RC, RH, RP, RO)
- Sidus Solutions LLC, San Diego, CA (RP)
- Siempelkamp NIS, Alzenau, Germany (RC, RH, RP)
- Southwest Research Institute, San Antonio, TX (EE, RC, RH, RP, RO)
- Toshiba America Energy Systems Corp., West Allis, WI (AI, RO)
- Tri Nuclear Corp., Troy, NY (RH)
- ◆ Underwater Construction Corp., (Underwater Construction Corp. UK Ltd.), Essex, CT (RC, RH, RP, RO)
- University of Bristol, (Interface Analysis Centre) (South West Nuclear Hub), Bristol, United Kingdom (RO)
- Veolia Nuclear Solutions - Federal Services, Piketon, OH (RC, RH, RP, RO)
- ◆ Wagstaff Applied Technologies, Spokane, WA (EE, RC, RH, RP, RO)
- Wälischmiller Engineering GmbH, Markdorf, Baden-Wuerttemberg, Germany (EE, RC, RH, RO)

# ROS Introduces Compact, High Resolution, High Rad IP-LINK™ Inspection System

The IP-LINK™ Inspection System is a compact, user-friendly design that features a high resolution 1080P PTZ GENII color camera and an IP-LINK™ controller that enables the user to control the underwater PTZ GENII camera as well as view inspection video.

**The new GENII 1080p HDTV PTZ Camera is lighter and smaller and allows easier maneuverability during nuclear pool inspections.**

The Joystick control enables fast, easy zoom, focus and exposure; dual light command functions. The controller has ethernet control/video streaming as well as control of the ROS PTZ GENII camera. Dose Rate 1 kR / hour.



For more information on the IP-LINK™ System contact [sales@rosys.com](mailto:sales@rosys.com) or visit [www.rosys.com](http://www.rosys.com)

## ♦ Denotes advertiser—see Index to Advertisers on pages 8–14

Westinghouse Electric Co. LLC, Cranberry Township, PA (EE)

♦WGMG, Inc., Peekskill, NY (EE, RH)

### 73300 Remote-Viewing Instruments & Systems

BI Binoculars  
 BF Borescopes, Flexible  
 BR Borescopes, Rigid  
 D Drones  
 I Infrared  
 M Monocular Scopes, Viewing/ALARA  
 P Periscopes  
 RR Radiation-Resistant  
 S Submersible  
 T Telescopes  
 U Unmanned Vehicles

- ♦Alphasource, Inc., Philadelphia, PA (BF, BR)  
 ATS Industrial Automation, Inc. - Nuclear (UK), Blaby, Leicester, United Kingdom (RR, U)  
 ATS Industrial Automation, Inc. Nuclear (Canada), Cambridge, Ontario, Canada (RR, U)  
 Centronic Ltd., Surrey, United Kingdom (P, RR, S)  
 Coastal Network, Inc., Charlottesville, VA (M)  
 DETEK, Temple Hills, MD (BF, BR)  
 Environmental Restoration Group, Inc., Albuquerque, NM (D, U)  
 Evident Scientific, Inc., (Evident Corp.), Webster, TX (BF, BR)  
 ♦Framatome Inc., (North American Headquarters), Lynchburg, VA (S)  
 GE Hitachi Nuclear Energy, Wilmington, NC (I, M, RR, S)  
 GenScope, Inc., East Longmeadow, MA (BF, BR)  
 Hopewell Designs, Inc., Alpharetta, GA (BF, BR)  
 Hot Cell Services Corp., (HCS Corp.), Kent, WA (RR)  
 ISO-PACIFIC Remediation Technologies, Inc., Richland, WA (S)  
 James Fisher Technologies, Loveland, CO (S, T)  
 Lenox Instrument Co., Inc., Trevoise, PA (BF, BR, P, RR)  
 ♦Mirion Technologies (IST) Corp., (Sensing Systems Div.), Horseheads, NY (RR, S)  
 Mirion Technologies, Inc., (Sensing Systems Div.), Atlanta, GA (RR, S, T)  
 Mitsubishi Nuclear Energy Systems, Inc., (A Sub. of Mitsubishi Heavy Industries, Ltd.), Charlotte, NC (BI, BF, BR, I, M, P, RR, S, T)  
 Newton Research Labs, Inc., Renton, WA (S)  
 NuVision-HWM, (Wälischmiller Engineering), Pittsburgh, PA (RR, S)  
 PAR Systems, LLC, Saint Paul, MN (T)  
 Radium Inc., Waynesboro, VA (RR, S)  
 ♦Remote Ocean Systems (ROS), San Diego, CA (S)  
 Sidus Solutions LLC, San Diego, CA (I, S)  
 Skydio, San Mateo, CA (D)  
 ♦Thermo Scientific - CIDTEC Cameras & Imagers, (Part of Thermo Fisher Scientific), Liverpool, NY (RR)  
 Toshiba America Energy Systems Corp., West Allis, WI (I, S)

### 73350 Reprocessing Equipment, Fuel

Fuel Tank Maintenance Co., LLC, Cookeville, TN  
 Merrick & Company, Greenwood Village, CO  
 Orano USA, Bethesda, MD  
 ♦Precision Custom Components, LLC., (DC Fabricators), York, PA  
 Robatel Technologies, LLC, Roanoke, VA  
 Rousselet-Robatel, Pittsfield, MA

### 73400 Reprocessing, Fuel

Fuel Tank Maintenance Co., LLC, Cookeville, TN  
 Nuclear-21, Waasmunster, Belgium  
 ♦Oak Ridge National Laboratory, Oak Ridge, TN  
 Orano USA, Bethesda, MD  
 Primm Consulting, LLC, Knoxville, TN  
 Robatel Technologies, LLC, Roanoke, VA  
 UxC, LLC, Roswell, GA

### 73450 Research Services, Nuclear

Black & Veatch, Overland Park, KS  
 BWX Technologies, Inc., Lynchburg, VA  
 CTR Technical Services, Inc., Manitou Springs, CO  
 ♦Curtiss-Wright Nuclear Division, Brea, CA  
 Curtiss-Wright Nuclear Division, Scientech, Idaho Falls, ID

DCS Systems, Inc., Simsbury, CT  
 Deytec, Inc., Ashburn, VA

- ♦Dominion Engineering, Inc., Reston, VA  
 ♦Framatome Inc., (North American Headquarters), Lynchburg, VA  
 Gamma Reality Inc., Richmond, CA  
 GE Hitachi Nuclear Energy, Wilmington, NC  
 Kinectrics Inc., Toronto, Ontario, Canada  
 Mirion Technologies (Canberra) Inc., Meriden, CT  
 NSSI/Recovery Services Inc., Houston, TX  
 Nuclear-21, Waasmunster, Belgium  
 ♦Oak Ridge National Laboratory, Oak Ridge, TN  
 OECD Nuclear Energy Agency (NEA), Paris, France  
 Prospect Law Ltd., London, United Kingdom  
 ♦Radiation Safety & Control Services, Inc., Seabrook, NH  
 Tetra Tech Inc., Richland, WA  
 Toshiba America Energy Systems Corp., West Allis, WI  
 TransWare Enterprises Inc., St. Louis, MO  
 University of Bristol, (Interface Analysis Centre) (South West Nuclear Hub), Bristol, United Kingdom  
 UxC, LLC, Roswell, GA

### 73550 Respiratory Protection Equipment

AP Air Purification Systems  
 B Breathing Air Testing  
 C Compressors  
 FT Fit-Testing Systems  
 RC Respirator Cleaning Systems  
 RD Respirator Drying Systems  
 RL Respirators, Air-Line  
 R Respirators, Air-Purifying  
 RX Respirators, Combination Type  
 RP Respirators, Powered Air-Purifying  
 RE Resuscitators  
 SC Self-Contained Breathing Apparatus  
 SB SCBA Boost Pumps  
 SE SCBA (Escape)  
 SF SCBA Filling Stations  
 ST SCBA Flow Testing & Services  
 SW SCBA Software  
 SS Storage Systems (Cleaned Equipment)  
 V Vessels, High-Pressure, Air

- ♦Framatome Inc., (North American Headquarters), Lynchburg, VA (AP, C)  
 ♦Fram Safety Products, Inc., Rock Hill, SC (AP, C, FT, RC, RD, RL, R, RX, RP, SC, SB, SE, SF, ST, SW, SS)  
 James Fisher Technologies, Loveland, CO (C)  
 JSM Protective, Inc., Port St. Lucie, FL (AP, RL, R, RX, RP, SC)  
 Lancs Industries, Albuquerque, NM (RL)  
 Mitsubishi Nuclear Energy Systems, Inc., (A Sub. of Mitsubishi Heavy Industries, Ltd.), Charlotte, NC (AP, C, FT, RC, RD, RL, R, RX, RP, RE, SC, SB, SE, SF, ST, SW, SS, V)  
 Mohawk Safety, Inc., Manchester, CT (RL, R, RP, SC)  
 Nexttek International LLC, Tampa, FL (FT)  
 ♦NUCON International, Inc., Columbus, OH (AP, FT)  
 Radium Inc., Waynesboro, VA (AP, R, RX, RP)  
 Scientific Sales, Inc., Oak Ridge, TN (AP, B, C, FT, RC, RD, RL, R, RX, RP, RE, SC)  
 UniTech Services Group Europe, (Sub. of UniTech Services Group USA), Coevorden, Netherlands (The) (RL, R, RX, RP, SC, SE, ST, SS)  
 ♦UniTech Services Group, Inc., (Div. of UniFirst Corp.), Longmeadow, MA (C, RC, RD, RL, R, RX, SS)

### 73570 Rigging Specialists

- ♦American DND Inc., Grand Island, NY  
 ♦Barnhart Nuclear Services, Fairhope, AL  
 BHI Energy - now Westinghouse, See listing for Westinghouse Electric Co., Cranberry Township, PA  
 Carolina Fabricators, West Columbia, SC  
 CS-2 Inc., Grand Island, NY  
 Cutting Technologies (CTI), Gloucester City, NJ  
 Dufrane Nuclear Shielding Inc., (Dufrane Nuclear Inc.), Winsted, CT  
 E.S. Fox Limited, Niagara Falls, Ontario, Canada  
 Engineered Rigging, Russellville, AR

Sarens Nuclear & Industrial Services LLC, (Sarens), Houston, TX  
 Westinghouse Electric Co. LLC, Cranberry Township, PA

### 73590 Rings, Retaining

- Carolina Fabricators, West Columbia, SC  
 Cross Manufacturing Co. (1938) Ltd., Bath, United Kingdom  
 ♦Curtiss-Wright Nuclear Division, Brea, CA  
 Curtiss-Wright Nuclear Division, Nova, Middleburg Heights, OH  
 ♦DuBoise National Energy Services, Inc., Clinton, NC

### 73620 Robotic Devices, Systems

- CA CAD-Driven  
 C Condenser, In-Service Inspection  
 FT Force/Torque Sensors  
 N Nuclear  
 RV Reactor Vessel Head, ISI  
 S Submersible  
 ARES Security Corp., Vienna, VA (CA, N)  
 ATS Industrial Automation, Inc. - Nuclear (UK), Blaby, Leicester, United Kingdom (CA, C, FT, RV, S)  
 ATS Industrial Automation, Inc. Nuclear (Canada), Cambridge, Ontario, Canada (CA, C, FT, RV, S)  
 ♦AVANTech, LLC, Columbia, SC (S)  
 Baker Industries, a Lincoln Electric Company, Macomb, MI (CA)  
 Bilfinger Noell GmbH, (Dept. BEV), Wuerzburg, Germany (RV)  
 Brokk AB, Skelleftea, Sweden (RV)  
 ♦Brokk Inc., (Sub. of Brokk-Sweden), (Nuclear Div.), Santa Fe, NM (CA)  
 Constellation ClearSight, De Pere, WI (C)  
 ♦Curtiss-Wright Nuclear Division, Brea, CA (N, RV)  
 Curtiss-Wright Nuclear Division, Anatec, Brea, CA (RV)  
 ♦Framatome Inc., (North American Headquarters), Lynchburg, VA (RV, S)  
 James Fisher Technologies, Loveland, CO (FT, N, S)  
 Kinectrics Inc., Toronto, Ontario, Canada (CA, N)  
 KUKA Systems UK Ltd, Halesowen, West Midlands, United Kingdom (N)  
 Merrick & Company, Greenwood Village, CO (CA)  
 NuVision-HWM, (Wälischmiller Engineering), Pittsburgh, PA (RV, S)  
 ♦Oak Ridge National Laboratory, Oak Ridge, TN (N)  
 PAR Systems, LLC, Saint Paul, MN (CA, N, S)  
 Radium Inc., Waynesboro, VA (FT, S)  
 Southwest Research Institute, San Antonio, TX (N, RV, S)  
 Teledyne Brown Engineering, Inc., Huntsville, AL (FT)  
 ♦Thermal Engineering International (TEI), Cerritos, CA (C)  
 Toshiba America Energy Systems Corp., West Allis, WI (C, FT, S)  
 Veolia Nuclear Solutions - Federal Services, Piketon, OH (CA, FT, N, S)  
 Wälischmiller Engineering GmbH, Markdorf, Baden-Württemberg, Germany (CA, C, FT, N, S)

### 73720 Rubber Lining Services

Corrosion Control Services, Inc., Davenport, IA  
 PMT Nuclear, Woodridge, IL

### 73730 Rupture Disks, Safety Heads

Tioga Pipe, Philadelphia, PA

### 73750 Rust Removers

Arkema, Inc., (formerly ATOFINA Chemicals, Inc.), King of Prussia, PA  
 Desco Mfg. Co., Inc., Rancho Santa Margarita, CA

### 73770 Safeguard Systems

- ARES Security Corp., Vienna, VA  
 ♦Bot Engineering Ltd, Campbellville, Ontario, Canada  
 CAEN SyS, (CAEN SpA), Viareggio, LU, Italy

Mirion Technologies (Canberra) Inc., Meriden, CT  
 Nuclear-21, Waasmunster, Belgium  
 ORTEC, Oak Ridge, TN  
 Right Brain Sekurity, Oswego, IL

**73790 Safes**

I Isotope  
 T Thermoluminescent Dosimeter (TLD)  
 J. L. Shepherd & Assoc., San Fernando, CA (I)

**73900 Sample Changers**

Hopewell Designs, Inc., Alpharetta, GA  
 Mirion Technologies (Canberra) Inc., Meriden, CT  
 US Nuclear Corp., (Technical Associates Sub.), (Overhoff Technology Corp. Sub.), Canoga Park, CA

**73950 Sample Coolers**

♦Aerofin, Lynchburg, VA  
 Ellis & Watts Global Industries, Inc., (a sub. of Marmon\*, a Berkshire Hathaway company), Batavia, OH  
 ♦Super Radiator Coils, Chaska, MN

**74150 Samplers & Sampling Systems**

A Air (Carried by Personnel)  
 AP Air Particulate  
 AS Automatic Systems  
 EC Evaporator Concentrate  
 G Gas  
 I Iodine  
 L Liquid  
 M Metallurgical  
 RT Real-Time Remote  
 SS Stack Sampling  
 W Waste  
 ANTECH Corp., Arvada, CO (AS)  
 ♦AVANTech, LLC, Columbia, SC (G, L, W)  
 Berthold Technologies USA LLC, Oak Ridge, TN (AP, AS, G, I, RT, SS, W)

Coastal Network, Inc, Charlottesville, VA (AP)  
 ♦EnergySolutions, Salt Lake City, UT (AP)  
 ♦F&J SPECIALTY PRODUCTS, INC., Ocala, FL (A, AP, G, I, L, RT, SS)  
 ♦Framatome Inc., (North American Headquarters), Lynchburg, VA (AS, G, L)  
 ♦Fram Safety Products, Inc., Rock Hill, SC (A, AP, AS)  
 GE Hitachi Nuclear Energy, Wilmington, NC (AP, AS, G, L)  
 General Atomics Electromagnetic Systems, San Diego, CA (AP, G, I, L, SS)  
 ♦HI-Q Environmental Products Co., Inc., San Diego, CA (A, AP, AS, G, I, SS)  
 ISO-PACIFIC Remediation Technologies, Inc., Richland, WA (M)  
 ♦LND, Inc., Oceanside, NY (AS)  
 Mirion Technologies (Canberra) Inc., Meriden, CT (AP, AS, G, I, L, RT, SS)  
 Mirion Technologies (MGPI H&B) GmbH, (Mirion Technologies), Munich, Germany (AP, I, SS)  
 Mirion Technologies, Inc., (Sensing Systems Div.), Atlanta, GA (AP, I, SS)  
 Mound Technical Solutions, Inc., Miamisburg, OH (SS)  
 Nextteq International LLC, Tampa, FL (A, G, L, SS)  
 ORTEC, Oak Ridge, TN (AP, AS)  
 Pajarito Scientific Corp., Santa Fe, NM (SS)  
 Pylon Electronics Inc., (Instrument Manufacturing Div.), Ottawa, Ontario, Canada (G, RT)  
 Radiological Solutions Inc., Rockdale, IL (L)  
 ReNuke, Oak Ridge, TN (A, AP)  
 SGS North America Inc., Vallejo, CA (L)  
 Staplex - Air Sampler Div., Brooklyn, NY (A, AP)  
 Technical Associates, (a Div. of US Nuclear Corp.), Canoga Park, CA (A, AP, AS, EC, G, I, L, RT, SS)  
 Teledyne Brown Engineering, Inc., Huntsville, AL (SS)  
 Toshiba America Energy Systems Corp., West Allis, WI (G, I, L, SS)

Blue text indicates an advertiser within the category

♦UniTech Services Group, Inc., (Div. of UniFirst Corp.), Longmeadow, MA (A, AP)  
 US Nuclear Corp., (Technical Associates Sub.), (Overhoff Technology Corp. Sub.), Canoga Park, CA (AP, AS, G, I, L)

**74320 Sampling Systems Services**

♦Curtiss-Wright Nuclear Division, Brea, CA  
 Curtiss-Wright Nuclear Division, Scientech, Idaho Falls, ID  
 Encorus Group, Springville, NY  
 ♦Framatome Inc., (North American Headquarters), Lynchburg, VA  
 Fuel Tank Maintenance Co., LLC, Cookeville, TN  
 GE Hitachi Nuclear Energy, Wilmington, NC  
 GLSEQ, LLC, Huntsville, AL  
 ♦HI-Q Environmental Products Co., Inc., San Diego, CA  
 ISO-PACIFIC Remediation Technologies, Inc., Richland, WA  
 Kinectrics Inc., Toronto, Ontario, Canada  
 New Millennium Nuclear Technologies International, Lakewood, CO

**74350 Scaffolding**

C Conventional  
 M Modular  
 SP Scaffold Plank  
 S Suspended Type  
 T Tube & Clamp Type  
 Advanced Nuclear LLC, Aston, PA (C, M, SP, S, T)  
 Baker Industries, a Lincoln Electric Company, Macomb, MI (C, M, SP, S, T)  
 BHI Energy - now Westinghouse, See listing for Westinghouse Electric Co., Cranberry Township, PA (C, M, SP, S)  
 Carolina Fabricators, West Columbia, SC (C, M, SP, T)  
 Westinghouse Electric Co. LLC, Cranberry Township, PA (C, M, SP, S)

**HI-Q ENVIRONMENTAL PRODUCTS COMPANY, INC.**  
 Air Sampling & Radiation Monitoring Equipment, Systems & Accessories

**Air Flow Calibrators**

**Filter Holders and Filter Media**

**Health Physics & Radiation Measurement Instrumentation**

**Mobile Cart Air Samplers**

**ANSI N13.1-2011 Stack Sampling Location Qualification Testing & System Design**

**Continuous Duty High & Low Volume Air Samplers**

Our product line also includes:  
 • Calibration & Repair Services  
 • Silver Zeolite Cartridges  
 • Filter Paper  
 • Filter Holders (In-Line, Open Faced, Combination)  
 • Outdoor Ambient Air Samplers & Shelters  
 • Custom Product & System Design  
 • TEDA Impregnated Carbon Cartridges

7386 Trade Street | San Diego, CA 92121  
 Phone: 858-549-2820 | Fax: 858-549-9657  
 Email: info@HI-Q.net | Internet: www.HI-Q.net



# F&J Advanced Technology Instruments



**DFHV-1V.2**  
Digital Flow Meter  
Portable High Volume  
Air Sampler



**DFCB-100L-400-12Li**  
12 Ah LiFePO<sub>4</sub>  
Emergency Response Air Sampler  
Ruggedized Enclosure



**DFCP-ABM50-75L-20Li**  
20 Ah LiFePO<sub>4</sub>  
AC/DC/ Battery  
Emergency Response Air Sampler



**GAS-60810DT**  
TSP Ambient  
Air Sampling System  
(8" x 10" Filter)



**RICF**  
Radioiodine Collection Filter Cartridges



**Filter Media**  
MCE Membrane Assortment, Glass  
Fiber, Qualitative and Quantitative



**GAS-22-D**  
Modern Technology  
Low Volume REMP  
Air Sampling System



## F&J SPECIALTY PRODUCTS, INC.

The Nucleus of Quality Air Monitoring Programs

Tel: 352.680.1177 / Fax: 352.680.1454 / Email: [fandj@fjspecialty.com](mailto:fandj@fjspecialty.com) / [www.fjspecialty.com](http://www.fjspecialty.com)

**74400 Scalars**

- Advantage Solutions, El Segundo, CA
- ◆ Bot Engineering Ltd, Campbellville, Ontario, Canada
  - Ludlum Measurements, Inc., Sweetwater, TX
  - Mirion Technologies (Canberra) Inc., Meriden, CT
  - ORTEC, Oak Ridge, TN
  - ◆ Radiation Safety & Control Services, Inc., Seabrook, NH
  - US Nuclear Corp., (Technical Associates Sub.), (Overhoff Technology Corp. Sub.), Canoga Park, CA

**74600 Scales, Weighing, Nuclear**

- CW Cellular Weighing  
 LT Lift Truck  
 OC Overhead Crane  
 TD Tension Dynamometers  
 WW Wheel Weighers
- ◆ Barnhart Nuclear Services, Fairhope, AL (OC)

**75000 Scintillation Glasses**

JSM Protective, Inc., Port St. Lucie, FL

**75100 Scintillation Plastics**

Berthold Technologies USA LLC, Oak Ridge, TN  
 JSM Protective, Inc., Port St. Lucie, FL  
 Ludlum Measurements, Inc., Sweetwater, TX

**75190 Seals**

- CM Ceramic-Metal Assemblies  
 CS Conduit Seal  
 ES Equipment Storage Pool  
 FG Flat Gasketing  
 GR Flat Gasketing, Radiation-Resistant  
 FT Flux Thimble Seal  
 H Hydraulic  
 I Inflatable  
 IP Inspection Port  
 MS Mechanical, Shaft  
 MP Mechanical, Shaft, Reactor Circulating Pump  
 M Metal (O-Rings, C-Rings, etc.)  
 NI Nuclear Instrumentation Cover  
 P Penetration  
 RC Reactor Cavity Pool  
 SR Sealing Systems, Compressed Rubber  
 SS Sealing Systems, Fluid
- Adam Brown Consulting, Inc., Cary, IL (P)  
 ◆ Alphasource, Inc., Philadelphia, PA (I)  
 Basic E, Inc., Charlotte, VT (FG)  
 Centronic Ltd., Surrey, United Kingdom (CM)  
 Cross Manufacturing Co. (1938) Ltd., Bath, United Kingdom (MS, M)  
 ◆ Curtiss-Wright Nuclear Division, Brea, CA (CM, ES, FG, GR, H, I, IP, MS, MP, M, NI, P, RC, SR, SS)  
 Curtiss-Wright Nuclear Division, AP Services, Middleburg Heights, OH (CM, FG, GR, H, MS, MP, SR, SS)  
 Curtiss-Wright Nuclear Division, QualTech NP, Cincinnati, OH (FG, GR, H, I, MS, M, P)  
 Curtiss-Wright Nuclear Division, Scientech, Idaho Falls, ID (ES, H, I, IP, NI, P, RC, SR, SS)  
 Electrical Builders Inc. (EBI), St. Cloud, MN (FG, IP)  
 Electro Static Technology, Mechanic Falls, ME (MS, MP)  
 Energy Steel, Rochester Hills, MI (FG, MS, MP, M)  
 ◆ Framatome Inc., (North American Headquarters), Lynchburg, VA (I, MS, MP, M, P, RC, SS)  
 Hot Cell Services Corp., (HCS Corp.), Kent, WA (FG, GR, SR)  
 JETSEAL, Inc., Spokane Valley, WA (M, SS)  
 KSB, Inc., Henrico, VA (MS, MP)  
 ◆ Mirion Technologies (IST) Corp., (Sensing Systems Div.), Horseheads, NY (CM, P)  
 Mirion Technologies, Inc., (Sensing Systems Div.), Atlanta, GA (CM, P)  
 ◆ Paragon Energy Solutions, (Paragon), Fort Worth, TX (MS)  
 Piping Technology & Products, Inc., Houston, TX (P)  
 PMT Nuclear, Woodridge, IL (FG, GR, MS)

- ◆ Preferred Engineering Corp., (Sub. of Preferred Utilities Mfg. Corp.), Danbury, CT (ES, GR, I, IP, NI, P, RC, SR)
- ◆ Presray Corp., (Div. of Pawling Corp.) (Critical Containment Solutions), Wassauc, NY (I)
- Sulzer Pumps (US) Inc., Chattanooga, TN (MS, MP)
- Technetics Group Columbia, (an EnPro Company), Columbia, SC (M, SS)
- The Perma-Type Company, Inc., Plainville, CT (I)
- ◆ Thermal Engineering International (TEI), Cerritos, CA (FG)
- Tyne USA Inc., Jacksonville, FL (NI)
- Westinghouse Electric Co. LLC, Cranberry Township, PA (MS, MP, M, P, RC)
- ◆ Westinghouse Electric Company LLC, (Westinghouse Parts Business), New Stanton, PA (CM, ES, FG, GR, H, I, IP, MS, MP, M, NI, P, RC, SR, SS)

**75500 Security Enforcement Products**

Aegis, LLC, Ooltewah, TN  
 ARES Security Corp., Vienna, VA  
 EK USA, Inc., (EK Eccessories, Inc.), Logan, UT  
 NETCo, Windsor, ME

**75550 Security for Emergencies & Evacuation**

ARES Security Corp., Vienna, VA

**75600 Security Services**

- A Analysis  
 C Cybersecurity  
 D Drug Testing  
 E Engineering  
 G Guards  
 P Plan Design  
 SI Screening & Investigation
- ARES Security Corp., Vienna, VA (A, E, P, SI)  
 BHI Energy - now Westinghouse, See listing for Westinghouse Electric Co., Cranberry Township, PA (SI)
- ◆ Boston Government Services, LLC (BGS), Oak Ridge, TN (A, E)
  - Brownstone Psychological Associates, Manitowoc, WI (SI)
  - Burns & McDonnell, Kansas City, MO (A, E, SI)
  - Confidential Services, Inc., South Haven, MI (SI)
  - ◆ Curtiss-Wright Nuclear Division, Brea, CA (A)
  - Curtiss-Wright Nuclear Division, Scientech, Idaho Falls, ID (A)
  - ◆ EXCEL Services Corporation, Rockville, MD (A)
  - ◆ Framatome Inc., (North American Headquarters), Lynchburg, VA (A, E)
  - GE Hitachi Nuclear Energy, Wilmington, NC (A)
  - Idaho National Laboratory, Idaho Falls, ID (A, E)
  - Imperia Engineering Partners LLC, Milford, MA (A, E)
  - Jensen Hughes, Baltimore, MD (A, C, E, P)
  - Merrick & Company, Greenwood Village, CO (E)
  - NETCo, Windsor, ME (P, SI)
  - Numerical Advisory Solutions, LLC, Cary, NC (E)
  - Right Brain Security, Oswego, IL (A, E)
  - Rohde & Schwarz USA, Inc., Columbia, MD (SI)
  - Southwest Research Institute, San Antonio, TX (C)
  - Tetra Tech Inc., Richland, WA (E)
  - United Engineers & Constructors, Inc., (Sub. of Imperia Engineering Partners), Mount Laurel, NJ (E)
  - Westinghouse Electric Co. LLC, Cranberry Township, PA (SI)

**75700 Security Structures**

BW Barbed Wire, Tape  
 BG Barrier-Gates  
 F Fences  
 GO Gate Operators  
 G Gates  
 GS Guard Stations  
 GB Gunports, Bullet-Resistant  
 L Lockers, Weapon Storage  
 SB Security Booths (Man-Trap)  
 T Turnstiles  
 WP Wall Panels, Bullet-Resistant  
 WB Windows, Bullet-Resistant  
 AECON-WACHS, (U.S. Div. of Aeccon Nuclear), Jackson, SC (G, GS)

- Aegis, LLC, Ooltewah, TN (WP)  
 Container Technologies Industries, LLC, Helenwood, TN (BG, GS, GB, WP, WB)  
 ◆ Curtiss-Wright Nuclear Division, Brea, CA (BG, GO, G, WP, WB)  
 Curtiss-Wright Nuclear Division, QualTech NP, Cincinnati, OH (BG, GO, G, WP, WB)  
 ◆ DuBose National Energy Services, Inc., Clinton, NC (BW, BG, F)  
 Dufrane Nuclear Shielding Inc., (Dufrane Nuclear Inc.), Winsted, CT (GB, WB)  
 Fuel Tank Maintenance Co., LLC, Cookeville, TN (BW, BG, F, GO, G, GS, GB, L, SB, T, WP, WB)  
 Mirion Technologies, Inc., (Sensing Systems Div.), Atlanta, GA (I)  
 NETCo, Windsor, ME (BG)  
 Newton Security Inc., Renton, WA (SB)  
 Par-Kut International, Inc., Harrison Twp., MI (GS, SB)  
 PMT Nuclear, Woodridge, IL (BG, F)  
 ◆ Presray Corp., (Div. of Pawling Corp.) (Critical Containment Solutions), Wassauc, NY (WP, WB)  
 SecurMAR, LLC, Zionsville, IN (BG, G, GS, GB, SB)

**75850 Security Systems & Devices**

- AI Anti-Intrusion, Indoor  
 AO Anti-Intrusion, Outdoor  
 AP Asset Protection (Anti-Removal), Electronic  
 AS Automated Security Patrol Robot  
 C Computerized  
 FI Fully Integrated  
 HS Homeland Security Equipment & Services  
 ID Intruder Detection (Laser, Microwave/Infrared)  
 ET Explosives Trace Detection  
 MD Metal (Weapon) Detectors  
 NV Night Vision Scopes & Devices  
 P Personal Alarm  
 PA Personnel Access Control  
 RT Railcar, Remote Tracking & Cargo Monitoring  
 TW Thermal Weapon Sights  
 VA Vehicle Access Control  
 V Vehicles  
 VS Video Surveillance Systems (CCTV)  
 VT Video Transmission Systems  
 WI Water Intake, Anti-Intrusion  
 X X-ray Inspection Systems
- AFO Research Inc., Vero Beach, FL (MD)  
 ARES Security Corp., Vienna, VA (AI, AO, AP, AS, C, FI, HS, ID, PA, VA, VS, VT)  
 ◆ AVANTech, LLC, Columbia, SC (VS)  
 Bertin Technologies, France (PA, VA)  
 BHI Energy - now Westinghouse, See listing for Westinghouse Electric Co., Cranberry Township, PA (FI, HS, VS)  
 ◆ Curtiss-Wright Nuclear Division, Brea, CA (C, PA)  
 Curtiss-Wright Nuclear Division, Scientech, Idaho Falls, ID (C, PA)  
 EK USA, Inc., (EK Eccessories, Inc.), Logan, UT (PA)  
 ◆ Framatome Inc., (North American Headquarters), Lynchburg, VA (C)  
 Fuel Tank Maintenance Co., LLC, Cookeville, TN (AI, AO, C, FI, HS, VS)  
 K-Tek International Inc., Wilsonville, OR (AO, C, FI, HS)  
 Mirion Technologies, Inc., (Sensing Systems Div.), Atlanta, GA (C, HS, PA, VA, V)  
 NETCo, Windsor, ME (AI, AO, ID, ET, MD, WI, X)  
 Newton Security Inc., Renton, WA (AI, AO, FI, ID, PA, VA, VS)  
 ORTEC, Oak Ridge, TN (HS)  
 ◆ Radiation Safety & Control Services, Inc., Seabrook, NH (PA)  
 Radium Inc., Waynesboro, VA (VS, VT)  
 Right Brain Security, Oswego, IL (HS)  
 Rohde & Schwarz USA, Inc., Columbia, MD (PA)  
 SecurMAR, LLC, Zionsville, IN (AI, AO, MD, X)  
 Sidus Solutions LLC, San Diego, CA (AI, AO, FI, HS, ID, NV, VS, VT, WI)  
 Tetra Tech Inc., Richland, WA (HS)  
 ◆ Thermo Scientific - CIDTEC Cameras & Imagers, (Part of Thermo Fisher Scientific), Liverpool, NY (NV, VS)

♦ Denotes advertiser—see Index to Advertisers on pages 8–14

Westinghouse Electric Co. LLC, Cranberry Township, PA (FI, VS)

#### 76400 Seismic Instrumentation & Testing

- ♦ Curtiss-Wright Nuclear Division, Brea, CA  
Curtiss-Wright Nuclear Division, QualTech NP, Cincinnati, OH  
Curtiss-Wright Nuclear Division, Scientech, Idaho Falls, ID
- ♦ Element Nuclear (NTS Labs), (Nuclear Engineering & Test Services), Huntsville, AL
- ♦ Framatome Inc., (North American Headquarters), Lynchburg, VA  
GE Hitachi Nuclear Energy, Wilmington, NC  
GLSEQ, LLC, Huntsville, AL  
Kinectrics Inc., Toronto, Ontario, Canada  
Kinometrics, Inc., Pasadena, CA
- ♦ Paragon Energy Solutions, (Paragon), Fort Worth, TX  
Pylon Electronics Inc., (Instrument Manufacturing Div.), Ottawa, Ontario, Canada  
Radics LLC, Kropyvnytskyi, Ukraine  
Syscom Instruments S.A., Sainte-Croix, Switzerland  
University of Bristol, (Interface Analysis Centre) (South West Nuclear Hub), Bristol, United Kingdom  
Westinghouse Electric Co. LLC, Cranberry Township, PA
- ♦ Westinghouse Electric Company LLC, (Westinghouse Parts Business), New Stanton, PA

#### 76600 Seismic Restraints

- Carolina Fabricators, West Columbia, SC
- ♦ Element Nuclear (NTS Labs), (Nuclear Engineering & Test Services), Huntsville, AL
- ♦ Framatome Inc., (North American Headquarters), Lynchburg, VA  
GE Hitachi Nuclear Energy, Wilmington, NC  
NuSource LLC, Alexandria, VA  
Piping Technology & Products, Inc., Houston, TX  
Toshiba America Energy Systems Corp., West Allis, WI  
UCC Industries International Inc., Pickering, Ontario, Canada
- ♦ Westinghouse Electric Company LLC, (Westinghouse Parts Business), New Stanton, PA

#### 77000 Semiconductor Devices

- 3D PLUS, (Detection Systems), Versailles, France  
Basic E, Inc., Charlotte, VT  
Gamma Reality Inc., Richmond, CA  
H3D, Inc., Ann Arbor, MI  
ORTEC, Oak Ridge, TN  
Scientific Sales, Inc., Oak Ridge, TN
- ♦ Westinghouse Electric Company LLC, (Westinghouse Parts Business), New Stanton, PA

#### 77250 Sensors

A Acoustic  
FT Force & Torque  
T Temperature  
V Vibration

- ♦ Constellation PowerLabs, Coatesville, PA (A, FT, T, V)
- ♦ Curtiss-Wright Nuclear Division, Brea, CA (A, FT, T, V)  
Curtiss-Wright Nuclear Division, QualTech NP, Cincinnati, OH (A, FT, T, V)  
Electrical Builders Inc. (EBI), St. Cloud, MN (A, T, V)
- ♦ Element Nuclear (NTS Labs), (Nuclear Engineering & Test Services), Huntsville, AL (T, V)  
FCI-Fluid Components International, San Marcos, CA (T)
- ♦ Framatome Inc., (North American Headquarters), Lynchburg, VA (A, T)  
GLSEQ, LLC, Huntsville, AL (A, FT, T, V)  
KROHNE, (KROHNE Nuclear), Romans-sur-Isère, France (T)  
Mirion Technologies (IST Canada) ULC, (Formerly Mirion Technologies (IST Canada) Inc.), Cambridge, Ontario, Canada (T)

# RdF

Since 1955

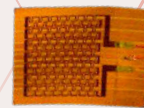

*Making sense of sensing temperature*

## Accurate. Reliable. Repeatable.

Trusted wherever temperature is critical to your success.

### Thermocouples • RTDs • Heat Flux Sensors

Safety-related and Balance of Plant RTDs & Thermocouples for Nuclear Plants.

Qualified for Environmental, Seismic, High-radiation, Accident conditions.

### RdF Engineers Solutions for:

- Reactor Performance & Efficiency Monitoring
- Power Generation and Energy Storage
- R&D, Material Studies and Building Science
- Fuel Cell and Battery Performance
- Environmental Efficiency studies... and more.



ISO 9001 & AS 9100 Registered  
NQA-1 and N299.1 Approved  
FM-Certified Explosion Proof



[www.rdfcorp.com](http://www.rdfcorp.com)

Hudson, NH USA

*From deep sea to deep space... and everywhere in between.*

- ◆ Mirion Technologies (IST) Corp., (Sensing Systems Div.), Horseheads, NY (T)
- Mirion Technologies, Inc., (Sensing Systems Div.), Atlanta, GA (T)
- NuSource LLC, Alexandria, VA (T)
- ◆ Paragon Energy Solutions, (Paragon), Fort Worth, TX (T)
- ◆ **RdF Corporation, Hudson, NH (T)**
- Syscom Instruments S.A., Sainte-Croix, Switzerland (V)
- Temp-Pro Inc., Northampton, MA (T)
- THERMOCOAX Inc., Alpharetta, GA (T, V)
- THERMOCOAX SAS, Caligny, France (T, V)
- Toshiba America Energy Systems Corp., West Allis, WI (T, V)
- ◆ Ultra Energy, (Weed Instrument), Round Rock, TX (T)
- Westinghouse Electric Co. LLC, Cranberry Township, PA (T)
- ◆ Westinghouse Electric Company LLC, (Westinghouse Parts Business), New Stanton, PA (T, V)

## 77600 Servomechanisms

- ◆ Framatome Inc., (North American Headquarters), Lynchburg, VA

## 77700 Shells, Pressure Vessel

- Baker Industries, a Lincoln Electric Company, Macomb, MI
- Bilfinger Noell GmbH, (Dept. BEV), Wuerzburg, Germany
- Carolina Fabricators, West Columbia, SC
- Consolidated Power Supply, (Div. of Consolidated Pipe & Supply Co., Inc.), Birmingham, AL
- ◆ DuBose National Energy Services, Inc., Clinton, NC
- Ellis & Watts Global Industries, Inc., (a sub. of Marmor\*, a Berkshire Hathaway company), Batavia, OH
- Encorus Group, Springville, NY
- Energyen Corporation, (Sales Operation), Gunsan, Korea (The Republic of)
- Equipos Nucleares, S.A., S.M.E, Maliaño (Cantabria), Spain
- ◆ Framatome Inc., (North American Headquarters), Lynchburg, VA
- Joseph Oat Corp., Camden, NJ
- ◆ Major Tool & Machine, (A Precinmac Company), Indianapolis, IN
- NuSource LLC, Alexandria, VA
- ◆ Petersen Inc. (A Precinmac Company), Ogden, UT
- PMT Nuclear, Woodridge, IL
- ◆ Precision Custom Components, LLC., (DC Fabricators), York, PA
- ◆ Super Radiator Coils, Chaska, MN
- Teledyne Brown Engineering, Inc., Huntsville, AL
- ◆ Thermal Engineering International (TEi), Cerritos, CA
- Tioga Pipe, Philadelphia, PA
- Toshiba America Energy Systems Corp., West Allis, WI
- TW Metals - Nuclear Materials Solutions, Linden, MI
- Tyne USA Inc., Jacksonville, FL
- ◆ Wagstaff Applied Technologies, Spokane, WA
- ◆ Westinghouse Electric Company LLC, (Westinghouse Parts Business), New Stanton, PA

## 77750 Shielding Design, Radiation

- Advanced Nuclear LLC, Aston, PA
- Advanced Technologies and Laboratories (ATL) International, Inc., (wholly owned sub. of Planned Systems International, Inc.), Gaithersburg, MD
- Applied Analysis Corp., Reading, PA
- BHI Energy - now Westinghouse, See listing for Westinghouse Electric Co., Cranberry Township, PA
- Bilfinger Noell GmbH, (Dept. BEV), Wuerzburg, Germany
- Black & Veatch, Overland Park, KS
- BWX Technologies, Inc., Lynchburg, VA
- ◆ Curtiss-Wright Nuclear Division, Brea, CA

- Curtiss-Wright Nuclear Division, Scientech, Idaho Falls, ID
- Dufrane Nuclear Shielding Inc., (Dufrane Nuclear Inc.), Winsted, CT
- DW James Consulting, LLC, North Oaks, MN
- Ellis & Watts Global Industries, Inc., (a sub. of Marmor\*, a Berkshire Hathaway company), Batavia, OH
- Encorus Group, Springville, NY
- ◆ Framatome Inc., (North American Headquarters), Lynchburg, VA
- GE Hitachi Nuclear Energy, Wilmington, NC
- ◆ Holtec International, Camden, NJ
- Hopewell Designs, Inc., Alpharetta, GA
- Hot Cell Services Corp., (HCS Corp.), Kent, WA
- ISO-PACIFIC Remediation Technologies, Inc., Richland, WA
- Joseph Oat Corp., Camden, NJ
- Kinectrics Inc., Toronto, Ontario, Canada
- MarShield Radiation Shielding, (Div. of Marswell Metal Industries Ltd.), Burlington, Ontario, Canada
- Mirion Technologies (Canberra) Inc., Meriden, CT
- Mirion Technologies, Inc., (Sensing Systems Div.), Atlanta, GA
- NSSI/Recovery Services Inc., Houston, TX
- Nuclear Shielding Supplies & Service, Tucson, AZ
- NuclearConsultants.com, Ann Arbor, MI
- Pajarito Scientific Corp., Santa Fe, NM
- Paxton & Vierling Steel, Carter Lake, IA
- PMT Nuclear, Woodridge, IL
- Premier Technology, Inc., Blackfoot, ID
- Radiation Protection Systems, (by Alpha Safety), Groton, CT
- Radium Inc., Waynesboro, VA
- Red Wolf Associates, Cary, NC
- J. L. Shepherd & Assoc., San Fernando, CA
- Southwest Research Institute, San Antonio, TX
- ◆ Strategic Packaging Systems, (I.C.E. Packaging Company, LLC), Madisonville, TN
- Tetra Tech Inc., Richland, WA
- TRAD - RayXpert, Labège cedex, France
- Tranco Products Inc., Streator, IL
- TransWare Enterprises Inc., St. Louis, MO
- ◆ Wagstaff Applied Technologies, Spokane, WA
- Westinghouse Electric Co. LLC, Cranberry Township, PA
- ◆ WMG, Inc., Peekskill, NY

## 77800 Shielding Materials, Radiation

- AS Acrylic Sheeting Products, Beta-Shielding
- A Aggregates, High-Density Concrete
- B Blankets
- CB Blocks, Concrete, Lead-Core
- BH Blocks, Concrete, High-Density
- BM Blocks, Modular
- BC Boron Carbide Grain & Shapes
- BR Bricks, Composite
- BL Bricks, Lead
- CM Castable Shielding Materials
- CC Castings, Composite
- CL Castings, Lead
- CA Castles, Lead
- CS Collars, Streaming
- CW Container Wraps
- CR Criticality Control
- CU Curtain Shields
- E Encapsulation
- F Fiber
- F Foam
- FS Frisker Shields
- GN Gamma/Neutron Composite
- GR Glass, Radiation Resistant
- GS Glass, Scintillating, Radiation Resistant
- G Glass, X-ray
- IV In-Vessel Shields
- LF Lead Free
- LP Lead Plastic
- L Lenses, Radiation Resistant
- LL Low-Level Shields, Lead/Steel
- PW Pipe Wraps/Sleeves
- PC Plugs, Closures
- P Polyethylene
- PB Polyethylene, Borated
- RF Refueling Shields
- TN Thermal Neutron Materials
- TA Tungsten Alloys
- WP Wall Panels
- WS Water Shields, Modular (Gamma/Neutron)

- 3M Technical Ceramics, Inc., Quapaw, OK (CM, TN)
- Advantage Solutions, El Segundo, CA (B, CU, LF)
- AFO Research Inc., Vero Beach, FL (GR)
- F.N. Anderson & Assoc., Forest, VA (CR)
- ◆ AVANTech, LLC, Columbia, SC (LL, WP)
- Berthold Technologies USA LLC, Oak Ridge, TN (BL, CA)
- BHI CO., LTD., Haman-gun, Korea (The Republic of) (WP)
- Carolina Fabricators, West Columbia, SC (CM, CW, CU, E, LL, PW, PC, RF, WP)
- ◆ Curtiss-Wright Nuclear Division, Brea, CA (CR, CU, IV, LL, PC, RF, WS)
- Curtiss-Wright Nuclear Division, Scientech, Idaho Falls, ID (CR, CU, IV, LL, PC, RF, WS)
- Dufrane Nuclear Shielding Inc., (Dufrane Nuclear Inc.), Winsted, CT (A, B, CB, BH, BM, BR, BL, CM, CC, CL, CS, CW, CR, CU, FS, GN, G, IV, LL, PW, PC, P, PB, RF, TN, TA, WP, WS)
- ◆ EnergySolutions, Salt Lake City, UT (BM, CL, LL, WP)
- ◆ Framatome Inc., (North American Headquarters), Lynchburg, VA (B)
- Free Form Fibers, Saratoga Springs, NY (BC)
- ◆ Frham Safety Products, Inc., Rock Hill, SC (B, BL, PW)
- Frontier Technology Corp., Xenia, OH (GN, TN)
- General Plastics Mfg. Co., Tacoma, WA (F)
- Glidewell Specialties Foundry Co., Calera, AL (PC)
- ◆ Holtec International, Camden, NJ (CR, TN)
- Hopewell Designs, Inc., Alpharetta, GA (CM, CC, CL, CA, FS, GN, LL, WP)
- Hot Cell Services Corp., (HCS Corp.), Kent, WA (AS, GR, G, LP)
- JSM Protective, Inc., Port St. Lucie, FL (B)
- Lancs Industries, Albuquerque, NM (B, BR, BL, CU, FS, LF, PW, P, TA, WS)
- MarShield Radiation Shielding, (Div. of Marswell Metal Industries Ltd.), Burlington, Ontario, Canada (AS, A, B, CB, BH, BM, BR, BL, CM, CL, CA, CS, CW, CU, GN, G, LF, LP, LL, PW, P, PB, RF, TA, WP)
- MillenniTEK, LLC, Knoxville, TN (AS, BC, CM, CC, GN, TN)
- Mohawk Safety, Inc., Manchester, CT (BL)
- ◆ NAC International Inc., Peachtree Corners, GA (CC, GN, IV)
- NFT, (by Alpha Safety Group), Golden, CO (LL)
- NSSI/Recovery Services Inc., Houston, TX (BL, CL, LL, TN)
- Nuclear Shielding Supplies & Service, Tucson, AZ (A, CB, BM, BC, BR, CM, GN, LF)
- NuclearConsultants.com, Ann Arbor, MI (CR)
- ORTEC, Oak Ridge, TN (LL)
- ◆ PacTec, Inc., Clinton, LA (CW, CU, P)
- Pajarito Scientific Corp., Santa Fe, NM (GN, PW, PC)
- ◆ Preferred Engineering Corp., (Sub. of Preferred Utilities Mfg. Corp.), Danbury, CT (RF)
- Premier Technology, Inc., Blackfoot, ID (BL, CM, CL, G, LL)
- Radiation Protection Systems, (by Alpha Safety), Groton, CT (CU, FS, LF, LL, PC, RF, TA, WP, WS)
- Radium Inc., Waynesboro, VA (AS, B, BR, CW, CU, GN, G, RF, TN, TA, WP, WS)
- ◆ Reef Industries, Inc., (Griffolyn, Div. of Reef Industries, Inc.), Houston, TX (CW, P, RF)
- Rich Industries Inc., New Philadelphia, OH (AS, CW, CU, P)
- Robatel Technologies, LLC, Roanoke, VA (A, BM, BR, BL, CM, CL, GN, IV, LL, PW, TN, WP)
- Seafab Metals Co., (Div. of The Doe Run Co.), Casa Grande, AZ (BL, CL, LL)
- J. L. Shepherd & Assoc., San Fernando, CA
- ◆ Strategic Packaging Systems, (I.C.E. Packaging Company, LLC), Madisonville, TN (CW, E, P)
- Tranco Products Inc., Streator, IL (LF, TN, WP)
- Tri Nuclear Corp., Troy, NY (FS, WP)
- ◆ Wagstaff Applied Technologies, Spokane, WA (BL, CM, CL, CW, CR, CU, IV, PW)

## 77830 Shim Stock

- Carolina Fabricators, West Columbia, SC
- Consolidated Power Supply, (Div. of Consolidated Pipe & Supply Co., Inc.), Birmingham, AL
- ◆ Curtiss-Wright Nuclear Division, Brea, CA

♦ Denotes advertiser—see Index to Advertisers on pages 8–14

Curtiss-Wright Nuclear Division, AP Services, Middleburg Heights, OH  
 Curtiss-Wright Nuclear Division, Nova, Middleburg Heights, OH  
 ♦DuBose National Energy Services, Inc., Clinton, NC  
 Energy Steel, Rochester Hills, MI  
 Rexon Components, Inc., Beachwood, OH  
 Tioga Pipe, Philadelphia, PA  
 TW Metals - Nuclear Materials Solutions, Linden, MI

**77860 Shock Absorbers, Piping (Water Hammer)**

Carolina Fabricators, West Columbia, SC  
 ♦Element Nuclear (NTS Labs), (Nuclear Engineering & Test Services), Huntsville, AL  
 Energy Steel, Rochester Hills, MI  
 GE Hitachi Nuclear Energy, Wilmington, NC  
 Piping Technology & Products, Inc., Houston, TX

**77900 Shoring**

Carolina Fabricators, West Columbia, SC

**78100 Silencers, Steam Safety Valve**

♦Precision Custom Components, LLC., (DC Fabricators), York, PA

**78200 Silicone**

♦Curtiss-Wright Nuclear Division, Brea, CA  
 Curtiss-Wright Nuclear Division, AP Services, Middleburg Heights, OH  
 ♦Westinghouse Electric Company LLC, (Westinghouse Parts Business), New Stanton, PA

**78400 Simulators, Power Plant & Reactor**

ARES Security Corp., Vienna, VA  
 ♦Curtiss-Wright Nuclear Division, Brea, CA  
*See advertisement on page 43*  
 Curtiss-Wright Nuclear Division, Scientech, Idaho Falls, ID  
 E2S Co., Ltd., Hwaseong-si, Korea (The Republic of)  
 ♦Framatome Inc., (North American Headquarters), Lynchburg, VA  
 GE Hitachi Nuclear Energy, Wilmington, NC  
 GSE Engineering, Systems & Simulation, (GSE Systems), Columbia, MD  
 GSE Solutions, (GSE Systems), Columbia, MD  
 L3Harris MAPPS Inc., (Power Systems and Simulation), Montreal, Quebec, Canada  
 Mirion Technologies, Inc., (Sensing Systems Div.), Atlanta, GA  
 SIET, Piacenza, Italy  
 Toshiba America Energy Systems Corp., West Allis, WI  
 TRAD - RayXpert, Labège cedex, France  
 USERS Corp., Daejeon, Korea (The Republic of)  
 Westinghouse Electric Co. LLC, Cranberry Township, PA  
 ♦Westinghouse Electric Company LLC, (Westinghouse Parts Business), New Stanton, PA

**78700 Sleeves, Wall (Pipe)**

Carolina Fabricators, West Columbia, SC  
 ♦DuBose National Energy Services, Inc., Clinton, NC  
 Joseph Oat Corp., Camden, NJ  
 Lincoln Structural Solutions, Louisville, NE  
 Rich Industries Inc., New Philadelphia, OH

**79000 Snubbers**

FS Fuel Storage Rack  
 G Gauge  
 HV High-Vibration  
 H Hydraulic  
 LE Large Equipment  
 PS Pipe Support  
 Carolina Fabricators, West Columbia, SC (FS, G, HV, H, LE, PS)  
 ♦Element Nuclear (NTS Labs), (Nuclear Engineering & Test Services), Huntsville, AL (H, LE, PS)

Fronek - Anchor Darling Enterprises, Inc., (Sub. of Piping Technology & Products, Inc.), Laconia, NH (PS)  
 GE Hitachi Nuclear Energy, Wilmington, NC (G, LE, PS)  
 GSE Solutions, (GSE Systems), Columbia, MD (FS, G, HV, H, LE, PS)  
 Lincoln Structural Solutions, Louisville, NE (PS)  
 Nuclear Energy Components Ltd, Hope Valley, Derbyshire, United Kingdom (FS)  
 Piping Technology & Products, Inc., Houston, TX (PS)  
 ♦Westinghouse Electric Company LLC, (Westinghouse Parts Business), New Stanton, PA (FS, G, HV, H, LE, PS)

**79200 Sodium-Handling Equipment**

Joseph Oat Corp., Camden, NJ  
 Merrick & Company, Greenwood Village, CO

**79350 Solenoids**

Basic E, Inc., Charlotte, VT  
 Centronic Ltd., Surrey, United Kingdom  
 Curtiss-Wright Nuclear Division, QualTech NP, Cincinnati, OH  
 ♦Framatome Inc., (North American Headquarters), Lynchburg, VA  
 ♦Westinghouse Electric Company LLC, (Westinghouse Parts Business), New Stanton, PA

**79360 Solid Waste Reduction Equipment & Tools, Radioactive**

C Containment  
 CR Control Rod Crushers, Reducers  
 NW Neutron Window Reducers  
 P Packaging  
 SB Stellite Ball Punches  
 U Underwater Reduction Tools  
 VL Velocity Limiter Shears  
 Advanced Consulting Group, Inc., Chicago, IL (U)  
 ♦American DND Inc., Grand Island, NY (C, P)  
 ATS Industrial Automation, Inc. - Nuclear (UK), Blaby, Leicester, United Kingdom (C, P, U)  
 ATS Industrial Automation, Inc. Nuclear (Canada), Cambridge, Ontario, Canada (C, P, U)  
 Babcock Services, Inc., Kennewick, WA (C, CR, P, SB, U, VL)  
 Bilfinger Noell GmbH, (Dept. BEV), Wuerzburg, Germany (C, CR, P, U)  
 Croft Associates Ltd, Abingdon, Oxfordshire, United Kingdom (C)  
 ♦Curtiss-Wright Nuclear Division, Brea, CA (CR, U)  
 Curtiss-Wright Nuclear Division, Scientech, Idaho Falls, ID (CR, U)  
 ♦EnergySolutions, Salt Lake City, UT (CR, NW, SB, U, VL)  
 GNS Gesellschaft fur Nuklear-Service mbH, Essen, Germany (P, U)  
 James Fisher Technologies, Loveland, CO (C, U)  
 KUKA Systems UK Ltd, Halesowen, West Midlands, United Kingdom (P)  
 M2 Polymer Technologies, Inc., West Dundee, IL (P)  
 MarShield Radiation Shielding, (Div. of Marswell Metal Industries Ltd.), Burlington, Ontario, Canada (C)  
 Orano USA, Bethesda, MD (P, U)  
 ♦PacTec, Inc., Clinton, LA (C, P)  
 PAR Systems, LLC, Saint Paul, MN (U)  
 Premier Technology, Inc., Blackfoot, ID (C, P)  
 Radiation Pros, LLC, (dba Rad Pros), Englewood, CO (P)  
 Rich Industries Inc., New Philadelphia, OH (C)  
 Robatel Technologies, LLC, Roanoke, VA (CR, P)  
 Scientific Sales, Inc., Oak Ridge, TN (C, P, U)  
 Siempelkamp NIS, Alzenau, Germany (P)  
 ♦Strategic Packaging Systems, (I.C.E. Packaging Company, LLC), Madisonville, TN (P)  
 Toshiba America Energy Systems Corp., West Allis, WI (CR, P, U, VL)  
 Veolia Nuclear Solutions - Federal Services, Piketon, OH (C, P)  
 ♦Wagstaff Applied Technologies, Spokane, WA (C, CR, P)

Westinghouse Electric Co. LLC, Cranberry Township, PA (C, P, U)  
 ♦WMG, Inc., Peekskill, NY (P)

**79370 Sorbents**

ES Environmental Spill  
 LR Liquid Radwaste  
 ♦Alphasource, Inc., Philadelphia, PA (ES)  
 ♦AVANTech, LLC, Columbia, SC (LR)  
 Babcock Services, Inc., Kennewick, WA (LR)  
 ♦Fram Safety Products, Inc., Rock Hill, SC (ES, LR)  
 JRM Chemical Inc., Cleveland, OH (ES, LR)  
 JSM Protective, Inc., Port St. Lucie, FL (ES)  
 Kinectrics Inc., Toronto, Ontario, Canada (ES)  
 M2 Polymer Technologies, Inc., West Dundee, IL (ES, LR)  
 METOIL, Praha, Czech Republic (The) (LR)  
 Mohawk Safety, Inc., Manchester, CT (ES)  
 NAC Philotechnics, Ltd., Oak Ridge, TN (ES, LR)  
 ♦NUCON International, Inc., Columbus, OH (LR)  
 River Technologies, LLC, Forest, VA (LR)  
 Scientific Sales, Inc., Oak Ridge, TN (ES, LR)

**79740 Spare & Replacement Parts (Secondary Sources)**

Baker Industries, a Lincoln Electric Company, Macomb, MI  
 Carolina Fabricators, West Columbia, SC  
 ♦Curtiss-Wright Nuclear Division, Brea, CA  
 Curtiss-Wright Nuclear Division, Nova, Middleburg Heights, OH  
 Curtiss-Wright Nuclear Division, QualTech NP, Cincinnati, OH  
 Curtiss-Wright Nuclear Division, Scientech, Idaho Falls, ID  
 ♦DuBose National Energy Services, Inc., Clinton, NC  
 Electrical Builders Inc. (EBI), St. Cloud, MN  
 Ellis & Watts Global Industries, Inc., (a sub. of Marmon), a Berkshire Hathaway company), Batavia, OH  
 ♦Framatome Inc., (North American Headquarters), Lynchburg, VA  
 GE Hitachi Nuclear Energy, Wilmington, NC  
 Kinectrics Inc., Toronto, Ontario, Canada  
 ♦Major Tool & Machine, (A Precinmac Company), Indianapolis, IN  
 ♦Mirion Technologies (IST) Corp., (Sensing Systems Div.), Horseheads, NY  
 Mirion Technologies, Inc., (Sensing Systems Div.), Atlanta, GA  
 NuSource LLC, Alexandria, VA  
 ♦Paragon Energy Solutions, (Paragon), Fort Worth, TX  
 PMT Nuclear, Woodridge, IL  
 Schulz Electric, Timken Power Systems, East Haven, CT  
 SKODA JS a.s., Plzen, Bolevec, Czech Republic (The)  
 ♦SSM Industries, Inc., (Nuclear Div.), Pittsburgh, PA  
 Tioga Pipe, Philadelphia, PA  
 Trust Manufacturing, LLC, Euclid, OH  
 UCC Industries International Inc., Pickering, Ontario, Canada  
 Westinghouse Electric Co. LLC, Cranberry Township, PA  
 ♦Westinghouse Electric Company LLC, (Westinghouse Parts Business), New Stanton, PA

**79850 Spectroscopy Systems**

ANTECH Corp., Arvada, CO  
 Centronic Ltd., Surrey, United Kingdom  
 ENVINET GmbH, Munich/Haar, Germany  
 Mirion Technologies (Canberra) Inc., Meriden, CT  
 ORTEC, Oak Ridge, TN  
 Pajarito Scientific Corp., Santa Fe, NM  
 Pylon Electronics Inc., (Instrument Manufacturing Div.), Ottawa, Ontario, Canada  
 Scientific Sales, Inc., Oak Ridge, TN

**80200 Splitters, Electronic Signal**

Basic E, Inc., Charlotte, VT  
 ♦Westinghouse Electric Company LLC, (Westinghouse Parts Business), New Stanton, PA

**80400 Springs**

Carolina Fabricators, West Columbia, SC  
Cross Manufacturing Co. (1938) Ltd., Bath,  
United Kingdom  
PMT Nuclear, Woodridge, IL  
◆ Westinghouse Electric Company LLC,  
(Westinghouse Parts Business), New Stanton,  
PA

**80520 Stacks, Off-Gas**

Premier Technology, Inc., Blackfoot, ID

**80565 Standards**

T Testing  
Kinectrics Inc., Toronto, Ontario, Canada (T)  
SIET, Piacenza, Italy (T)

**80600 Startup Services**

BHI Energy - now Westinghouse, See listing  
for Westinghouse Electric Co., Cranberry  
Township, PA  
Black & Veatch, Overland Park, KS  
BWx Technologies, Inc., Lynchburg, VA  
◆ Curtiss-Wright Nuclear Division, Brea, CA  
Curtiss-Wright Nuclear Division, Scientech,  
Idaho Falls, ID  
Ellis & Watts Global Industries, Inc., (a sub. of  
"Marmon", a Berkshire Hathaway company),  
Batavia, OH  
◆ EnergySolutions, Salt Lake City, UT  
◆ Framatome Inc., (North American  
Headquarters), Lynchburg, VA  
GE Hitachi Nuclear Energy, Wilmington, NC  
Merrick & Company, Greenwood Village, CO  
Mirion Technologies, Inc., (Sensing Systems  
Div.), Atlanta, GA  
Toshiba America Energy Systems Corp., West  
Allis, WI  
Westinghouse Electric Co. LLC, Cranberry  
Township, PA

**80730 Steam Generator Maintenance & Repair**

C Cleaning  
CS Computer Software  
EC Eddy Current Testing  
GW Girth Weld Maintenance  
IS In-Service Inspection  
MC Manway Cover Handling Equipment  
NI Nickel Electroplating  
PN Penetrations, Nozzles, & Handholds  
P Plugging  
R Replacement  
S Slewing  
TX Tube Expansion  
TE Tube Extraction  
TH Tube Heat Treatment  
SP Tube Shot Peening  
◆ Bechtel, (Bechtel Power), (Bechtel Nuclear,  
Security & Environmental), (Bechtel National),  
Reston, VA (R)  
BHI Energy - now Westinghouse, See listing  
for Westinghouse Electric Co., Cranberry  
Township, PA (R)  
Bureau Veritas Inspection and Insurance Co.,  
(previously OneCIS Inspection and Insurance  
Co.), Lynn, MA (IS)  
BWx Technologies, Inc., Lynchburg, VA (C, CS,  
EC, IS, PN, P, R, S, TX, TE)  
◆ Curtiss-Wright EST Group, Hatfield, PA (P, S)  
◆ Curtiss-Wright Nuclear Division, Brea, CA (MC)  
Curtiss-Wright Nuclear Division, Scientech,  
Idaho Falls, ID (MC)  
◆ Dominion Engineering, Inc., Reston, VA (C)  
E.H. Wachs, (A Div. of ITW), Lincolnshire, IL (R)  
E.S. Fox Limited, Niagara Falls, Ontario, Canada  
(C, R)  
ETAP - Operation Technology, Inc., Irvine, CA  
(CS)  
◆ Framatome Inc., (North American  
Headquarters), Lynchburg, VA (C, CS, EC, GW,  
IS, MC, NI, PN, P, R, S, TX, TE, TH, SP)  
Fuel Tank Maintenance Co., LLC, Cookeville, TN  
(C)  
Heat Exchanger Products Corp. (HEPCO),  
Hingham, MA (C, P)  
Hennigan Engineering LLC, Hingham, MA (C)

Kinectrics Inc., Toronto, Ontario, Canada (C, EC,  
IS)  
Mitsubishi Nuclear Energy Systems, Inc., (A Sub.  
of Mitsubishi Heavy Industries, Ltd.), Charlotte,  
NC (C, CS, EC, GW, IS, MC, NI, PN, P, R, S, TX,  
TE, TH, SP)  
Power Services Group, (Power Plant Services,  
Orbital Energy Services, Airco, Turbine  
Generator Maintenance), Cape Coral, FL (C)  
◆ Preferred Engineering Corp., (Sub. of Preferred  
Utilities Mfg. Corp.), Danbury, CT (MC)  
PROTEM USA LLC, Evergreen, CO (R, TE)  
Radium Inc., Waynesboro, VA (C, MC)  
Rich Industries Inc., New Philadelphia, OH (S)  
Sarens Nuclear & Industrial Services LLC,  
(Sarens), Houston, TX (R)  
Sonic Systems International, LLC, Houston, TX  
(EC, IS)  
Toshiba America Energy Systems Corp., West  
Allis, WI (C, EC, R)  
TW Metals - Nuclear Materials Solutions, Linden,  
MI (P)  
Westinghouse Electric Co. LLC, Cranberry  
Township, PA (C, CS, EC, IS, MC, PN, P, R, S, TX,  
TE, TH, SP)

**80800 Steam Generators, Power Plant**

AECON-WACHS, (U.S. Div. of Aecon Nuclear),  
Jackson, SC  
BHI Energy - now Westinghouse, See listing  
for Westinghouse Electric Co., Cranberry  
Township, PA  
Black & Veatch, Overland Park, KS  
BWx Technologies, Inc., Lynchburg, VA  
Equipos Nucleares, S.A., S.M.E, Maliaño  
(Cantabria), Spain  
ETAP - Operation Technology, Inc., Irvine, CA  
◆ Framatome Inc., (North American  
Headquarters), Lynchburg, VA

*See advertisement on pages 6-7*

Heatric Division of Meggitt (UK) Ltd., Poole,  
Dorset, United Kingdom  
Imperia Engineering Partners LLC, Milford, MA  
Mitsubishi Nuclear Energy Systems, Inc., (A Sub.  
of Mitsubishi Heavy Industries, Ltd.), Charlotte,  
NC  
Power Services Group, (Power Plant Services,  
Orbital Energy Services, Airco, Turbine  
Generator Maintenance), Cape Coral, FL  
◆ Precision Custom Components, LLC., (DC  
Fabricators), York, PA  
Toshiba America Energy Systems Corp., West  
Allis, WI

**80900 Steam Generators, Stand-by, Auxiliary**

AECON-WACHS, (U.S. Div. of Aecon Nuclear),  
Jackson, SC  
Black & Veatch, Overland Park, KS  
ETAP - Operation Technology, Inc., Irvine, CA  
◆ Framatome Inc., (North American  
Headquarters), Lynchburg, VA  
Heatric Division of Meggitt (UK) Ltd., Poole,  
Dorset, United Kingdom

**81000 Steam Separators, Power Plant**

AECON-WACHS, (U.S. Div. of Aecon Nuclear),  
Jackson, SC  
◆ Framatome Inc., (North American  
Headquarters), Lynchburg, VA  
Toshiba America Energy Systems Corp., West  
Allis, WI

**81680 Storage Services**

E Equipment  
FF Fresh Fuel  
SF Spent Fuel  
UE Uranium, Enriched  
UN Uranium, Natural  
◆ Barnhart Nuclear Services, Fairhope, AL (E)  
Croft Associates Ltd, Abingdon, Oxfordshire,  
United Kingdom (SF)  
◆ Curtiss-Wright Nuclear Division, Brea, CA (FF,  
SF)  
Curtiss-Wright Nuclear Division, NETCO,  
Danbury, CT (FF, SF)  
Curtiss-Wright Nuclear Division, Scientech,  
Idaho Falls, ID (SF)

◆ EnergySolutions, Salt Lake City, UT (E)  
◆ Framatome Inc., (North American  
Headquarters), Lynchburg, VA (E, FF, UE)  
FuseRing Inc., London, Ontario, Canada (SF)  
GE Hitachi Nuclear Energy, Wilmington, NC (E,  
SF)  
◆ Holtec International, Camden, NJ (E, SF)  
Konecranes Nuclear Equipment & Services LLC,  
(Formerly Morris Material Handling / P&H),  
New Berlin, WI (E)  
Mitsubishi Nuclear Energy Systems, Inc., (A Sub.  
of Mitsubishi Heavy Industries, Ltd.), Charlotte,  
NC (E, FF, SF, UE, UN)  
NuclearConsultants.com, Ann Arbor, MI (FF, SF)  
Orano TN, Columbia, MD (SF)  
Orano USA, Bethesda, MD (FF, SF, UE, UN)  
◆ Petersen Inc. (A Precinmac Company), Ogden,  
UT (E)  
PTP Spent Fuel Services, LLC, Grand Island, NY  
(E, SF)  
Sarens Nuclear & Industrial Services LLC,  
(Sarens), Houston, TX (SF)  
Schulz Electric, Timken Power Systems, East  
Haven, CT (E)  
Standish Technologies International, Export, PA  
(SF)  
TransWare Enterprises Inc., St. Louis, MO (SF)  
UxC, LLC, Roswell, GA (SF)  
Westinghouse Electric Co. LLC, Cranberry  
Township, PA (E, FF, SF)

**81710 Storage Systems, Spent-Fuel**

D Dry  
W Wet  
Baker Industries, a Lincoln Electric Company,  
Macomb, MI (D, W)  
Bilfinger Noell GmbH, (Dept. BEV), Wuerzburg,  
Germany (D, W)  
BWx Technologies, Inc., Lynchburg, VA (D, W)  
Carolina Fabricators, West Columbia, SC (D, W)  
Croft Associates Ltd, Abingdon, Oxfordshire,  
United Kingdom (D, W)  
◆ Curtiss-Wright Nuclear Division, Brea, CA (D, W)  
Curtiss-Wright Nuclear Division, Scientech,  
Idaho Falls, ID (D, W)  
Equipos Nucleares, S.A., S.M.E, Maliaño  
(Cantabria), Spain (D, W)  
FuseRing Inc., London, Ontario, Canada (D)  
GNS Gesellschaft fur Nuklear-Service mbH,  
Essen, Germany (D)  
◆ Holtec International, Camden, NJ (D, W)  
Joseph Oat Corp., Camden, NJ (D, W)  
Konecranes Nuclear Equipment & Services LLC,  
(Formerly Morris Material Handling / P&H),  
New Berlin, WI (D, W)  
◆ Major Tool & Machine, (A Precinmac Company),  
Indianapolis, IN (D, W)  
Mega-Tech Services, LLC, Cooksburg, PA (D)  
◆ NAC International Inc., Peachtree Corners, GA  
(D)  
Orano TN, Columbia, MD (D)  
Orano USA, Bethesda, MD (D)  
PAR Systems, LLC, Saint Paul, MN (W)  
◆ Petersen Inc. (A Precinmac Company), Ogden,  
UT (D)  
◆ Precision Custom Components, LLC., (DC  
Fabricators), York, PA (D, W)  
Premier Technology, Inc., Blackfoot, ID (D)  
PTP Spent Fuel Services, LLC, Grand Island, NY  
(D, W)  
◆ Reef Industries, Inc., (Griffolyn, Div. of Reef  
Industries, Inc.), Houston, TX (D)  
Robatel Technologies, LLC, Roanoke, VA (D, W)  
SKODA JS a.s., Plzen, Bolevec, Czech Republic  
(The) (D, W)  
Tetra Tech Inc., Richland, WA (D)  
UxC, LLC, Roswell, GA (D, W)  
◆ Wagstaff Applied Technologies, Spokane, WA (D,  
W)  
Westinghouse Electric Co. LLC, Cranberry  
Township, PA (D, W)

**81790 Strainers**

E ECCS  
LO Lubricating Oil, Basket, Manual  
SH Solids, Hair, Debris  
SP Suppression Pool  
WA Water, Automatic  
WB Water, Basket, Manual

◆ Denotes advertiser—see Index to Advertisers on pages 8–14

- ◆ Aerofin, Lynchburg, VA (WA)  
BHI CO., LTD., Haman-gun, Korea (The Republic of) (SH)
- ◆ DuBose National Energy Services, Inc., Clinton, NC (WB)
- ◆ Framatome Inc., (North American Headquarters), Lynchburg, VA (E, SH, WA)  
GE Hitachi Nuclear Energy, Wilmington, NC (E, SP)  
Heatric Division of Meggitt (UK) Ltd., Poole, Dorset, United Kingdom (WB)  
Joseph Oat Corp., Camden, NJ (E, LO, SH, SP, WB)  
Newark Wire Cloth Co., Cedar Grove, NJ (LO, SP, WB)  
NuSource LLC, Alexandria, VA (LO, SH, SP, WA, WB)  
Scientific Sales, Inc., Oak Ridge, TN (E, LO, SH, SP, WA, WB)
- ◆ Super Radiator Coils, Chaska, MN (WA)  
Transco Products Inc., Streator, IL (E)
- ◆ Westinghouse Electric Company LLC, (Westinghouse Parts Business), New Stanton, PA (E, LO, SH, SP, WA, WB)

### 82200 Stress-Relieving Equipment

- ◆ Framatome Inc., (North American Headquarters), Lynchburg, VA  
Lambda Technologies, (Surface Enhancement Technologies, LLC and Lambda Research, Inc.), Cincinnati, OH
- ◆ Petersen Inc. (A Precinmac Company), Ogden, UT

### 82250 Structural Supports, Component

- Baker Industries, a Lincoln Electric Company, Macomb, MI
- Carolina Fabricators, West Columbia, SC
- Consolidated Power Supply, (Div. of Consolidated Pipe & Supply Co., Inc.), Birmingham, AL
- ◆ DuBose National Energy Services, Inc., Clinton, NC

- Electrical Builders Inc. (EBI), St. Cloud, MN
- ◆ Framatome Inc., (North American Headquarters), Lynchburg, VA  
Joseph Oat Corp., Camden, NJ  
Lincoln Structural Solutions, Louisville, NE
- ◆ Major Tool & Machine, (A Precinmac Company), Indianapolis, IN
- Mitsubishi Nuclear Energy Systems, Inc., (A Sub. of Mitsubishi Heavy Industries, Ltd.), Charlotte, NC
- NuSource LLC, Alexandria, VA
- Paxton & Vierling Steel, Carter Lake, IA
- PMT Nuclear, Woodridge, IL
- ◆ SSM Industries, Inc., (Nuclear Div.), Pittsburgh, PA
- Tioga Pipe, Philadelphia, PA
- Toshiba America Energy Systems Corp., West Allis, WI
- Trust Manufacturing, LLC, Euclid, OH
- ◆ Westinghouse Electric Company LLC, (Westinghouse Parts Business), New Stanton, PA

### 82310 Structures, Fabric Tensioned

- Carolina Fabricators, West Columbia, SC
- Consolidated Power Supply, (Div. of Consolidated Pipe & Supply Co., Inc.), Birmingham, AL
- ◆ DuBose National Energy Services, Inc., Clinton, NC
- Lincoln Structural Solutions, Louisville, NE
- Radiation Protection Systems, (by Alpha Safety), Groton, CT
- Rich Industries Inc., New Philadelphia, OH

### 82800 Superheaters, Power Plant

- Joseph Oat Corp., Camden, NJ
- Mitsubishi Nuclear Energy Systems, Inc., (A Sub. of Mitsubishi Heavy Industries, Ltd.), Charlotte, NC
- ◆ Thermal Engineering International (TEi), Cerritos, CA

### 82950 Switches

- D Differential
- FT Float
- F Flow
- HT High-Temperature
- HV High-Voltage
- KO Key-Operated
- K Knife
- L Limit
- LL Liquid Level
- MG Magnetic
- MR Mercury
- MC Momentary Contact
- PW Power
- P Pressure
- PD Pressure, Differential
- PG Programmable
- PL Proximity Limit
- PB Push Button
- RE Reed
- RK Rocker
- RO Rotary
- SA Safety
- S Slide
- SL Solenoid
- SS Solid-State
- T Temperature
- TG Toggle
- V Vacuum

Automation Products, Inc., (Dynatrol Div.), Houston, TX (LL)

Basic E, Inc., Charlotte, VT (D, FT, F, HT, HV, KO, K, L, LL, MG, MR, MC, PW, P, PD, PG, PL, PB, RE, RK, RO, SA, S, SL, SS, T, TG, V)

- ◆ Curtiss-Wright Nuclear Division, Brea, CA (D, FT, F, HT, KO, L, LL, MG, MC, PW, P, PD, PG, PL, PB, RO, SA, SL, SS, T, TG, V)

Curtiss-Wright Nuclear Division, QualTech NP, Cincinnati, OH (D, FT, F, HT, KO, L, LL, MG, MC, PW, P, PD, PG, PL, PB, RO, SA, SL, SS, T, TG, V)

- ◆ Element Nuclear (NTS Labs), (Nuclear Engineering & Test Services), Huntsville, AL (FT, L, PW, P, PD, PB, SA, SL, SS, T)



**HOLTEC**  
INTERNATIONAL

## Holtec International's Vertical Integration Includes:

**A Global Turnkey Supplier Serving the Energy Industry with Advanced Power Generation Technologies, Since 1986**

*Core Competencies Include:*

- Dry and Wet Spent Nuclear Fuel Storage Equipment
- Heat Transfer Equipment
- Engineering and Consulting Services
- Construction / Site Services
- Advanced Nuclear Power Generation (SMR-300)



- Design
- Engineering
- Licensing
- Fabrication
- Construction
- Site Installation
- Decommissioning
- Consolidated Interim Storage

**856-797-0900 | [www.holtec.com](http://www.holtec.com)**

- FCI-Fluid Components International, San Marcos, CA (F, HT, LL, T)
- ♦ Framatome Inc., (North American Headquarters), Lynchburg, VA (F, HV, P, PD, T) GLSEQ, LLC, Huntsville, AL (P)
- KROHNE, (KROHNE Nuclear), Romans-sur-Isère, France (F, LL)
- NuSource LLC, Alexandria, VA (HT, L, PW, P, PD)
- ♦ Paragon Energy Solutions, (Paragon), Fort Worth, TX (D, FT, F, HT, HV, KO, K, L, LL, MG, MR, MC, PW, P, PD, PG, PL, PB, RE, RO, SA, SL, SS, T, TG, V)
- PMT Nuclear, Woodridge, IL (D, FT, F, HT, L, LL, MG, MC, P, PD, PL, PB, RO, SL, T, TG, V)
- SOR Inc., Lenexa, KS (P, PD, T, V)
- Struthers-Dunn, LLC, Timmonsville, SC (HT, HV, MG, MR, PW, PG, RE, SA)
- Syscom Instruments S.A., Sainte-Croix, Switzerland (SA)
- Tyne USA Inc., Jacksonville, FL (D, FT, F, HT, HV, PW, P, PD, PG, T, V)
- Westinghouse Electric Co. LLC, Cranberry Township, PA (D, FT, F, HT, HV, KO, K, L, LL, MG, MR, MC, PW, P, PD, PB, RK, RO, SA, S, SL, SS, T, TG)
- ♦ Westinghouse Electric Company LLC, (Westinghouse Parts Business), New Stanton, PA (D, FT, F, HT, HV, KO, K, L, LL, MG, MR, MC, PW, P, PD, PG, PL, PB, RE, RK, RO, SA, S, SL, SS, T, TG, V)

### 83110 Tags & Labels (Warning, Inventory, etc.)

- ♦ Alphasource, Inc., Philadelphia, PA
- Coastal Network, Inc, Charlottesville, VA
- ♦ Frham Safety Products, Inc., Rock Hill, SC
- JSM Protective, Inc., Port St. Lucie, FL
- Mohawk Safety, Inc., Manchester, CT
- Scientific Sales, Inc., Oak Ridge, TN
- Tech Products, Inc., Staten Island, NY

### 83120 Tags, Valve

- Energy Steel, Rochester Hills, MI
- JSM Protective, Inc., Port St. Lucie, FL
- Scientific Sales, Inc., Oak Ridge, TN
- Tech Products, Inc., Staten Island, NY

### 83150 Tanks, Storage

- AL Aluminum
- GF Glass Fiber
- P Plastic
- R Rubber, Collapsible
- S Steel
- SS Steel, Stainless
- ♦ Aerofin, Lynchburg, VA (S, SS)
- ♦ AVANTech, LLC, Columbia, SC (S, SS)
- Baker Industries, a Lincoln Electric Company, Macomb, MI (AL, GF, P, S, SS)
- Billfinger Noell GmbH, (Dept. BEV), Wuerzburg, Germany (S, SS)
- BWX Technologies, Inc., Lynchburg, VA (S, SS)
- Carolina Fabricators, West Columbia, SC (AL, S, SS)
- Container Technologies Industries, LLC, Helenwood, TN (S)
- Corrosion Control Services, Inc., Davenport, IA (RC)
- ♦ Curtiss-Wright Nuclear Division, Brea, CA (SS)
- Curtiss-Wright Nuclear Division, QualTech NP, Cincinnati, OH (SS)
- ♦ DuBose National Energy Services, Inc., Clinton, NC (S, SS)
- E.S. Fox Limited, Niagara Falls, Ontario, Canada (AL, S, SS)
- Energy Steel, Rochester Hills, MI (AL)
- Equipos Nucleares, S.A., S.M.E, Maliaño (Cantabria), Spain (S, SS)
- ♦ Framatome Inc., (North American Headquarters), Lynchburg, VA (S, SS)
- Fuel Tank Maintenance Co., LLC, Cookeville, TN (S, SS)
- H. Butting GmbH & Co. KG, Wittingen-Knesebeck, Germany (SS)
- Heatric Division of Meggitt (UK) Ltd., Poole, Dorset, United Kingdom (SS)
- Joseph Oat Corp., Camden, NJ (S, SS)
- JSM Protective, Inc., Port St. Lucie, FL (AL, P, RC, S, SS)

- ♦ Major Tool & Machine, (A Precinmac Company), Indianapolis, IN (AL, S, SS)
- Mitsubishi Nuclear Energy Systems, Inc., (A Sub. of Mitsubishi Heavy Industries, Ltd.), Charlotte, NC (AL, P, RC, S, SS)
- NuSource LLC, Alexandria, VA (S, SS)
- ♦ Paragon Energy Solutions, (Paragon), Fort Worth, TX (S, SS)
- ♦ Petersen Inc. (A Precinmac Company), Ogden, UT (AL, S, SS)
- PMT Nuclear, Woodridge, IL (AL, S, SS)
- ♦ Precision Custom Components, LLC., (DC Fabricators), York, PA (S, SS)
- Premier Technology, Inc., Blackfoot, ID (AL, S, SS)
- Robatel Technologies, LLC, Roanoke, VA (SS)
- ♦ SSM Industries, Inc., (Nuclear Div.), Pittsburgh, PA (AL, S, SS)
- Tri Nuclear Corp., Troy, NY (SS)
- TW Metals - Nuclear Materials Solutions, Linden, MI (S, SS)
- ♦ Wagstaff Applied Technologies, Spokane, WA (AL, S, SS)
- ♦ Westinghouse Electric Company LLC, (Westinghouse Parts Business), New Stanton, PA (AL, GF, P, RC, S, SS)

### 83210 Tape

- C Cloth, Nuclear
- E Electrical Splicing Tape
- F Foam
- MS Moisture-Sensitive
- RS Reinforced Strapping, Nuclear
- WL Warning, Luminescent
- ♦ Alphasource, Inc., Philadelphia, PA (C, E, F, WL)
- Aquasol Corp., North Tonawanda, NY (MS)
- Basic E, Inc., Charlotte, VT (E)
- Coastal Network, Inc, Charlottesville, VA (C, WL)
- ♦ Curtiss-Wright Nuclear Division, Brea, CA (E)
- Curtiss-Wright Nuclear Division, QualTech NP, Cincinnati, OH (E)
- ♦ Frham Safety Products, Inc., Rock Hill, SC (C, E, MS, RS, WL)
- General Plastics Mfg. Co., Tacoma, WA (F)
- JSM Protective, Inc., Port St. Lucie, FL (C, E, F, MS, RS, WL)
- Lancs Industries, Albuquerque, NM (C, MS, RS, WL)
- Mohawk Safety, Inc., Manchester, CT (C, MS, RS)
- ♦ Paragon Energy Solutions, (Paragon), Fort Worth, TX (E)
- ♦ Reef Industries, Inc., (Griffolyn, Div. of Reef Industries, Inc.), Houston, TX (MS, RS, WL)
- Rich Industries Inc., New Philadelphia, OH (C, RS)
- Scientific Sales, Inc., Oak Ridge, TN (C, E, F, MS, RS, WL)
- ♦ Westinghouse Electric Company LLC, (Westinghouse Parts Business), New Stanton, PA (C, E, F, MS, RS, WL)

### 83600 Television Systems (CCTV)

- C Conventional
- HT High-Temperature
- M Miniature (Remote Viewing)
- PI Pipe Inspection
- U Underwater, Color, High-Radiation
- W Welding Arc Viewing (Color)
- ♦ AVANTech, LLC, Columbia, SC (C)
- BHI Energy - now Westinghouse, See listing for Westinghouse Electric Co., Cranberry Township, PA (PI)
- Centronic Ltd., Surrey, United Kingdom (HT, M, U)
- ♦ Dominion Engineering, Inc., Reston, VA (U)
- ♦ Framatome Inc., (North American Headquarters), Lynchburg, VA (C)
- Lenox Instrument Co., Inc., Trevese, PA (HT, M, PI, U, W)
- Magnatech LLC, East Granby, CT (W)
- ♦ Mirion Technologies (IST) Corp., (Sensing Systems Div.), Horseheads, NY (C, HT, M, PI, U, W)
- Mirion Technologies, Inc., (Sensing Systems Div.), Atlanta, GA (C, HT, M, PI, U)
- Radium Inc., Waynesboro, VA (C, HT, M, PI, U, W)
- ♦ Remote Ocean Systems (ROS), San Diego, CA (C, M, U)

- Sidus Solutions LLC, San Diego, CA (C, HT, M, PI, U)
- Siempelkamp NIS, Alzenau, Germany (M, U)
- ♦ Thermo Scientific - CIDTEC Cameras & Imagers, (Part of Thermo Fisher Scientific), Liverpool, NY (C, M, PI, U, W)

### 84000 Tensioners, Stud, Hydraulic

- ATS Industrial Automation, Inc. - Nuclear (UK), Blaby, Leicester, United Kingdom
- ATS Industrial Automation, Inc. Nuclear (Canada), Cambridge, Ontario, Canada
- ♦ Curtiss-Wright Nuclear Division, Brea, CA
- Curtiss-Wright Nuclear Division, Nova, Middleburg Heights, OH
- Curtiss-Wright Nuclear Division, Scientech, Idaho Falls, ID
- ♦ Framatome Inc., (North American Headquarters), Lynchburg, VA
- GE Hitachi Nuclear Energy, Wilmington, NC
- Integra Services Technologies Inc., Sarnia, Ontario, Canada
- SKODA JS a.s., Plzen, Bolevec, Czech Republic (The)
- ♦ Westinghouse Electric Company LLC, (Westinghouse Parts Business), New Stanton, PA

### 84100 Terminal Blocks

- Basic E, Inc., Charlotte, VT
- Curtiss-Wright Nuclear Division, QualTech NP, Cincinnati, OH
- ♦ Element Nuclear (NTS Labs), (Nuclear Engineering & Test Services), Huntsville, AL
- PMT Nuclear, Woodridge, IL
- ♦ Westinghouse Electric Company LLC, (Westinghouse Parts Business), New Stanton, PA

### 84150 Test Equipment & Supplies

- A Automated
- CS Capacitance Strain Gauging
- CP Coating Porosity Detection
- CT Coating Thickness Gauging
- C Concrete Inspection
- EC Eddy Current
- EM Electric Motors
- ES Electrical Systems & Components
- E Environmental
- FD Ferrite Detection (SS Welds)
- FO Fiber Optic
- HE HEPA Filter
- II Infrared Imaging
- IC Instrumentation & Control
- LR Leak-Rate, Local
- M Manual
- MT Materials
- ND Nondestructive
- PH pH Measurement
- P Portable
- PA Power Apparatus
- RT Resistance Temperature Detectors
- S Stationary
- SC Structures/Components
- U Ultrasonic
- UC Ultrasonic Couplant
- VL Vacuum Leak Testers, Tube
- V Valve
- VM Valve, Motor-Operated, Diagnostic
- VS Valve, Solenoid Operated, Diagnostic
- V Vibration
- Baker Industries, a Lincoln Electric Company, Macomb, MI (A, M, P, SC)
- BWX Technologies, Inc., Lynchburg, VA (ND)
- CableLAN Nuclear, Fort Myers, FL (FO)
- Camfil USA, Inc., Washington, NC (HE)
- CBS Nuclear Services, Inc., Matthews, NC (ES)
- CM Technologies Corp., Coraopolis, PA (A, EM, ES, IC, ND)
- ♦ Curtiss-Wright Nuclear Division, Brea, CA (A, CT, EC, ND, U)
- Curtiss-Wright Nuclear Division, Anatec, Brea, CA (A, EC, ND, U)
- Curtiss-Wright Nuclear Division, LMT, Hutchinson, MN (CT, ND, U)
- DETEK, Temple Hills, MD (MT, ND)
- EFCO USA, Inc., Charlotte, NC (P, S, V, VM, VS)
- Elcometer, Inc., Warren, MI (CP, CT, C, EC, E, ND, U, UC)



# Got radiation? See what you've been missing



## Imaging in radiation environments just got easier

With superior capabilities for operating in radiation environments, the MegaRAD cameras provide excellent image quality well beyond dose limitations of conventional cameras, and are well suited for radiation hardened imaging applications



**MegaRAD3** produce color or monochrome video up to  $3 \times 10^6$  rads total dose



**MegaRAD10** produce color or monochrome video up to  $1 \times 10^7$  rads total dose



**KiloRAD PTZ** radiation resistant camera with Pan/Tilt/Zoom

### In the United States:

For customer service, call 1-800-888-8761  
To fax an order, use 1-315-451-9421  
Email: [sales.cidtec@thermofisher.com](mailto:sales.cidtec@thermofisher.com)

### International:

For customer service, call [01] 315-451-9410  
To fax an order, use [01] 315-451-9421  
Email: [sales.cidtec@thermofisher.com](mailto:sales.cidtec@thermofisher.com)

Find out more at [thermofisher.com/cidtec](http://thermofisher.com/cidtec)

**ThermoFisher**  
SCIENTIFIC

- ◆ F&J SPECIALTY PRODUCTS, INC., Ocala, FL (E, HE)
- ◆ Framatome Inc., (North American Headquarters), Lynchburg, VA (A, EC, EM, ES, IC, M, MT, ND, PH, P, PA, S, SC, U, V, VM, VS, V)
- GE Hitachi Nuclear Energy, Wilmington, NC (A, CS, CP, CT, C, EC, EM, ES, E, FD, FO, HE, II, IC, LR, M, MT, ND, PH, P, PA, RT, S, SC, U, UC, VL, V, VM, VS, V)
- GLSEQ, LLC, Huntsville, AL (EM, ES, FO, RT)
- Heat Exchanger Products Corp. (HEPCO), Hingham, MA (VL)
- ◆ HI-Q Environmental Products Co., Inc., San Diego, CA (E, IC)
- Hoskin Scientific, Oakville, Ontario, Canada (V)
- Hydro, Inc., (HydroAire Services Division), Chicago, IL (V)
- James Fisher Technologies, Loveland, CO (EC, U)
- Leak Testing Specialists, Inc., Orlando, FL (ND)
- Mechanical Solutions, Inc., Whippany, NJ (V)
- Mirion Technologies (Canberra) Inc., Meriden, CT (E, M, ND, P, S)
- ◆ Mirion Technologies (IST) Corp., (Sensing Systems Div.), Horseheads, NY (RT)
- Mirion Technologies, Inc., (Sensing Systems Div.), Atlanta, GA (RT)
- Mitsubishi Nuclear Energy Systems, Inc., (A Sub. of Mitsubishi Heavy Industries, Ltd.), Charlotte, NC (A, CS, CP, CT, C, EC, EM, ES, E, FD, FO, HE, II, IC, LR, M, MT, ND, PH, P, PA, RT, S, SC, U, UC, VL, V, VM, VS, V)
- ◆ Netzsch Instruments North America LLC, Burlington, MA (MT, ND)
- Newton Research Labs, Inc., Renton, WA (EC, ND, U)
- Nextteq International LLC, Tampa, FL (E, P)
- ◆ NUCON International, Inc., Columbus, OH (HE)
- ◆ OTEK Corp., Tucson, AZ (IC, PH)
- PAR Systems, LLC, Saint Paul, MN (A, ND, U)
- Perma-Fix Environmental Services, Inc., Oak Ridge, TN (E, IC)
- ◆ Radiation Safety & Control Services, Inc., Seabrook, NH (E)
- ◆ RdF Corporation, Hudson, NH (IC, RT)
- River Technologies, LLC, Forest, VA (EC, HE)
- Rogante Engineering Office, Civitanova Marche, Italy (C, MT, ND)
- Schulz Electric, Timken Power Systems, East Haven, CT (EM)
- Southwest Research Institute, San Antonio, TX (MT, ND)
- Technical Associates, (a Div. of US Nuclear Corp.), Canoga Park, CA (E, IC, P)
- Teledyne Brown Engineering, Inc., Huntsville, AL (VM)
- Temp-Pro Inc., Northampton, MA (RT)
- THERMOCOAX Inc., Alpharetta, GA (RT)
- THERMOCOAX SAS, Caligny, France (RT)
- Toshiba America Energy Systems Corp., West Allis, WI (IC)
- Trillium Flow Technologies, (Atwood & Morrill, Batley, Blakeborough, Hiller, Hopkinsons, Red Point, SARASIN-RSBD, SEBIM, Termomeccanica Pompe, Tricentric), Houston, TX (V, VM, VS)
- ◆ Ultra Energy, (Weed Instrument), Round Rock, TX (RT)
- ◆ Valcor Engineering Corp., (Valcor Nuclear Div.), Springfield, NJ (V)
- Westinghouse Electric Co. LLC, Cranberry Township, PA (EM, RT)

### 84430 Testers, Pressure, Pipe

- ◆ Element Nuclear (NTS Labs), (Nuclear Engineering & Test Services), Huntsville, AL
- ◆ Framatome Inc., (North American Headquarters), Lynchburg, VA
- Idaho National Laboratory, Idaho Falls, ID
- Powerfect Service, Inc., Brick, NJ
- Tyne USA Inc., Jacksonville, FL

### 84550 Testing, Psychological

- Brownstone Psychological Associates, Manitowoc, WI

### 84600 Testing Services

- AI Alloy Identification (On-Site)
- BP Balance-of-Plant Systems
- C Coatings

- CR Components, Reactor
- CO Components, Other
- CS Containment Structural Integrity Testing
- CD Corrosion Detection
- EM Electric Motors
- ES Electrical Systems & Components
- EC Electromagnetic Compatibility
- EQ Environmental Qualification
- EC Equipment Condition Monitoring
- F Fatigue
- FR Fire Resistance/Flammability
- FL Flow
- FM Fracture Mechanics
- FI Fuel, Irradiated
- HT Heat Transfer, Condenser Performance
- I Infrared
- IC Instrumentation & Control
- LF Laminar Flow Facilities
- LD Leak Detection, Tube
- LN Leak, Nuclear Gauge
- LS Leak, Radioactive Sealed Source
- LR Leak-Rate, Integrated
- LL Leak-Rate, Local
- M Materials
- NA Neutron Attenuation
- ND Nondestructive
- NS Nuclear Systems
- PH Photometric Testing
- PP Plant Performance
- PL Plastics/Polymers
- PA Power Apparatus
- PC Power Condition Monitoring
- P Pumps
- QS Quality Services
- RT Resistance Temperature Detectors
- SP Sealed Sources (Pressure, Temperature)
- S Seismic
- SI Siren Systems
- SN Snubber
- SG Strain Gauge
- ST Structures
- TC Transport Containers
- TF Turbulent Flow
- U Ultrasonic
- V Vibration
- WT Wall Thinning Detection, Tube

- Alaron Nuclear Services, (Veolia Nuclear Solutions Federal Services - Alaron), Wampum, PA (C, EM, P)
- ANKUG Engineering Co., Ltd., Seoul, Korea (The Republic of) (S)
- ◆ AVANTech, LLC, Columbia, SC (ES, LF, LR, LL, M, ND, P)
- Bakelite Synthetics, Atlanta, GA (C)
- Baker Industries, a Lincoln Electric Company, Macomb, MI (CR, CO, F, IC, M, ND, QS, ST, TC, U, V)
- BHI Energy - now Westinghouse, See listing for Westinghouse Electric Co., Cranberry Township, PA (ES, IC, QS)
- BWX Technologies, Inc., Lynchburg, VA (BP, C, CR, CO, CD, EQ, FL, FM, FI, LD, LS, M, ND, SP, U, V, WT)
- CBS Nuclear Services, Inc., Matthews, NC (ES)
- CM Technologies Corp., Coraopolis, PA (BP, EM, ES, IC, ND)
- Concurrent Technologies Corporation, (Center for Advanced Nuclear Manufacturing), Johnstown, PA (AI, BP, C, CR, CO, CS, CD, EC, EQ, FM, M, ND, QS, RT, SP, S, ST, V)
- Consolidated Power Supply, (Div. of Consolidated Pipe & Supply Co., Inc.), Birmingham, AL (F, FM, WT)
- ◆ Constellation PowerLabs, Coatesville, PA (BP, CO, ES, EC, EQ, EC, F, FL, FM, HT, I, IC, LF, LR, LL, M, ND, PH, PL, QS, RT, SP, TF, U, V)
- Container Products Corporation, Wilmington, NC (TC)
- Croft Associates Ltd, Abingdon, Oxfordshire, United Kingdom (LS, LR, LL, TC)
- ◆ Curtiss-Wright EST Group, Hatfield, PA (LD)
- ◆ Curtiss-Wright Nuclear Division, Brea, CA (BP, C, CR, CO, CD, EM, ES, EQ, EC, F, I, IC, LD, LL, M, NA, ND, NS, PP, PL, QS, S, ST, U, V, WT)
- Curtiss-Wright Nuclear Division, Anatec, Brea, CA (BP, EC, F, LD, ND, QS, U, WT)
- Curtiss-Wright Nuclear Division, LMT, Hutchinson, MN (BP, C, CR, CO, CD, EC, F, IC, ND, QS, U)

- Curtiss-Wright Nuclear Division, NETCO, Danbury, CT (M, NA, ND, PL)
- Curtiss-Wright Nuclear Division, QualTech NP, Cincinnati, OH (CO, EM, ES, EQ, I, IC, LL, PP, QS, S, ST, V)
- Curtiss-Wright Nuclear Division, Scientech, Idaho Falls, ID (BP, CR, CO, EQ, NS, S)
- ◆ Dominion Engineering, Inc., Reston, VA (C, CD, FI, M)
- Electrical Builders Inc. (EBI), St. Cloud, MN (CO, ES, I)
- ◆ Element Nuclear (NTS Labs), (Nuclear Engineering & Test Services), Huntsville, AL (C, CR, CO, EM, ES, EC, EQ, F, HT, IC, M, ND, NS, QS, S, SN, SG, V)
- Ellis & Watts Global Industries, Inc., (a sub. of Marmont, a Berkshire Hathaway company), Batavia, OH (BP, CO, EM, ES, EC, EQ, FL, HT, IC, LD, P, S, V)
- ◆ EnergySolutions, Salt Lake City, UT (NS)
- ◆ Framatome Inc., (North American Headquarters), Lynchburg, VA (BP, CR, CO, CS, CD, EM, ES, EQ, EC, FR, FM, FI, HT, IC, LF, LD, LN, LR, LL, M, ND, NS, PH, PP, PA, P, QS, S, ST, U, V, WT)
- Fuel Tank Maintenance Co., LLC, Cookeville, TN (C, CD, ND, U)
- GE Hitachi Nuclear Energy, Wilmington, NC (BP, CR, CO, CS, EQ, FM, M, ND, NS, PA, V)
- Genave, Hampton, MN (SI)
- Global Quality Management Advisors, Lynchburg, VA (S)
- GLSEQ, LLC, Huntsville, AL (CO, EQ, EC, ND, PC, RT, S, V)
- Hennigan Engineering LLC, Hingham, MA (LD)
- Hydro, Inc., (HydroAire Services Division), Chicago, IL (P)
- Idaho National Laboratory, Idaho Falls, ID (ND, NS)
- ILD, Inc., Baton Rouge, LA (HT)
- Imperia Engineering Partners LLC, Milford, MA (C, ND, U, WT)
- Joseph Oat Corp., Camden, NJ (BP, CO)
- Kinectrics Inc., Toronto, Ontario, Canada (AI, BP, C, CR, CO, CS, CD, EM, ES, EQ, EC, F, FL, FM, IC, LD, LN, M, ND, NS, PP, PL, PA, PC, P, QS, S, ST, U, V, WT)
- Kinometrics, Inc., Pasadena, CA (S)
- Lambda Technologies, (Surface Enhancement Technologies, LLC and Lambda Research, Inc.), Cincinnati, OH (CS, F, FM, M, SG)
- Leak Testing Specialists, Inc., Orlando, FL (LL, ND, TC)
- Lincoln Structural Solutions, Louisville, NE (C, M, ND)
- Lucideon, Schenectady, NY (C, CR, CO, CD, ES, F, FM, M, PL, P, QS, SG)
- Master-Lee Engineered Products Inc., Latrobe, PA (BP)
- Materials and Chemistry Laboratory, Inc., (MCLinc), Oak Ridge, TN (M)
- Mechanical Solutions, Inc., Whippany, NJ (P, V)
- Mirion Technologies (Canberra) Inc., Meriden, CT (M, NS)
- Mirion Technologies (MGPI H&B) GmbH, (Mirion Technologies), Munich, Germany (EC, EQ, EC, IC, NS, QS, S, V)
- Mirion Technologies, Inc., (Sensing Systems Div.), Atlanta, GA (IC, NS)
- Mitsubishi Nuclear Energy Systems, Inc., (A Sub. of Mitsubishi Heavy Industries, Ltd.), Charlotte, NC (AI, BP, C, CR, CO, CS, CD, EM, ES, EC, EQ, EC, F, FR, FL, FM, FI, HT, I, IC, LF, LD, LN, LS, LR, LL, M, NA, ND, NS, PH, PP, PL, PA, PC, P, QS, RT, SP, S, SI, SN, SG, ST, TC, TF, U, V, WT)
- National Inspection & Consultants, Fort Myers, FL (M, ND)
- ◆ Netzsch Instruments North America LLC, Burlington, MA (F, FR, IC, M, ND)
- Newton Research Labs, Inc., Renton, WA (CD, U)
- NSL Analytical Services, Inc., Cleveland, OH (C, F, M, PL)
- NSSI/Recovery Services Inc., Houston, TX (SP, TC)
- Nucleonova S.L., Valencia, Spain (QS)
- ◆ NUCON International, Inc., Columbus, OH (BP, CO, LD)
- Pajarito Scientific Corp., Santa Fe, NM (ND, NS)
- ◆ Paragon Energy Solutions, (Paragon), Fort Worth, TX (EM, ES, EC, EQ, IC, M, ND, QS, S)



# ELEMENT NUCLEAR YOUR CENTER OF EXCELLENCE RESOURCE

The Element Nuclear Center of Excellence located in Huntsville, AL is the undisputed leader in nuclear testing. NTS offers equipment qualification (IEEE & ASME QME-1), safety relief valve testing/refurbishment, snubber services, and third-party qualification. Plus, Element Nuclear is the global supplier for Yokogawa instruments and replacement parts as well as the first lab in the US to receive the IEEE ICAP 3-star rating.

We're proud to be part of the unrivaled Element family with more than 8,500 experts across 260 locations in 30 nations worldwide.

CONTACT ELEMENT NUCLEAR — YOUR CENTER OF EXCELLENCE RESOURCE.

+1 888 786 7555

CONTACT.US@ELEMENT.COM

ELEMENT.COM

- PMT Nuclear, Woodridge, IL (BP, EQ, FR, FL, HT, IC, LL, M, P, S, V)
- ◆ Radiation Safety & Control Services, Inc., Seabrook, NH (CD, LS)
  - ◆ RdF Corporation, Hudson, NH (IC) Rogante Engineering Office, Civitanova Marche, Italy (C, M, ND, PL, U) Schulz Electric, Timken Power Systems, East Haven, CT (EM, ES, I, ND, PA, V) SGS North America Inc., Vallejo, CA (ND, PC) J. L. Shepherd & Assoc., San Fernando, CA (SP, TC) SIET, Piacenza, Italy (BP, CR, CO, FL, HT, LF, PP, P, QS, TF) SKODA JS a.s., Plzen, Bolevec, Czech Republic (The) (CR, FM, ND, U) Sonic Systems International, LLC, Houston, TX (BP, C, CR, CO, CD, ND, QS, SN, U) Southwest Research Institute, San Antonio, TX (C, CO, CD, ES, EQ, EC, F, FR, FL, FM, M, ND, SP, S, ST, TC, V, WT)
  - ◆ System One, Pittsburgh, PA (ND) Teledyne Brown Engineering, Inc., Huntsville, AL (LS, SG)
  - ◆ Thermal Engineering International (TEi), Cerritos, CA (HT) Toshiba America Energy Systems Corp., West Allis, WI (AI, C, CR, CD, EM, EQ, EC, F, FR, FL, FM, IC, M, ND, NS, P, QS, RT, SP, S, U, V) Transco Products Inc., Streator, IL (FR)
  - ◆ Ultra Energy, (Weed Instrument), Round Rock, TX (RT) University of Bristol, (Interface Analysis Centre) (South West Nuclear Hub), Bristol, United Kingdom (C, CD, FM, M, ND, U) USERS Corp., Daejeon, Korea (The Republic of) (EC) Veolia Nuclear Solutions - Federal Services, Piketon, OH (C, CD, EQ, IC, LS) Vysus Group, Houston, TX (EC, F, FM, PP) Westinghouse Electric Co. LLC, Cranberry Township, PA (BP, CR, CD, EM, ES, EQ, EC, FL, FI, IC, LD, NA, ND, P, QS, S, U)
  - ◆ Westinghouse Electric Company LLC, (Westinghouse Parts Business), New Stanton, PA (EM, EC, EQ, S)

### 85000 Thermocouples

- ◆ Curtiss-Wright Nuclear Division, Brea, CA Curtiss-Wright Nuclear Division, QualTech NP, Cincinnati, OH
- ◆ Framatome Inc., (North American Headquarters), Lynchburg, VA GE Hitachi Nuclear Energy, Wilmington, NC
- ◆ Mirion Technologies (IST) Corp., (Sensing Systems Div.), Horseheads, NY Mirion Technologies, Inc., (Sensing Systems Div.), Atlanta, GA
- ◆ Paragon Energy Solutions, (Paragon), Fort Worth, TX
- ◆ RdF Corporation, Hudson, NH Temp-Pro Inc., Northampton, MA THERMOCOAX Inc., Alpharetta, GA THERMOCOAX SAS, Caligny, France
- ◆ Westinghouse Electric Company LLC, (Westinghouse Parts Business), New Stanton, PA

### 85200 Thermoelectric Devices

- ◆ RdF Corporation, Hudson, NH THERMOCOAX Inc., Alpharetta, GA THERMOCOAX SAS, Caligny, France

### 85400 Thermoelectric Materials

- ◆ RdF Corporation, Hudson, NH

### 85700 Thermowells, Resistance Temperature Detector

- ◆ Curtiss-Wright Nuclear Division, Brea, CA Curtiss-Wright Nuclear Division, QualTech NP, Cincinnati, OH
- ◆ DuBose National Energy Services, Inc., Clinton, NC
- ◆ Framatome Inc., (North American Headquarters), Lynchburg, VA Mirion Technologies (IST Canada) ULC, (Formerly Mirion Technologies (IST Canada) Inc.), Cambridge, Ontario, Canada

- ◆ Mirion Technologies (IST) Corp., (Sensing Systems Div.), Horseheads, NY Mirion Technologies, Inc., (Sensing Systems Div.), Atlanta, GA NuSource LLC, Alexandria, VA
- ◆ Paragon Energy Solutions, (Paragon), Fort Worth, TX
- ◆ RdF Corporation, Hudson, NH Temp-Pro Inc., Northampton, MA THERMOCOAX Inc., Alpharetta, GA THERMOCOAX SAS, Caligny, France Tioga Pipe, Philadelphia, PA
- ◆ Ultra Energy, (Weed Instrument), Round Rock, TX Westinghouse Electric Co. LLC, Cranberry Township, PA
- ◆ Westinghouse Electric Company LLC, (Westinghouse Parts Business), New Stanton, PA

### 86000 Tissue-Equivalent Materials

- Hopewell Designs, Inc., Alpharetta, GA

### 86130 Tools

- |    |                                  |
|----|----------------------------------|
| C  | Custom-Made                      |
| D  | Drop Prevention                  |
| E  | Electric                         |
| F  | FME                              |
| F  | FOSAR Retrieval                  |
| H  | Hydraulic                        |
| P  | Pneumatic                        |
| SD | Stud Drive (for Reactor Closure) |
| VA | Vacuum-Assisted                  |
- AECON-WACHS, (U.S. Div. of Aecon Nuclear), Jackson, SC (C, E, H, P)
- ◆ Alphasource, Inc., Philadelphia, PA (F, F) ATS Industrial Automation, Inc. - Nuclear (UK), Blaby, Leicestershire, United Kingdom (C, E, H, P) ATS Industrial Automation, Inc. Nuclear (Canada), Cambridge, Ontario, Canada (C, E, H, P) Babcock Services, Inc., Kennewick, WA (C, H) Baker Industries, a Lincoln Electric Company, Macomb, MI (C, E, H, P) Bilfinger Noell GmbH, (Dept. BEV), Wuerzburg, Germany (C) Carolina Fabricators, West Columbia, SC (C) Coastel Cable Tools, Inc., East Syracuse, NY (C, E) Concurrent Technologies Corporation, (Center for Advanced Nuclear Manufacturing), Johnstown, PA (C)
  - ◆ Curtiss-Wright Nuclear Division, Brea, CA (C, E, H, P, SD) Curtiss-Wright Nuclear Division, Nova, Middleburg Heights, OH (SD) Curtiss-Wright Nuclear Division, QualTech NP, Cincinnati, OH (C, E, H, P) Curtiss-Wright Nuclear Division, Scientech, Idaho Falls, ID (C, E, H, P, SD) Desco Mfg. Co., Inc., Rancho Santa Margarita, CA (C, E, F, P, VA) E.H. Wachs, (A Div. of ITW), Lincolnshire, IL (C, E, H, P) EFCO USA, Inc., Charlotte, NC (C, E, P) Encorus Group, Springville, NY (C)
  - ◆ Framatome Inc., (North American Headquarters), Lynchburg, VA (C, E, H, P) General Plastics Mfg. Co., Tacoma, WA (C) In-Place Machining Company, LLC, Blue Ash, OH (C) Integra Services Technologies Inc., Sarnia, Ontario, Canada (H, SD) James Fisher Technologies, Loveland, CO (C, E, H, P) JNT Technical Services Inc., Little Ferry, NJ (C) Kinectrics Inc., Toronto, Ontario, Canada (C) Master-Lee Engineered Products Inc., Latrobe, PA (C, E, H, P, SD) Mega-Tech Services, LLC, Cooksburg, PA (H) Merrick & Company, Greenwood Village, CO (C) Nuclear Energy Components Ltd, Hope Valley, Derbyshire, United Kingdom (C) PAR Systems, LLC, Saint Paul, MN (C, E)
  - ◆ Petersen Inc. (A Precinmac Company), Ogden, UT (C)
  - ◆ Radiation Safety & Control Services, Inc., Seabrook, NH (C) Robotel Technologies, LLC, Roanoke, VA (C, P)

- Roberts Engineering Services, Inc., Stuart, FL (C, H, P) Scientific Sales, Inc., Oak Ridge, TN (D, E, H) Siempelkamp NIS, Alzenau, Germany (C, E, H, P) Toshiba America Energy Systems Corp., West Allis, WI (E, H, SD)

### 86150 Torque Indicators

- ◆ Framatome Inc., (North American Headquarters), Lynchburg, VA NuVision-HWM, (Wälischmiller Engineering), Pittsburgh, PA

### 86200 Towers, Cooling

- Cooling Technology Institute, Houston, TX
- ◆ Curtiss-Wright Nuclear Division, Brea, CA Curtiss-Wright Nuclear Division, QualTech NP, Cincinnati, OH
- ◆ Framatome Inc., (North American Headquarters), Lynchburg, VA Scientific Sales, Inc., Oak Ridge, TN Tower Performance LLC, Houston, TX

### 86250 Trailers, Spent-Fuel Transport

- ◆ Framatome Inc., (North American Headquarters), Lynchburg, VA Orano USA, Bethesda, MD

### 86260 Trailers, Transport

- ◆ Barnhart Nuclear Services, Fairhope, AL
- ◆ EnergySolutions, Salt Lake City, UT
- ◆ Framatome Inc., (North American Headquarters), Lynchburg, VA
- ◆ UniTech Services Group, Inc., (Div. of UniFirst Corp.), Longmeadow, MA

### 86300 Training

- |    |  |
|----|--|
| AT | Air Treatment                              |
| AC | Auditing, Codes & Standards                |
| AE | Auditing, Environmental                    |
| CH | Chemistry                                  |
| C  | Communications                             |
| CP | Computer Users/Computer Personnel          |
| CM | Construction Management Personnel          |
| CS | Crane & Rigging Safety                     |
| D  | Decommissioning                            |
| EP | Emergency Planning & Response              |
| EM | Engineering Management                     |
| EE | Engineers, Electrical                      |
| ME | Engineers, Mechanical                      |
| ES | Engineers, Structural                      |
| EL | Environmental Laws & Regulation            |
| EQ | Equipment Qualification                    |
| FP | Fire Protection                            |
| FD | Fitness-for-Duty, Behavioral Observation   |
| FC | Fuel Cycle/Performance Analysis            |
| FT | Fuel Transport/Storage                     |
| HP | Human Performance                          |
| HV | HVAC Maintenance                           |
| I  | Instructors, Classroom & Simulator         |
| LD | Leadership Development                     |
| L  | Licensing                                  |
| M  | Maintenance                                |
| MN | Management                                 |
| NT | Nondestructive Testing                     |
| NO | Nuclear Power Plant Operations Personnel   |
| OE | Organizational Effectiveness               |
| OS | OSHA Compliance                            |
| P  | Plant Commissioning                        |
| PC | Process Control Statistical                |
| PM | Project Management                         |
| QA | Quality Assurance/Quality Control          |
| RM | Radiation Management (ALARA)               |
| RP | Radiation Protection                       |
| RC | Radiochemistry                             |
| RA | Reliability Analysis                       |
| RR | Research Reactor Utilization & Maintenance |
| RS | Respiratory Protection                     |
| RT | Root Cause Analysis                        |
| SE | Safety Evaluation                          |
| S  | Scaffolding                                |
| SP | Security Personnel                         |
| SQ | Seismic Qualification                      |
| SI | Simulator, Power Plant & Reactor           |
| SG | Simulators, Gas Detection                  |
| SR | Simulators, Radiation                      |
| SW | Simulators, Web-Based                      |
| SM | Snubber Maintenance & Overhaul             |

◆ Denotes advertiser—see Index to Advertisers on pages 8–14

TB Team Building  
 TE Technicians, Electrical  
 TI Technicians, Instrumentation & Control  
 TL Technicians, Laboratory  
 TM Technicians, Mechanical  
 TS Technicians, Security  
 WM Waste Management  
 WP Waste Packaging Transportation & Disposal  
 WC Water Chemistry  
 3G Services Company LLC, Clinton, MS (NO, SI, TE, TI, TL, TM)  
 Adam Brown Consulting, Inc., Cary, IL (QA, RT, SE)  
 Advanced Consulting Group, Inc., Chicago, IL (EM, ES, MN, PM)  
 Advanced Technologies and Laboratories (ATL) International, Inc., (wholly owned sub. of Planned Systems International, Inc.), Gaithersburg, MD (OS, PM, QA, RM, RP, RT, TE, TI, TL, TM, WM)  
 Advetage Solutions, El Segundo, CA (D, RM, RP)  
 ◆ Alphasource, Inc., Philadelphia, PA (M)  
 American DND Engineering, PC, Ellicottville, NY (ES)  
 F.N. Anderson & Assoc., Forest, VA (QA)  
 Applied Analysis Corp., Reading, PA (ME, SE)  
 Applied Science Professionals, LLC, (ASP-LLC), Salt Lake City, UT (RM, RP, RT)  
 ARES Security Corp., Vienna, VA (EP, FP, RM, SP, SW, TB)  
 Argonne National Laboratory, (EOF Div.), Lemont, IL (EM, MN, WM)  
 Arkitek Scientific, Paso Robles, CA (C)  
 ◆ AVANTech, LLC, Columbia, SC (TE, WM, WC)  
 Bertin Technologies, France (RP)  
 Bevelacqua Resources, (Radiation Protection), Owens Cross Roads, AL (EP, NO, QA, RM, RP, RS, SE, WM)  
 BHI Energy - now Westinghouse, See listing for Westinghouse Electric Co., Cranberry Township, PA (CH, CM, CS, EP, EM, EE, ME, ES, EQ, HV, I, LD, M, NO, OS, PM, QA, RM, RP, RC, RS, SE, S, TE, TI, TL, TM, WM, WC)  
 Black & Veatch, Overland Park, KS (EM, EE, ME, ES, EQ, OE, PM, QA, RT, SE, SQ)  
 ◆ Boston Government Services, LLC (BGS), Oak Ridge, TN (AC, CP, EM, SE)  
 Bureau Veritas Inspection and Insurance Co., (previously OneCIS Inspection and Insurance Co.), Lynn, MA (QA)  
 Burns & McDonnell, Kansas City, MO (EE, ME, ES, EL, FP, PM, QA)  
 Cabrera Services Inc., East Hartford, CT (RM, RP, RC)  
 Carignan & Associates LLC, Chattanooga, TN (D, PM)  
 Chesapeake Nuclear Services, Inc., Annapolis, MD (RP, RC)  
 CM Technologies Corp., Coraopolis, PA (TE, TI)  
 CPMQ Consulting, LLC, Huntsville, AL (HP, RT)  
 CTR Technical Services, Inc., Manitou Springs, CO (I)  
 ◆ Curtiss-Wright Nuclear Division, Brea, CA (CH, EP, EQ, I, L, M, NT, NO, QA, RP, RC, RA, RT, SE, SQ, TM, WM)  
 Curtiss-Wright Nuclear Division, Anatec, Brea, CA (NT)  
 Curtiss-Wright Nuclear Division, Enertech, Brea, CA (EQ, I, M, QA, TM)  
 Curtiss-Wright Nuclear Division, LMT, Hutchinson, MN (NT, QA)  
 Curtiss-Wright Nuclear Division, NETCO, Danbury, CT (WM)  
 Curtiss-Wright Nuclear Division, QualTech NP, Cincinnati, OH (EQ, M, SQ)  
 Curtiss-Wright Nuclear Division, Scientech, Idaho Falls, ID (CH, EP, EQ, I, L, M, NO, QA, RP, RC, RA, RT, SE)  
 DB2 Consulting Inc., Baltimore, Ontario, Canada (HP, MN)  
 DCS Systems, Inc., Simsbury, CT (AC, FC, QA, RT)  
 DETEK, Temple Hills, MD (NT)  
 Deytec, Inc., Ashburn, VA (AC, FP, L, SE)  
 DLE Technical Services, LLC, (BlueDragon Critical Thinking and Complex Problem Solving Workshops), Palm City, FL (RT)  
 DW James Consulting, LLC, North Oaks, MN (WM, WP)

Dynatom International GmbH, Bässersdorf, Switzerland (EQ, LD)  
 E.H. Wachs, (A Div. of ITW), Lincolnshire, IL (M, TM)  
 EFCO USA, Inc., Charlotte, NC (M)  
 Elcometer Education Institute, Warren, MI (AC, AE, QA)  
 Energy, Technology and Environmental Business Association, (ETEBA), Oak Ridge, TN (WM)  
 ◆ EnergySolutions, Salt Lake City, UT (AC, CH, EL, FT, I, OS, PM, QA, RM, RP, RC, RT, SE, TI, WM)  
 Environmental Restoration Group, Inc., Albuquerque, NM (RP)  
 ◆ EXCEL Services Corporation, Rockville, MD (AE, EM, EE, ME, ES, FP, L, M, MN, RT, SE, SP, TB)  
 F.E. Moran Special Hazard Systems, Northbrook, IL (FP)  
 ◆ Framatome Inc., (North American Headquarters), Lynchburg, VA (AC, CH, CS, EP, EM, EE, ME, FP, FC, FT, I, M, NT, NO, PM, QA, RM, RP, RC, SE, SI, TE, TI, TL, TM)  
 Global Network of Companies LLC, Johannesburg, South Africa (C, CP, HP, MN, NO)  
 Global Quality Management Advisors, Lynchburg, VA (AC, AE, CM, EM, ME, LD, MN, OE, PM, QA, RT, SQ)  
 GLSEQ, LLC, Huntsville, AL (EQ, L, SQ)  
 GSE Engineering, Systems & Simulation, (GSE Systems), Columbia, MD (EM, EE, ES, EL, EQ, FP, FC, HP, I, M, NO, OE, QA, SI, SG, SR, SW, SM, TE, TI, TL, TM)  
 GSE Solutions, (GSE Systems), Columbia, MD (FP, I, NO, TE, TI, TL, TM, WM)  
 GSE Workforce Solutions, Training Services, (Formerly known as Hyperspring), Columbia, MD (AT, AC, AE, CH, EP, EM, EE, ME, ES, EL, EQ, FP, I, LD, MN, NO, OE, OS, P, PC, PM, QA, SI, SG, SR, SW, SM)  
 Human Resources Consulting, Gallatin, TN  
 ◆ I.C.E. Service Group, Inc., Moon Township, PA (PM, WM)  
 ILD, Inc., Baton Rouge, LA (ME, NO)  
 InfoTech NorthStar, Richland, WA (EM)  
 InVizion LLC, Oak Ridge, TN (PM)  
 Jensen Hughes, Baltimore, MD (EM, EE, ME, ES, EQ, FP, QA, RA, RT, SQ)  
 KCI Engineering Consultants, Downers Grove, IL (EQ)  
 Kinectrics Inc., Toronto, Ontario, Canada (CH, D, EE, ME, EQ, L, NT, RM, RP, RC, RT, SQ, WM)  
 Kinometrics, Inc., Pasadena, CA (SQ)  
 Klein Consulting LLC, Norwich, CT (AC, QA)  
 L3Harris MAPPS Inc., (Power Systems and Simulation), Montreal, Quebec, Canada (I, NO, SI, SR)  
 Leak Testing Specialists, Inc., Orlando, FL (NT)  
 LeBlond and Associates, LLC, Libertyville, IL (I, L, QA, SE)  
 Mechanical Solutions, Inc., Whippany, NJ (ME)  
 Meridian Services Group, (formerly Work Management, Inc., and High Bridge Associates, Inc.), Chattanooga, TN (CM, EM, LD, M, MN, OE, P, PM, RT, TB)  
 METOIL, Praha, Czech Republic (The) (RC)  
 Mirion Technologies (Cabrera) Inc., Meriden, CT (NT, NO, QA, RM, RP, RC, WM)  
 Mitsubishi Nuclear Energy Systems, Inc., (A Sub. of Mitsubishi Heavy Industries, Ltd.), Charlotte, NC (AT, AC, AE, CH, C, CP, CM, CS, EP, EM, EE, ME, ES, EL, EQ, FP, FD, FC, FT, HV, I, LD, L, M, MN, NT, NO, OE, OS, P, PC, PM, QA, RM, RP, RC, RA, RR, RS, RT, SE, S, SP, SQ, SI, SR, SM, TB, TE, TI, TL, TM, TS, WM, WC)  
 ◆ NAC International Inc., Peachtree Corners, GA (FC, FT)  
 National Inspection & Consultants, Fort Myers, FL (AC, NT)  
 Neptune and Company, Inc., Lakewood, CO (QA, RM)  
 NETCO, Windsor, ME (SP, TI, TS)  
 North Wind Group, Idaho Falls, ID (AE, SE, SQ, TE, TI, TL, TM, WM)  
 NSSI/Recovery Services Inc., Houston, TX (RP)  
 Nucleonova S.L., Valencia, Spain (QA)  
 ◆ NUCON International, Inc., Columbus, OH (AT, NT)  
 ◆ Oak Ridge National Laboratory, Oak Ridge, TN (C, EM, FC, WM)  
 ORTEC, Oak Ridge, TN (RP, RC)  
 Pajarito Scientific Corp., Santa Fe, NM (QA)

◆ Paragon Energy Solutions, (Paragon), Fort Worth, TX (M)  
 PMT Nuclear, Woodridge, IL (AT, HV)  
 Power & Energy Systems Services, Oradell, NJ (CP, ME, NO, TI, TM)  
 Powerfect Service, Inc., Brick, NJ (M)  
 Prospect Law Ltd., London, United Kingdom (AE, EL, FT, OE, TB)  
 PROTEM USA LLC, Evergreen, CO (M)  
 Radiation Pros, LLC, (dba Rad Pros), Englewood, CO (WM, WP)  
 ◆ Radiation Safety & Control Services, Inc., Seabrook, NH (RM, RP, SR)  
 Radiological Solutions Inc., Rockdale, IL (CH, RC, WC)  
 Red Wolf Associates, Cary, NC (EQ, LD, MN, TB)  
 ReNuke, Oak Ridge, TN (OS, RM, RS, SE, WM)  
 Right Brain Sekurity, Oswego, IL (SP)  
 ROPA Technologies Inc., Kincardine, Ontario, Canada (HP)  
 SGS North America Inc., Vallejo, CA (M, NT, TL)  
 Siempelkamp NIS, Alzenau, Germany (D, EQ, TE, TM)  
 SimGenics Simulation Systems LLC, Southlake, TX (SI)  
 Howard L. Sobel, P.E., Oceanside, NY (FC, QA, WM)  
 Sonic Systems International, LLC, Houston, TX (NT, QA)  
 Southwest Research Institute, San Antonio, TX (EL, FP, I, RP, RA)  
 Special Electronics & Designs Inc., (SED Inc.), Kincardine, Ontario, Canada (HP)  
 Studsvik Scandpower Inc., Wilmington, NC (FC)  
 Success Staging International, LLC, Evans, GA (PM, QA)  
 ◆ System One, Pittsburgh, PA (NT, OS, QA, SE)  
 Tetra Tech Inc., Richland, WA (AC, AE, D, EL, EQ, PM, QA, RM, RP, WM)  
 The Delphi Groupe, Inc., Austin, TX (AC, AE, CH, EP, EL, FP, PM, QA, RM, RP, RC, RS, TL, WM, WC)  
 ◆ Thermal Engineering International (TEi), Cerritos, CA (NO)  
 TLG Services, LLC, (sub. of Energy Corp.), Bridgewater, CT (D)  
 Toshiba America Energy Systems Corp., West Allis, WI (AC, CP, CM, EM, I, M, NT, PM, QA, RM)  
 Transco Products Inc., Streator, IL (FP)  
 TransWare Enterprises Inc., St. Louis, MO (FT)  
 Tri Nuclear Corp., Troy, NY (I)  
 University of Bristol, (Interface Analysis Centre) (South West Nuclear Hub), Bristol, United Kingdom (CH, ME, ES, EL, LD, NT, WM)  
 UxC, LLC, Roswell, GA (FC, FT, RR)  
 vgbe energy service GmbH, Essen, Germany (EM)  
 Volian Enterprises, Inc., Murrysville, PA (AC, EP, EM, EE, ME, FD, I, NO, PC, SE)  
 Westinghouse Electric Co. LLC, Cranberry Township, PA (CH, CM, CS, EP, EM, EE, ME, ES, EQ, FC, FT, HV, I, LD, M, NT, NO, OS, PM, QA, RM, RP, RC, RS, RT, SE, S, SI, TE, TI, TL, TM, WM, WC)  
 ◆ WMG, Inc., Peekskill, NY (AC, CP, EL, WM)

86400 Training Centers, Facilities

3G Services Company LLC, Clinton, MS  
 Elcometer Education Institute, Warren, MI  
 ◆ Framatome Inc., (North American Headquarters), Lynchburg, VA  
 GE Hitachi Nuclear Energy, Wilmington, NC  
 Global Network of Companies LLC, Johannesburg, South Africa  
 GSE Engineering, Systems & Simulation, (GSE Systems), Columbia, MD  
 GSE Workforce Solutions, Training Services, (Formerly known as Hyperspring), Columbia, MD  
 L3Harris MAPPS Inc., (Power Systems and Simulation), Montreal, Quebec, Canada  
 Leak Testing Specialists, Inc., Orlando, FL  
 Mitsubishi Nuclear Energy Systems, Inc., (A Sub. of Mitsubishi Heavy Industries, Ltd.), Charlotte, NC  
 ◆ Radiation Safety & Control Services, Inc., Seabrook, NH  
 Technical Management Services, Inc., New Hartford, CT

**86500 Training Materials, Courseware**

- AV Audio-Visual Aids  
CA Computer-Aided  
DV Digital Video, Interactive  
M Models, Mockups  
T Textual
- ARES Security Corp., Vienna, VA (M)  
Arkitek Scientific, Paso Robles, CA (AV, CA, DV, M)  
ASQ Energy & Environmental Division, Milwaukee, WI (CA, DV, T)  
Bevelacqua Resources, (Radiation Protection), Owens Cross Roads, AL (T)  
BHI Energy - now Westinghouse, See listing for Westinghouse Electric Co., Cranberry Township, PA (AV, M)  
♦ Curtiss-Wright Nuclear Division, Brea, CA (M)  
Curtiss-Wright Nuclear Division, EnerTech, Brea, CA (M)  
Deytec, Inc., Ashburn, VA (AV, CA, T)  
Elcometer Education Institute, Warren, MI (T)  
♦ EnergySolutions, Salt Lake City, UT (AV, CA, DV, T)  
♦ Framatome Inc., (North American Headquarters), Lynchburg, VA (AV, CA, M, T)  
GSE Engineering, Systems & Simulation, (GSE Systems), Columbia, MD (AV, CA, M)  
GSE Solutions, (GSE Systems), Columbia, MD (AV, CA, DV, M, T)  
GSE Workforce Solutions, Training Services, (Formerly known as Hyperspring), Columbia, MD (AV, CA, DV, M, T)  
LBHarris MAPPS Inc., (Power Systems and Simulation), Montreal, Quebec, Canada (AV, CA)  
LeBlond and Associates, LLC, Libertyville, IL (CA, T)  
Navarro, Oak Ridge, TN (AV, CA, DV, M, T)  
PMT Nuclear, Woodridge, IL (M)  
Power & Energy Systems Services, Oradell, NJ (AV, T)  
♦ Preferred Engineering Corp., (Sub. of Preferred Utilities Mfg. Corp.), Danbury, CT (M)  
Siempelkamp NIS, Alzenau, Germany (M)  
SimGenics Simulation Systems LLC, Southlake, TX (DV, M)  
Southwest Research Institute, San Antonio, TX (AV, CA, DV, M, T)  
Success Staging International, LLC, Evans, GA (AV, CA, DV, M, T)  
Technical Management Services, Inc., New Hartford, CT (T)  
Theseus Quality Assurance, LLC, Richland, WA (CA)  
Volian Enterprises, Inc., Murrysville, PA (T)  
Westinghouse Electric Co. LLC, Cranberry Township, PA (AV, M)  
♦ WMG, Inc., Peekskill, NY (AV, CA, DV, T)

**86750 Transducers**

- D Displacement  
FW Force & Weight  
P Pressure  
PT Pressure/Temperature  
T Temperature
- ♦ Constellation PowerLabs, Coatesville, PA (D, FW, P, PT, T)  
♦ Curtiss-Wright Nuclear Division, Brea, CA (FW, P, PT, T)  
Curtiss-Wright Nuclear Division, QualTech NP, Cincinnati, OH (FW, P, PT, T)  
Joseph Oat Corp., Camden, NJ (D, FW, P, T)  
Kanata Electronic Services Ltd., (Div. of Shawcor Ltd.), Toronto, Ontario, Canada (PT)  
♦ Paragon Energy Solutions, (Paragon), Fort Worth, TX (P, PT, T)  
PMT Nuclear, Woodridge, IL (FW, P, T)  
Pyragon Electronic Instrumentation, Rochester, NY (P, PT, T)  
♦ RdF Corporation, Hudson, NH (T)  
THERMOCOAX Inc., Alpharetta, GA (T)  
THERMOCOAX SAS, Caligny, France (T)  
Toshiba America Energy Systems Corp., West Allis, WI (P, PT)  
♦ Ultra Energy, (Weed Instrument), Round Rock, TX (PT, T)  
Westinghouse Electric Co. LLC, Cranberry Township, PA (P, PT, T)

- ♦ Westinghouse Electric Company LLC, (Westinghouse Parts Business), New Stanton, PA (P, PT, T)

**86800 Transfer Systems for Irradiation Samples**

- H Hydraulic  
P Pneumatic
- ATS Industrial Automation, Inc. - Nuclear (UK), Blaby, Leicester, United Kingdom (H)  
ATS Industrial Automation, Inc. Nuclear (Canada), Cambridge, Ontario, Canada (H)  
Hopewell Designs, Inc., Alpharetta, GA (P)

**86870 Transformers**

- CP Control, Power  
D Dry Type  
LV Linear Variable Differential
- Basic E, Inc., Charlotte, VT (CP, LV)  
CBS Nuclear Services, Inc., Matthews, NC (CP, D)  
♦ Curtiss-Wright Nuclear Division, Brea, CA (CP, D, LV)  
Curtiss-Wright Nuclear Division, QualTech NP, Cincinnati, OH (CP, D, LV)  
♦ Paragon Energy Solutions, (Paragon), Fort Worth, TX (CP, D)  
PMT Nuclear, Woodridge, IL (D)  
Westinghouse Electric Co. LLC, Cranberry Township, PA (CP, D)  
♦ Westinghouse Electric Company LLC, (Westinghouse Parts Business), New Stanton, PA (CP, D, LV)

**86900 Translation Services**

- EmmEn Marketing Consultants, Pune, Maharashtra, India  
Interdevelopment, Inc., Falls Church, VA

**86970 Transmitters**

- E Electronic  
LL Level, Liquid  
ME Measurement  
MI Microwave  
PR Pressure  
PD Pressure Differential
- Basic E, Inc., Charlotte, VT (E, LL, ME, PR, PD)  
♦ Curtiss-Wright Nuclear Division, Brea, CA (E, LL, ME, PR, PD)  
Curtiss-Wright Nuclear Division, QualTech NP, Cincinnati, OH (E, LL, ME, PR, PD)  
♦ Element Nuclear (NTS Labs), (Nuclear Engineering & Test Services), Huntsville, AL (E, LL, ME, PR, PD)  
FCI-Fluid Components International, San Marcos, CA (LL, ME)  
Kanata Electronic Services Ltd., (Div. of Shawcor Ltd.), Toronto, Ontario, Canada (PR)  
KROHNE, (KROHNE Nuclear), Romans-sur-Isère, France (LL, ME, PR, PD)  
Mirion Technologies, Inc., (Sensing Systems Div.), Atlanta, GA (E)  
♦ Paragon Energy Solutions, (Paragon), Fort Worth, TX (E, LL, ME, PR, PD)  
PMT Nuclear, Woodridge, IL (LL, ME, PR)  
Rosemount Nuclear Instruments, Inc., Chanhassen, MN (LL, ME, PR, PD)  
Tyne USA Inc., Jacksonville, FL (E, LL, ME, PR, PD)  
Westinghouse Electric Co. LLC, Cranberry Township, PA (E, LL, ME, PR, PD)  
♦ Westinghouse Electric Company LLC, (Westinghouse Parts Business), New Stanton, PA (E, LL, ME, MI, PR, PD)

**87000 Transport Services**

- C Consulting/Transport Management  
DC Dry Cask  
HC Heavy Components  
IR Intermodal/Rail  
L Liners  
HL Radioactive, High-Level  
LL Radioactive, Low-Level  
R Regulation  
S Safety  
TP Transload Facility, Permanent  
TT Transload Facility, Temporary  
U UF6/U3O8  
VC Vertical Cask

- Accelerated Decommissioning Partners - ADP, Dallas, TX (DC, HL, LL)  
Alaron Nuclear Services, (Veolia Nuclear Solutions Federal Services - Alaron), Wampum, PA (C, HC, IR, L, LL, TP, TT)  
♦ American DND Inc., Grand Island, NY (C)  
♦ AVANTech, LLC, Columbia, SC (L)  
♦ Barnhart Nuclear Services, Fairhope, AL (HC, IR, LL)  
Croft Associates Ltd, Abingdon, Oxfordshire, United Kingdom (L, HL, LL)  
CS-2 Inc., Grand Island, NY (C)  
Dufrane Nuclear Shielding Inc., (Dufrane Nuclear Inc.), Winsted, CT (C, IR)  
DW James Consulting, LLC, North Oaks, MN (C)  
Ebersen, Inc., Minneapolis, MN (HC)  
♦ EnergySolutions, Salt Lake City, UT (C, HC, IR, L, HL, LL)  
♦ Framatome Inc., (North American Headquarters), Lynchburg, VA (C, HC, IR, HL, LL, U)  
General Plastics Mfg. Co., Tacoma, WA (L)  
GNS Gesellschaft für Nuclear-Service mbH, Essen, Germany (C, DC, HL)  
♦ I.C.E. Service Group, Inc., Moon Township, PA (C, DC, HC, IR, L, HL, LL, TP, TT, U)  
Kinectrics Inc., Toronto, Ontario, Canada (C, L, LL)  
Konecranes Nuclear Equipment & Services LLC, (Formerly Morris Material Handling / P&H), New Berlin, WI (DC)  
Landstar, Burlington, KY (C, DC, HC, L, LL)  
Longenecker & Associates, Inc., Las Vegas, NV (C)  
♦ NAC International Inc., Peachtree Corners, GA (C, DC, IR, HL, LL)  
NAC Philotechnics, Ltd., Oak Ridge, TN (C, LL)  
North Wind Group, Idaho Falls, ID (C, IR)  
NSSI/Recovery Services Inc., Houston, TX (C, LL)  
Nuclear Transport Solutions, Warrington, United Kingdom (C, DC, HC, IR, L, HL, LL, R, S, U, VC)  
Orano Decommissioning Services, Hudson, MA (DC, HL, LL)  
Orano TN, Columbia, MD (C, DC, IR, HL, LL)  
Orano USA, Bethesda, MD (C, DC, IR, HL, LL, U)  
♦ PacTec, Inc., Clinton, LA (LL)  
♦ Petersen Inc. (A Precinmac Company), Ogden, UT (HC, U)  
Prospect Law Ltd., London, United Kingdom (C)  
PTP Spent Fuel Services, LLC, Grand Island, NY (C, HC, IR, LL, S, VC)  
Republic Services, Livonia, MI (LL)  
Sarens Nuclear & Industrial Services LLC, (Sarens), Houston, TX (C, HC, IR)  
♦ Strategic Packaging Systems, (I.C.E. Packaging Company, LLC), Madisonville, TN (C, HC, IR, L, HL, LL, R, S, U, VC)  
VAT Group, San Jose, CA (U)  
Waste Control Specialists LLC, Andrews, TX (LL)

**87140 Trays**

- C Cable  
CV Covers  
SR Side Rails  
T Tubing
- AECON-WACHS, (U.S. Div. of Aecon Nuclear), Jackson, SC (C, CV, SR, T)  
Consolidated Power Supply, (Div. of Consolidated Pipe & Supply Co., Inc.), Birmingham, AL (C, CV, SR, T)  
♦ DuBose National Energy Services, Inc., Clinton, NC (C)  
♦ James C. White Company, Inc., Greenville, SC (C, CV, SR, T)  
♦ Mirion Technologies (IST) Corp., (Sensing Systems Div.), Horseheads, NY (C)  
Mirion Technologies, Inc., (Sensing Systems Div.), Atlanta, GA (C)  
♦ Paragon Energy Solutions, (Paragon), Fort Worth, TX (C)  
♦ Westinghouse Electric Company LLC, (Westinghouse Parts Business), New Stanton, PA (C, CV, SR, T)

**87380 Tritium Handling Equipment**

- ATS Industrial Automation, Inc. - Nuclear (UK), Blaby, Leicester, United Kingdom  
ATS Industrial Automation, Inc. Nuclear (Canada), Cambridge, Ontario, Canada

◆ Denotes advertiser—see Index to Advertisers on pages 8–14

- Baker Industries, a Lincoln Electric Company, Macomb, MI
- Kinectrics Inc., Toronto, Ontario, Canada
- Ludlum Measurements, Inc., Sweetwater, TX
- ◆ Major Tool & Machine, (A Precinmac Company), Indianapolis, IN
- Merrick & Company, Greenwood Village, CO
- NSSI/Recovery Services Inc., Houston, TX
- ◆ NUCON International, Inc., Columbus, OH
- Power Generation Integrated, (PGICL), Etobicoke, Ontario, Canada
- Tyne USA Inc., Jacksonville, FL
- Veolia Nuclear Solutions - Federal Services, Piketon, OH
- ◆ Wagstaff Applied Technologies, Spokane, WA
- ◆ Westinghouse Electric Company LLC, (Westinghouse Parts Business), New Stanton, PA

**87395 Tritium Recycle & Extraction Equipment**

- Baker Industries, a Lincoln Electric Company, Macomb, MI
- ◆ Major Tool & Machine, (A Precinmac Company), Indianapolis, IN
- Merrick & Company, Greenwood Village, CO
- NSSI/Recovery Services Inc., Houston, TX
- Power Generation Integrated, (PGICL), Etobicoke, Ontario, Canada
- Tyne USA Inc., Jacksonville, FL
- ◆ Westinghouse Electric Company LLC, (Westinghouse Parts Business), New Stanton, PA

**87400 Tritium Removal Equipment**

- ATS Industrial Automation, Inc. - Nuclear (UK), Blaby, Leicester, United Kingdom
- ATS Industrial Automation, Inc. Nuclear (Canada), Cambridge, Ontario, Canada
- Baker Industries, a Lincoln Electric Company, Macomb, MI
- ISO-PACIFIC Remediation Technologies, Inc., Richland, WA

- Merrick & Company, Greenwood Village, CO
- NSSI/Recovery Services Inc., Houston, TX
- ◆ NUCON International, Inc., Columbus, OH
- Power Generation Integrated, (PGICL), Etobicoke, Ontario, Canada
- Tyne USA Inc., Jacksonville, FL
- Veolia Nuclear Solutions - Federal Services, Piketon, OH
- ◆ Westinghouse Electric Company LLC, (Westinghouse Parts Business), New Stanton, PA

**87680 Tube Extraction (Removal) Equipment**

- ATS Industrial Automation, Inc. - Nuclear (UK), Blaby, Leicester, United Kingdom
- ATS Industrial Automation, Inc. Nuclear (Canada), Cambridge, Ontario, Canada
- BWX Technologies, Inc., Lynchburg, VA
- ◆ Framatome Inc., (North American Headquarters), Lynchburg, VA

**87700 Tube Systems**

- C Commercial Grade
- S Stainless
- Carolina Fabricators, West Columbia, SC (C, S)
- Consolidated Power Supply, (Div. of Consolidated Pipe & Supply Co., Inc.), Birmingham, AL (C)
- H. Butting GmbH & Co. KG, Wittingen-Knesebeck, Germany (S)
- Neotiss, Inc., Morristown, TN (S)
- Teledyne Brown Engineering, Inc., Huntsville, AL (S)
- TW Metals - Nuclear Materials Solutions, Linden, MI (C, S)

**87900 Tubes, Electron**

- ◆ LND, Inc., Oceanside, NY

**87950 Tubes, Finned**

- ◆ Aerofin, Lynchburg, VA
- Joseph Oat Corp., Camden, NJ

- Lincoln Structural Solutions, Louisville, NE
- Neotiss, Inc., Morristown, TN
- NuSource LLC, Alexandria, VA
- PMT Nuclear, Woodridge, IL
- ◆ Super Radiator Coils, Chaska, MN
- Tioga Pipe, Philadelphia, PA
- TW Metals - Nuclear Materials Solutions, Linden, MI

**88000 Tubesheets**

- Carolina Fabricators, West Columbia, SC
- Consolidated Power Supply, (Div. of Consolidated Pipe & Supply Co., Inc.), Birmingham, AL
- ◆ Framatome Inc., (North American Headquarters), Lynchburg, VA
- Joseph Oat Corp., Camden, NJ
- Lincoln Structural Solutions, Louisville, NE
- NuSource LLC, Alexandria, VA
- PMT Nuclear, Woodridge, IL
- ◆ Precision Custom Components, LLC., (DC Fabricators), York, PA
- Premier Technology, Inc., Blackfoot, ID
- Tioga Pipe, Philadelphia, PA
- TW Metals - Nuclear Materials Solutions, Linden, MI
- ◆ Westinghouse Electric Company LLC, (Westinghouse Parts Business), New Stanton, PA

**88100 Tubing**

- CS Carbon Steel, Seamless
- HE Heat Exchanger
- S Stainless
- SS Stainless, Seamless
- SG Steam Generator
- GS Steam Generator Sleeves
- T Titanium
- TS Titanium, Seamless
- Z Zirconium Alloy
- BWX Technologies, Inc., Lynchburg, VA (CS, HE, S, SS, SG, GS, T, TS, Z)



**ICE Service Group, Inc.**  
Industrial • Construction • Environmental

**LEADING THE TRANSPORTATION & LOGISTICS INDUSTRIES**

**SINCE 2007**





**TRANSPORTATION**  
(RAIL, TRUCK, MARINE)

**HEAVY / OVER-DIMENSIONAL LOGISTICS | ON-SITE & PROJECT STAFFING | TRANSLOADING | WASTE MANAGEMENT**

**WWW.ICESERVICEGROUP.COM**

**CONTACT: DMORGAN@ICESERVICEGROUP.COM**

Carolina Fabricators, West Columbia, SC (CS, HE, S, SS, SG, GS, T, TS)  
 Consolidated Power Supply, (Div. of Consolidated Pipe & Supply Co., Inc.), Birmingham, AL (CS, S, SS, SG, GS, T, TS, Z)  
 ◆DuBose National Energy Services, Inc., Clinton, NC (CS, S, SS, SG, GS, T, TS)  
 ◆Framatome Inc., (North American Headquarters), Lynchburg, VA (S, SS, SG, GS, Z)  
 FuseRing Inc., London, Ontario, Canada (CS, S, SS, T, TS, Z)  
 GE Hitachi Nuclear Energy, Wilmington, NC (Z)  
 Joseph Oat Corp., Camden, NJ (S, SS, T, TS)  
 Lincoln Structural Solutions, Louisville, NE (CS, S, SS)  
 Neotiss, Inc., Morristown, TN (S, T)  
 NuSource LLC, Alexandria, VA (CS, HE, S, SS, T)  
 PMT Nuclear, Woodridge, IL (CS, HE, S, SS, T)  
 Tioga Pipe, Philadelphia, PA (CS, S, SS, SG, GS, T, TS, Z)  
 TW Metals - Nuclear Materials Solutions, Linden, MI (CS, S, SS, SG, GS, T, TS, Z)  
 UCC Industries International Inc., Pickering, Ontario, Canada (S, SS)  
 Westinghouse Electric Co. LLC, Cranberry Township, PA (Z)  
 ◆Westinghouse Electric Company LLC, (Westinghouse Parts Business), New Stanton, PA (CS, HE, S, SS, SG, GS, T, TS, Z)

### 88200 Tubing Clamps, Supports

C Commercial Grade  
 S Seismic

Carolina Fabricators, West Columbia, SC (C, S)  
 Consolidated Power Supply, (Div. of Consolidated Pipe & Supply Co., Inc.), Birmingham, AL (C, S)  
 ◆DuBose National Energy Services, Inc., Clinton, NC (C, S)  
 ◆James C. White Company, Inc., Greenville, SC (C, S)  
 Lincoln Structural Solutions, Louisville, NE (C)  
 NuSource LLC, Alexandria, VA (S)

UCC Industries International Inc., Pickering, Ontario, Canada (C, S)  
 ◆Westinghouse Electric Company LLC, (Westinghouse Parts Business), New Stanton, PA (C, S)

### 89400 Turbine Gears

Toshiba America Energy Systems Corp., West Allis, WI

### 89500 Turbine-Generators (Including Stators & Rotors)

BHI Energy - now Westinghouse, See listing for Westinghouse Electric Co., Cranberry Township, PA  
 Hybrid Power Technologies LLC, Overland Park, KS  
 Mitsubishi Nuclear Energy Systems, Inc., (A Sub. of Mitsubishi Heavy Industries, Ltd.), Charlotte, NC  
 Power Services Group, (Power Plant Services, Orbital Energy Services, Airco, Turbine Generator Maintenance), Cape Coral, FL  
 Toshiba America Energy Systems Corp., West Allis, WI

### 89510 Turbines, Feedwater Pump

KSB, Inc., Henrico, VA  
 Mitsubishi Nuclear Energy Systems, Inc., (A Sub. of Mitsubishi Heavy Industries, Ltd.), Charlotte, NC  
 ◆The Park Company, Pasco, WA  
 Power Services Group, (Power Plant Services, Orbital Energy Services, Airco, Turbine Generator Maintenance), Cape Coral, FL  
 Toshiba America Energy Systems Corp., West Allis, WI

### 89580 Uranium Blending

BWX Technologies, Inc., Lynchburg, VA  
 Orano USA, Bethesda, MD  
 Westinghouse Electric Co. LLC, Cranberry Township, PA

### 89590 Uranium, Depleted

Orano USA, Bethesda, MD  
 UxC, LLC, Roswell, GA

### 89600 Uranium Conversion

BWX Technologies, Inc., Lynchburg, VA  
 Orano USA, Bethesda, MD  
 UxC, LLC, Roswell, GA  
 Westinghouse Electric Co. LLC, Cranberry Township, PA

### 89640 Uranium Enrichment Exchange Services

American Centrifuge Operating, LLC, (sub. of Centrus Energy), Oak Ridge, TN

### 89650 Uranium Enrichment Services

American Centrifuge Operating, LLC, (sub. of Centrus Energy), Oak Ridge, TN  
 Ebersen, Inc., Minneapolis, MN  
 Orano USA, Bethesda, MD  
 PHDS Co., Knoxville, TN  
 Teledyne Brown Engineering, Inc., Huntsville, AL

### ◆Urenco USA (UUSA), Eunice, NM

UxC, LLC, Roswell, GA

### 89760 Uranium Exploration

Ebersen, Inc., Minneapolis, MN  
 Orano USA, Bethesda, MD  
 PHDS Co., Knoxville, TN  
 UxC, LLC, Roswell, GA

### 89795 Uranium Mining

Orano USA, Bethesda, MD  
 PHDS Co., Knoxville, TN  
 UxC, LLC, Roswell, GA

### 89800 Uranium Ore Concentrates

Orano USA, Bethesda, MD  
 UxC, LLC, Roswell, GA

## INSTRUMENTATION SUPPORT SYSTEMS

TUBETRACK® • CABLE-RACE® • TUBE & PIPE CLAMPS

Stainless Steel Tube Clamps in TubeTrack® Tray

Weld-Down Clamp Bases

- **QA Program:** 10CFR50-B / NQA-1 / ASME III NCA-3300 / CSA-N299.2
- NC & PC clamps for tubing and smaller pipe
- 3D anchor clamps or 2D guide clamps
- Weld-Down Bases, patent # 9,670,949 B1, sold separately, for precise clamp installation and replacement
- Fasteners, sold separately, connect clamps to bases

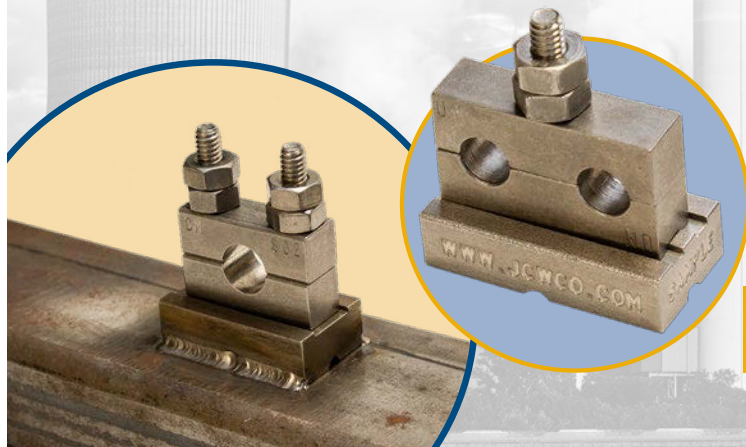

www.JCWCO.com • 800-421-9410  
 Greenville, SC • NuclearSales@JCWCO.com



James C. White Company, Inc.  
 Manufacturer of TUBETRACK®

Supporting the Nuclear Industry for over 60 years



## 90000 Vacuum Breakers

- Basic E, Inc., Charlotte, VT
- CBS Nuclear Services, Inc., Matthews, NC
- ◆ Element Nuclear (NTS Labs), (Nuclear Engineering & Test Services), Huntsville, AL
- ◆ Framatome Inc., (North American Headquarters), Lynchburg, VA
- ◆ Paragon Energy Solutions, (Paragon), Fort Worth, TX
- PMT Nuclear, Woodridge, IL
- Westinghouse Electric Co. LLC, Cranberry Township, PA
- ◆ Westinghouse Electric Company LLC, (Westinghouse Parts Business), New Stanton, PA

## 90100 Vacuum Equipment & Accessories

- Baker Industries, a Lincoln Electric Company, Macomb, MI
- Camfil USA, Inc., Washington, NC
- Coastal Network, Inc, Charlottesville, VA
- Desco Mfg. Co., Inc., Rancho Santa Margarita, CA
- Goodway Technologies, Stamford, CT
- ◆ HI-Q Environmental Products Co., Inc., San Diego, CA
- Joseph Oat Corp., Camden, NJ
- ◆ Major Tool & Machine, (A Precinmac Company), Indianapolis, IN
- Master-Lee Engineered Products Inc., Latrobe, PA
- NFT, (by Alpha Safety Group), Golden, CO
- River Technologies, LLC, Forest, VA
- ◆ Schutte and Koerting, Trevoise, PA
- Tri Nuclear Corp., Troy, NY
- ◆ Underwater Construction Corp., (Underwater Construction Corp. UK Ltd.), Essex, CT
- VAT Group, San Jose, CA

## 90250 Valve Operators (Actuators)

AP Accessories/Positioners

- A Air
- ES Electric Solenoid
- EH Electrohydraulic
- EX Explosive-Activated
- H Hydraulic
- MN Manual
- M Motor
- Basic E, Inc., Charlotte, VT (A, H, MN, M)
- BHI Energy - now Westinghouse, See listing for Westinghouse Electric Co., Cranberry Township, PA (A, M)
- ◆ Conval, Inc., Enfield, CT (A, ES, EH, H, MN, M)
- descote, Feyzin, France (A)
- Dragon Valves, Inc., Norwalk, CA (A)
- E.H. Wachs, (A Div. of ITW), Lincolnshire, IL (A, H, MN, M)
- Ellis & Watts Global Industries, Inc., (a sub. of Marmon®, a Berkshire Hathaway company), Batavia, OH (A, EH)
- Energy Steel, Rochester Hills, MI (A, H, MN, M)
- ◆ Framatome Inc., (North American Headquarters), Lynchburg, VA (A, ES, EH, H, MN, M)
- GE Hitachi Nuclear Energy, Wilmington, NC (M)
- IMI Critical Engineering, Burlington, Ontario, Canada (A, MN)
- KSB, Inc., Henrico, VA (A, MN, M)
- ◆ Mirion Technologies (IST) Corp., (Sensing Systems Div.), Horseheads, NY (EX)
- Mirion Technologies, Inc., (Sensing Systems Div.), Atlanta, GA (EX)
- ◆ Paragon Energy Solutions, (Paragon), Fort Worth, TX (A, ES, H, MN, M)
- ◆ The Park Company, Pasco, WA (A, ES, EH, MN, M)
- PMT Nuclear, Woodridge, IL (AP, A, ES, EH, H, MN, M)
- QTRCO, Inc., Tomball, TX (A, EH, H)
- Schulz Electric, Timken Power Systems, East Haven, CT (M)
- ◆ SSM Industries, Inc., (Nuclear Div.), Pittsburgh, PA (AP, A, ES, EH, H, MN, M)

- Toshiba America Energy Systems Corp., West Allis, WI (ES, M)
- ◆ Valcor Engineering Corp., (Valcor Nuclear Div.), Springfield, NJ (ES)
- Westinghouse Electric Co. LLC, Cranberry Township, PA (A, ES, EH, EX, H, MN, M)
- ◆ Westinghouse Electric Company LLC, (Westinghouse Parts Business), New Stanton, PA (AP, A, ES, EH, EX, H, MN, M)
- WTM Valves and Services - Hammel Dahl, (Div. of Wright Technical Marketing), Lewisburg, PA (AP, A)

## 90280 Valve Packing Removal Equipment

- ◆ Curtiss-Wright Nuclear Division, Brea, CA
- Curtiss-Wright Nuclear Division, AP Services, Middleburg Heights, OH
- ◆ Framatome Inc., (North American Headquarters), Lynchburg, VA
- KSB, Inc., Henrico, VA
- SERCO USA, Evergreen, CO
- Toshiba America Energy Systems Corp., West Allis, WI

## 90320 Valve-Reseating Equipment, On-line

- AECON-WACHS, (U.S. Div. of Aecon Nuclear), Jackson, SC
- EFCO USA, Inc., Charlotte, NC
- ◆ Framatome Inc., (North American Headquarters), Lynchburg, VA
- SERCO USA, Evergreen, CO
- Toshiba America Energy Systems Corp., West Allis, WI

## 90330 Valve Stem Gland Packing Systems, Live-Loaded

- BNL Industries, Inc., Vernon Rockville, CT
- Consolidated Power Supply, (Div. of Consolidated Pipe & Supply Co., Inc.), Birmingham, AL
- ◆ Curtiss-Wright Nuclear Division, Brea, CA



- ✓ **Serving America's Nuclear Power Generators**
- ✓ **Advancing Energy Security**
- ✓ **Supporting Current & Future Fuels for the Nuclear Industry**

As the only operating commercial uranium enrichment facility in North America, Ureco USA (UUSA) helps provide clean, sustainable energy while working under a framework of high environmental, social responsibility, and corporate governance standards.



urencousa.com

Curtiss-Wright Nuclear Division, AP Services, Middleburg Heights, OH  
 KSB, Inc., Henrico, VA  
 Toshiba America Energy Systems Corp., West Allis, WI  
 Westinghouse Electric Co. LLC, Cranberry Township, PA

**90600 Valves, Check, Stop Check**

- AC Air-Cylinder-Assisted
  - B Ball
  - CC Controlled-Closure
  - NS Non-Slam
  - PO Piston-Operated
  - SL Spring-Loaded
  - ST Swing Type
  - SA Swing Type, Alloy
  - TD Tilting Disk
- AECON-WACHS, (U.S. Div. of Aecon Nuclear), Jackson, SC (AC, B, CC, NS, PO, SL, ST, SA, TD)  
 Basic E, Inc., Charlotte, VT (B)  
 BHI Energy - now Westinghouse, See listing for Westinghouse Electric Co., Cranberry Township, PA (PO)  
 BNL Industries, Inc., Vernon Rockville, CT (NS, SL)  
 Consolidated Power Supply, (Div. of Consolidated Pipe & Supply Co., Inc.), Birmingham, AL (B, PO, SL, ST, SA)  
 ◆ Conval, Inc., Enfield, CT (B, PO, SL)  
 ◆ Curtiss-Wright Nuclear Division, Brea, CA (B)  
 Curtiss-Wright Nuclear Division, QualTech NP, Cincinnati, OH (B)  
 Dragon Valves, Inc., Norwalk, CA (CC, SL)  
 ◆ Framatome Inc., (North American Headquarters), Lynchburg, VA (AC, B, CC, NS, PO, SL, ST, SA, TD)  
 KSB, Inc., Henrico, VA (AC, B, CC, NS, PO, SL, ST, SA, TD)  
 NuSource LLC, Alexandria, VA (B, PO, SL)  
 ◆ Paragon Energy Solutions, (Paragon), Fort Worth, TX (B, PO, SL, ST, SA, TD)

- ◆ The Park Company, Pasco, WA (AC, B, NS, PO, SL, ST, TD)  
 PK Valve & Engineering Co., Ltd., Changwon-si, Korea (The Republic of) (SL, ST, SA)  
 ◆ Schutte and Koerting, Trevose, PA (AC, PO, ST, SA)  
 Toshiba America Energy Systems Corp., West Allis, WI (SL)  
 Trillium Flow Technologies, (Atwood & Morrill, Batley, Blakeborough, Hiller, Hopkinsons, Red Point, SARASIN-RSBD, SEBIM, Termomeccanica Pompe, Tricentric), Houston, TX (AC, CC, NS, PO, SL, ST)  
 ◆ Valcor Engineering Corp., (Valcor Nuclear Div.), Springfield, NJ (CC, PO, SL)  
 Velan Inc., Montreal, Quebec, Canada (AC, B, CC, PO, SL, ST, SA, TD)  
 Velan S.A.S., (Sub. of Velan Inc. (Canada)), Lyon Cedex 7, France (SL)  
 Westinghouse Electric Co. LLC, Cranberry Township, PA (PO, ST, SA)  
 ◆ Westinghouse Electric Company LLC, (Westinghouse Parts Business), New Stanton, PA (AC, B, CC, NS, PO, SL, ST, SA, TD)

- ◆ Curtiss-Wright Nuclear Division, Brea, CA (F, P, T)  
 Curtiss-Wright Nuclear Division, QualTech NP, Cincinnati, OH (F, P, T)  
 descote, Feyzin, France (F)  
 Dragon Valves, Inc., Norwalk, CA (F)  
 E.H. Wachs, (A Div. of ITW), Lincolnshire, IL (I, V)  
 ◆ Framatome Inc., (North American Headquarters), Lynchburg, VA (F, FA, I, P, T, V)  
 ◆ HI-Q Environmental Products Co., Inc., San Diego, CA (V)  
 IMI Critical Engineering, Burlington, Ontario, Canada (F, FA, I)  
 ◆ Mirion Technologies (IST) Corp., (Sensing Systems Div.), Horseheads, NY (F)  
 Mirion Technologies, Inc., (Sensing Systems Div.), Atlanta, GA (F)  
 NuSource LLC, Alexandria, VA (F, P)  
 ◆ Paragon Energy Solutions, (Paragon), Fort Worth, TX (F, P, T, V)  
 ◆ The Park Company, Pasco, WA (F)  
 ◆ Schutte and Koerting, Trevose, PA (F, P)  
 ◆ SSM Industries, Inc., (Nuclear Div.), Pittsburgh, PA (F)  
 Toshiba America Energy Systems Corp., West Allis, WI (F)  
 Trillium Flow Technologies, (Atwood & Morrill, Batley, Blakeborough, Hiller, Hopkinsons, Red Point, SARASIN-RSBD, SEBIM, Termomeccanica Pompe, Tricentric), Houston, TX (F, P, T)  
 Tyne USA Inc., Jacksonville, FL (F, FA, P, T, V)  
 ◆ Valcor Engineering Corp., (Valcor Nuclear Div.), Springfield, NJ (F, P, T, V)  
 VAT Group, San Jose, CA (P, V)  
 Westinghouse Electric Co. LLC, Cranberry Township, PA (F, P, T, V)  
 ◆ Westinghouse Electric Company LLC, (Westinghouse Parts Business), New Stanton, PA (F, FA, I, P, T, V)  
 WTM Valves and Services - Hammel Dahl, (Div. of Wright Technical Marketing), Lewisburg, PA (F, FA, P, T)

**90800 Valves, Control**

- F Flow
  - FA Flow, Acoustic Emission
  - I Intelligent
  - P Pressure
  - T Temperature
  - V Vacuum
- AECON-WACHS, (U.S. Div. of Aecon Nuclear), Jackson, SC (F, FA, I, P, T, V)  
 Basic E, Inc., Charlotte, VT (F, P, T, V)  
 BHI Energy - now Westinghouse, See listing for Westinghouse Electric Co., Cranberry Township, PA (F, P)  
 Consolidated Power Supply, (Div. of Consolidated Pipe & Supply Co., Inc.), Birmingham, AL (F, P)  
 ◆ Conval, Inc., Enfield, CT (F, P, T)

**View the 2024 Editorial Calendar & Rate Card**

How does your company plan to market themselves to the worldwide nuclear community in 2024 and beyond?

For more than 60 years that answer has remained the same—**Nuclear News** magazine and the affiliated print and digital publications offered by the American Nuclear Society.

[ans.org/advertising](https://ans.org/advertising)  
[advertising@ans.org](mailto:advertising@ans.org)  
 708-579-8226

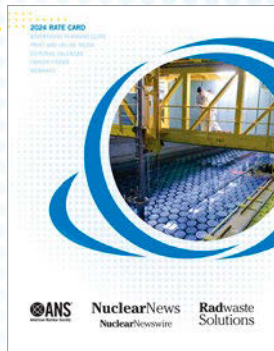

**Schutte & Koerting**

Serving the power industry since the early 1950's

**Throttle Trip Valves**  
3" - 24" to 2500# Class

**Non-Return Valves**  
4" - 30" to 1500# Class

- ASME Section VIII
- ANSI B16.34 & B16.5
- API Standards
- NEMA SM23/24

**Safety Related:**  
 Under a cooperative business agreement with **Sigma, Inc.**, Schutte & Koerting has reaffirmed our commitment to providing both commercial grade and safety related products to the nuclear industry.

Through Sigma's NUPIC audited dedication facility, Sigma performs required tests and inspections to ensure all critical characteristics are verified prior to shipment.

[www.s-k.com](http://www.s-k.com)

2510 Metropolitan Drive | Trevose, PA 19053 | United States | Tel. 215-639-0900 | sales@s-k.com

♦ Denotes advertiser—see Index to Advertisers on pages 8–14

### 91000 Valves, Gate

- B Bellows Seal  
 JA Jacketed Alloy  
 K Knife  
 PS Parallel Slide Type  
 W Wedge Type
- AECON-WACHS, (U.S. Div. of Aecon Nuclear), Jackson, SC (B, JA, K, PS, W)  
 Basic E, Inc., Charlotte, VT (K)  
 Consolidated Power Supply, (Div. of Consolidated Pipe & Supply Co., Inc.), Birmingham, AL (PS, W)  
 ♦ Conval, Inc., Enfield, CT (B, W)  
 ♦ Curtiss-Wright Nuclear Division, Brea, CA (B)  
 Curtiss-Wright Nuclear Division, QualTech NP, Cincinnati, OH (B)  
 ♦ Framatome Inc., (North American Headquarters), Lynchburg, VA (B, JA, K, PS, W)  
 GE Hitachi Nuclear Energy, Wilmington, NC (W)  
 IMI Critical Engineering, Burlington, Ontario, Canada (W)  
 KSB, Inc., Henrico, VA (B, K, PS, W)  
 ♦ Paragon Energy Solutions, (Paragon), Fort Worth, TX (B, K, PS, W)  
 ♦ The Park Company, Pasco, WA (PS, W)  
 ♦ Petersen Inc. (A Precinmac Company), Ogden, UT (JA, K, PS, W)  
 PK Valve & Engineering Co., Ltd., Changwon-si, Korea (The Republic of) (PS)  
 Trillium Flow Technologies, (Atwood & Morrill, Batley, Blakeborough, Hiller, Hopkinsons, Red Point, SARASIN-RSBD, SEBIM, Termomeccanica Pompe, Tricentric), Houston, TX (PS)  
 VAT Group, San Jose, CA (B, JA, K, PS, W)  
 Velan Inc., Montreal, Quebec, Canada (B, K, PS, W)  
 Westinghouse Electric Co. LLC, Cranberry Township, PA (W)  
 ♦ Westinghouse Electric Company LLC, (Westinghouse Parts Business), New Stanton, PA (B, JA, K, PS, W)

### 91260 Valves, Other

- BW Backwater  
 B Ball  
 BU Burner  
 BF Butterfly  
 D Diaphragm  
 EF Excess-Flow  
 FS Fail-Safe  
 FI Feedwater Isolation  
 FL Filter, In-Line  
 FD Fire Deluge  
 FM Flow Monitoring/Alarm System  
 FB Flush Bottom Tank  
 G Globe  
 GB Globe, Bellows  
 IM Instrumentation Manifold  
 IS Isolation Shutoff  
 LB Line-Blind  
 MS Main Steam Isolation  
 M Miniature  
 N Needle  
 P Packless  
 PL Plastic-Lined  
 PG Plug  
 PR Pressure Regulating  
 PU Pump Recirculation  
 Q Quick-Opening & -Closing  
 R Ram-Type  
 RS Relief, Safety  
 SL Slurry  
 SO Solenoid  
 TT Throttle Trip  
 V Vacuum
- ANKUG Engineering Co., Ltd., Seoul, Korea (The Republic of) (FD)  
 ASVAD INTL SL, Tarragona, Spain (FS, PR, Q, RS)  
 ♦ AVANTech, LLC, Columbia, SC (BW, B, BF, D, SO, V)  
 Basic E, Inc., Charlotte, VT (B, BF, D, FL, FD, G, GB, M, N, RS, SL, SO, TT)  
 BHI Energy - now Westinghouse, See listing for Westinghouse Electric Co., Cranberry Township, PA (BF, FL, G, MS, PG, RS)
- BNL Industries, Inc., Vernon Rockville, CT (B, EF, FS, Q, V)  
 C.J. Enterprises, (Div. of C.J. Instruments, Inc.), Tarzana, CA (PR)  
 Consolidated Power Supply, (Div. of Consolidated Pipe & Supply Co., Inc.), Birmingham, AL (B, BF, G, PG, PR, SO)  
 ♦ Conval, Inc., Enfield, CT (B, FI, FL, G, GB, IS, MS, N, P, PU, TT)  
 ♦ Curtiss-Wright Nuclear Division, Brea, CA (BF, D, EF, FS, FI, G, GB, IM, IS, MS, N, P, PG, PU, Q, RS, SL, SO, V)  
 Curtiss-Wright Nuclear Division, Eneritech, Brea, CA (BF, D, EF, FS, FI, G, GB, IM, IS, MS, N, P, PG, PU, Q, RS, SL, SO, V)  
 descote, Feyzin, France (FB, G, GB, N, RS)  
 Dragon Valves, Inc., Norwalk, CA (D, EF, G, GB, IM, M, N, P, PG, Q, SO)  
 ♦ Framatome Inc., (North American Headquarters), Lynchburg, VA (B, BF, FM, G, GB, MS, SO)  
 Glidewell Specialties Foundry Co., Calera, AL (B, BF, G)  
 IMI Critical Engineering, Burlington, Ontario, Canada (B, BF, G, GB, M)  
 K-Tek International Inc., Wilsonville, OR (B, EF, FI, GB)  
 KSB, Inc., Henrico, VA (B, BF, D, FS, FI, G, GB, IS, MS, M, N, P, PG, Q)  
 ♦ Mirion Technologies (IST) Corp., (Sensing Systems Div.), Horseheads, NY (D, Q, RS)  
 Mirion Technologies, Inc., (Sensing Systems Div.), Atlanta, GA (D, Q, RS)  
 Nuclear Energy Components Ltd, Hope Valley, Derbyshire, United Kingdom (RS)  
 NuSource LLC, Alexandria, VA (B, G, GB, IM, IS, M, N, PG, PR, RS, SO, TT)  
 ♦ Paragon Energy Solutions, (Paragon), Fort Worth, TX (B, BF, D, FI, G, GB, IM, IS, M, N, P, PG, PR, RS, SO)  
 ♦ The Park Company, Pasco, WA (B, BF, D, FI, G, MS, N, P, PG, RS, SO)  
 PK Valve & Engineering Co., Ltd., Changwon-si, Korea (The Republic of) (BF, G)  
 ♦ Preferred Engineering Corp., (Sub. of Preferred Utilities Mfg. Corp.), Danbury, CT (PG)  
 ♦ Schutte and Koerting, Trevose, PA (MS, PR, Q, RS, TT)  
 Technology for Energy Corp., Knoxville, TN (FM)  
 Trillium Flow Technologies, (Atwood & Morrill, Batley, Blakeborough, Hiller, Hopkinsons, Red Point, SARASIN-RSBD, SEBIM, Termomeccanica Pompe, Tricentric), Houston, TX (BF, FS, FI, G, IS, MS)  
 Tyne USA Inc., Jacksonville, FL (PR, V)  
 ♦ Valcor Engineering Corp., (Valcor Nuclear Div.), Springfield, NJ (EF, FS, FI, GB, IM, IS, M, N, P, PR, Q, SO, V)  
 VAT Group, San Jose, CA (BF, D, IS, V)  
 Velan Inc., Montreal, Quebec, Canada (B, BF, FI, G, GB, IS, MS, N, P, Q, SL, V)  
 Westinghouse Electric Co. LLC, Cranberry Township, PA (B, BF, FL, G, IM, MS, RS, SO)  
 ♦ Westinghouse Electric Company LLC, (Westinghouse Parts Business), New Stanton, PA (BW, B, BU, BF, D, EF, FS, FI, FL, FD, FM, FB, G, GB, IM, IS, LB, MS, M, N, P, PL, PG, PR, PU, Q, R, RS, SL, SO, TT, V)  
 WTM Valves and Services - Hammel Dahl, (Div. of Wright Technical Marketing), Lewisburg, PA (BF, G, GB, PR, PU)

### 91380 Valves, Pressure Seal

- BL Breech Lock  
 G Gate  
 GL Globe  
 PC Piston Check  
 SC Swing Check  
 TD Tilting Disk  
 W Wafer Check Valves
- AECON-WACHS, (U.S. Div. of Aecon Nuclear), Jackson, SC (BL, G, GL, PC, SC, TD, W)  
 Basic E, Inc., Charlotte, VT (G, GL, SC, W)  
 BNL Industries, Inc., Vernon Rockville, CT (W)  
 Consolidated Power Supply, (Div. of Consolidated Pipe & Supply Co., Inc.), Birmingham, AL (G, GL, PC, SC)  
 ♦ Conval, Inc., Enfield, CT (G, GL, PC)

If total life cycle cost is important to you, Conval® is the smartest choice for nuclear valves.



**Clampseal®  
Globe and  
Check Valves**



**Camseal®  
Metal-  
Seated  
Ball Valves**

Ask around and talk to peers! Thousands of high-performance Conval valves are operating in nuclear power plants around the world.

Available for EPC new construction or MRO applications. Specify the proven nuclear valve leader!

- ASME N/NPT, Appendix B and Part 21 compliant
- ISO & PED Certified

**Visit Conval.com today for details.**

Ask about our Certification, SEI-125, SEI-64, nuclear plant case studies and reference documents!



**Swividisc®  
Gate Valves**



**Bellows  
Seal Valves  
(high and low  
pressure)**

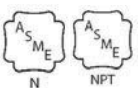

**Conval INC.**

World Headquarters  
 96 Phoenix Avenue  
 Enfield, CT 06082  
 860.749.0761 [Conval.com](http://Conval.com)



- ◆ Curtiss-Wright Nuclear Division, Brea, CA (G, GL, PC, SC, TD, W)  
Curtiss-Wright Nuclear Division, Enertech, Brea, CA (G, GL, PC, TD, W)  
Curtiss-Wright Nuclear Division, QualTech NP, Cincinnati, OH (G, GL, SC)
- ◆ Framatome Inc., (North American Headquarters), Lynchburg, VA (G, GL, PC)  
GE Hitachi Nuclear Energy, Wilmington, NC (G)  
Glidewell Specialties Foundry Co., Calera, AL (G, GL, SC)  
IMI Critical Engineering, Burlington, Ontario, Canada (PC)  
K-Tek International Inc., Wilsonville, OR (GL, W)  
KSB, Inc., Henrico, VA (G, GL, PC, SC, TD)  
NuSource LLC, Alexandria, VA (GL)
- ◆ Paragon Energy Solutions, (Paragon), Fort Worth, TX (G, GL, PC, SC, TD, W)
- ◆ The Park Company, Pasco, WA (G, GL, PC, SC, TD, W)

- ◆ Schutte and Koerting, Treose, PA (SC)  
Toshiba America Energy Systems Corp., West Allis, WI (G, GL, PC, SC, W)  
Trillium Flow Technologies, (Atwood & Morrill, Batley, Blakeborough, Hiller, Hopkinsons, Red Point, SARASIN-RSBD, SEBIM, Termomeccanica Pompe, Tricentric), Houston, TX (G, GL, SC, W)  
ValvTechnologies, Houston, TX (GL)  
VAT Group, San Jose, CA (BL, G)  
Velan Inc., Montreal, Quebec, Canada (G, GL, PC, SC, TD, W)  
Westinghouse Electric Co. LLC, Cranberry Township, PA (SC)
- ◆ Westinghouse Electric Company LLC, (Westinghouse Parts Business), New Stanton, PA (BL, G, GL, PC, SC, TD, W)

**92150 Venturis**

Baker Industries, a Lincoln Electric Company, Macomb, MI

- Glidewell Specialties Foundry Co., Calera, AL  
Joseph Oat Corp., Camden, NJ
- ◆ Major Tool & Machine, (A Precinmac Company), Indianapolis, IN  
NuSource LLC, Alexandria, VA
- ◆ Petersen Inc. (A Precinmac Company), Ogden, UT
- ◆ Schutte and Koerting, Treose, PA
- ◆ Valcor Engineering Corp., (Valcor Nuclear Div.), Springfield, NJ

**92300 Vessels**

- F Flasks, Water, Valve-Operating
- P Pressure
- PR Pressure, Reactor
- AECON-WACHS, (U.S. Div. of Aecon Nuclear), Jackson, SC (P)
- ◆ AeroFin, Lynchburg, VA (P)
- ◆ AVANTech, LLC, Columbia, SC (F, P)  
Baker Industries, a Lincoln Electric Company, Macomb, MI (P, PR)  
BWX Technologies, Inc., Lynchburg, VA (P, PR)  
Carolina Fabricators, West Columbia, SC (F, P, PR)  
Consolidated Power Supply, (Div. of Consolidated Pipe & Supply Co., Inc.), Birmingham, AL (P, PR)
- ◆ Curtiss-Wright Nuclear Division, Brea, CA (P)  
Curtiss-Wright Nuclear Division, QualTech NP, Cincinnati, OH (P)
- ◆ DuBose National Energy Services, Inc., Clinton, NC (P)  
Ellis & Watts Global Industries, Inc., (a sub. of Marmco, a Berkshire Hathaway company), Batavia, OH (P)  
Energyen Corporation, (Sales Operation), Gunsan, Korea (The Republic of) (F, P)
- ◆ Framatome Inc., (North American Headquarters), Lynchburg, VA (P, PR)  
Fuel Tank Maintenance Co., LLC, Cookeville, TN (P)  
GE Hitachi Nuclear Energy, Wilmington, NC (P, PR)  
Heatric Division of Meggitt (UK) Ltd., Poole, Dorset, United Kingdom (P)
- ◆ Holtec International, Camden, NJ (P)  
Hybrid Power Technologies LLC, Overland Park, KS (PR)  
IONEX Research Corp., Lafayette, CO (P)  
Joseph Oat Corp., Camden, NJ (P, PR)  
K-Tek International Inc., Wilsonville, OR (P)
- ◆ Major Tool & Machine, (A Precinmac Company), Indianapolis, IN (P, PR)  
NuSource LLC, Alexandria, VA (P, PR)
- ◆ Petersen Inc. (A Precinmac Company), Ogden, UT (P)  
Piping Technology & Products, Inc., Houston, TX (P)  
PMT Nuclear, Woodridge, IL (P)
- ◆ Precision Custom Components, LLC., (DC Fabricators), York, PA (F, P, PR)  
Premier Technology, Inc., Blackfoot, ID (PR)  
Sarens Nuclear & Industrial Services LLC, (Sarens), Houston, TX (PR)  
SKODA JS a.s., Plzen, Bolevec, Czech Republic (The) (P, PR)
- ◆ Super Radiator Coils, Chaska, MN (P)  
Teledyne Brown Engineering, Inc., Huntsville, AL (P)
- ◆ Thermal Engineering International (TEI), Cerritos, CA (P)  
TW Metals - Nuclear Materials Solutions, Linden, MI (P, PR)  
Tyne USA Inc., Jacksonville, FL (P, PR)
- ◆ Wagstaff Applied Technologies, Spokane, WA (F, P, PR)
- ◆ Westinghouse Electric Company LLC, (Westinghouse Parts Business), New Stanton, PA (F, P, PR)

**92800 Video Services**

- I Inspection
- PP Plant Photodocumentation
- R Remote
- U Underwater
- ◆ Ahlberg Cameras, Wilmington, NC (I, R, U)  
ASI Marine, (ASI Group Ltd.), Orchard Park, NY (I, U)

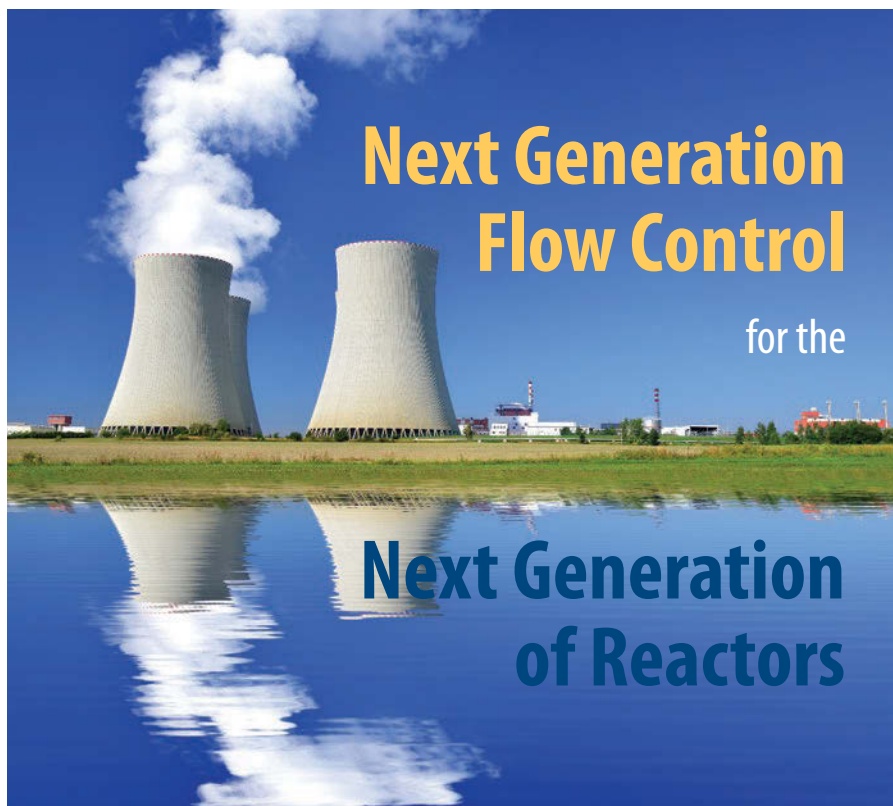

**Next Generation Flow Control**

for the

**Next Generation of Reactors**



- ▶ Constructed to meet the requirements of ASME Section III
- ▶ Products include safety and non-safety SOVs, PRVs, orifices, venturis and eductors
- ▶ Qualified to ASME QME-1, IEEE-323, 344, 382 and Reg Guide 1.180
- ▶ Supporting new builds and existing plants worldwide



Valcor Engineering Corporation

Contact us to learn how Valcor can help meet your specific flow control needs

www.valcor.com | (973)-467-8400 | nuclear@valcor.com

◆ Denotes advertiser—see Index to Advertisers on pages 8–14

ATS Industrial Automation, Inc. - Nuclear (UK), Blaby, Leicester, United Kingdom (I, R, U)  
 ATS Industrial Automation, Inc. Nuclear (Canada), Cambridge, Ontario, Canada (I, R, U)  
 BHI Energy - now Westinghouse, See listing for Westinghouse Electric Co., Cranberry Township, PA (I, R)  
 BWX Technologies, Inc., Lynchburg, VA (I, R, U)  
 ◆ Framatome Inc., (North American Headquarters), Lynchburg, VA (I, R, U)  
 James Fisher Technologies, Loveland, CO (I, R, U)  
 Lenox Instrument Co., Inc., Treveose, PA (R, U)  
 Master-Lee Engineered Products Inc., Latrobe, PA (I, R, U)  
 ◆ Mirion Technologies (IST) Corp., (Sensing Systems Div.), Horseheads, NY (R, U)  
 Mirion Technologies, Inc., (Sensing Systems Div.), Atlanta, GA (R, U)  
 Radium Inc., Waynesboro, VA (I, PP, R, U)  
 Sidus Solutions LLC, San Diego, CA (I, R, U)  
 ◆ Thermo Scientific - CIDTEC Cameras & Imagers, (Part of Thermo Fisher Scientific), Liverpool, NY (I, R, U)  
 ◆ Underwater Construction Corp., (Underwater Construction Corp. UK Ltd.), Essex, CT (R, U)  
 Westinghouse Electric Co. LLC, Cranberry Township, PA (I, R, U)

MD Mixed Waste Disposal/Treatment  
 MS Mixed Waste Solvent Disposal  
 MO Molten Salt Oxidizers  
 M Monitoring  
 NR Non-Radioactive  
 OF Off-Site (Fixed Base)  
 ON On-Site  
 P Packaging/Repackaging  
 LL Radioactive, Low-Level  
 HL Radioactive, High-Level  
 RD Resin Destruction  
 RP Resin Pyrolysis  
 RR Resin Regeneration  
 RC Resource Recovery  
 SM Scrap Melting  
 SS Sealed Source Decommissioning  
 S Solidification  
 SR Survey & Release  
 T Transuranic (TRU)  
 UT Uranium Mill Tailings Reclamation  
 V Vitrification  
 VR Volume Reduction  
 WC Waste Characterization  
 WS Waste Sampling  
 WD Wood Decontamination  
 Accelerated Decommissioning Partners - ADP, Dallas, TX (P, LL, HL)  
 Advanced Technologies and Laboratories (ATL) International, Inc., (wholly owned sub. of Planned Systems International, Inc.), Gaithersburg, MD (DL, ER, IL, LC, LW, M, LL, HL, SR, WC, WS)  
 Alaron Nuclear Services, (Veolia Nuclear Solutions Federal Services - Alaron), Wampum, PA (DL, IL, M, OF, P, HL, RC, SS, SR, VR, WC)  
 American DND Engineering, PC, Ellicottville, NY (ER, LC, SM, VR, WC)  
 ◆ American DND Inc., Grand Island, NY (DL, ER, FP, LC, NR, P, SM, VR)  
 ANTECH Corp., Arvada, CO (IL, M, LL, HL, SR, WC)

ARES Security Corp., Vienna, VA (M)  
 ATS Industrial Automation, Inc. - Nuclear (UK), Blaby, Leicester, United Kingdom (IL, MW, ON, LL, HL, RC, SM, S, VR)  
 ATS Industrial Automation, Inc. Nuclear (Canada), Cambridge, Ontario, Canada (IL, MW, ON, LL, RC, SM, S, VR)  
 ◆ AVANTech, LLC, Columbia, SC (DM, DW, DR, DL, ER, FP, LW, MW, MD, M, OF, LL, HL, RD, RP, RR, S, VR)  
 Babcock Services, Inc., Kennewick, WA (DW, DR, DL, ER, FP, IL, M, NR, OF, ON, P, LL, RC, SM, S, SR, VR, WC, WS, WD)  
 ◆ Banda Group International, LLC, Mesa, AZ (ER, MD, M, WC, WS)  
 BHI Energy - now Westinghouse, See listing for Westinghouse Electric Co., Cranberry Township, PA (ER, FP, MW, M, ON, P, LL, RC, SR, T, VR, WC, WD)  
 Bilfinger Noell GmbH, (Dept. BEV), Wuerzburg, Germany (DL, IL, MD, P, LL, HL, S, VR)  
 Burns & McDonnell, Kansas City, MO (ER, M, NR, ON, LL, SR)  
 BWX Technologies, Inc., Lynchburg, VA (ER, MW, MD, P, LL, HL, T, WC)  
 Cabrera Services Inc., East Hartford, CT (DL, ER, MW, MD, M, OF, ON, P, LL, HL, SR, T, V, WC)  
 Campoverde srl, Milano, Italy (DL, ER, I, IL, LW, MW, LL, HL, RD, V, VR, WC)  
 Central Research Laboratories, Red Wing, MN (P)  
 Chesapeake Nuclear Services, Inc., Annapolis, MD (SR, WC)  
 Croft Associates Ltd, Abingdon, Oxfordshire, United Kingdom (DL, IL, LW, P, LL, HL)  
 CS-2 Inc., Grand Island, NY (DL, NR, SM, WC)  
 Curie Environmental Services, Albuquerque, NM (DL, LC, MW, MD, MS, NR, OF, ON, P, LL, RC, SS, SR, WC, WS)  
 ◆ Curtiss-Wright EST Group, Hatfield, PA (WS)  
 Deep Isolation, Inc., Berkeley, CA (IL, MD, OF, ON, P, HL, T)

93040 Waste Management Services

DM Demineralization  
 DW Dewatering, Nonradioactive  
 DR Dewatering, Radioactive  
 DL Disposal (Low-Level)  
 ER Environmental Remediation  
 FP Fuel Pool Services  
 I Incineration  
 IL Intermediate-Level  
 LC Lead Contamination  
 LW Liquid Waste (High Level & Low Level)  
 MW Mixed Waste Analysis & Processing

# NuclearNews

## July-December 2024 Editorial Calendar & Advertising Planning Guide

### JULY

#### Fusion | President's Profile

The latest developments in fusion energy and applications, and the annual profile of the incoming ANS president.

**AD SPACE** June 3 **MATERIAL DUE** June 5

- 26th Technology of Fusion Energy (TOFE 2024)
- Health Physics Society Annual Meeting

### AUGUST

#### Supplier Showcase | Policy

The 30th annual vendor/contractor issue, featuring BOGO ad space to profile your company, along with a look at policy making that affects the nuclear community ahead of the 2024 election season.

**AD SPACE** June 28 **MATERIAL DUE** July 2

- Utility Working Conference and Vendor Technology Expo (UWC 2024)

### SEPTEMBER

#### Education and Workforce (Back to School)

From university nuclear engineering programs, to K-12 education, professional development, and more, education is the future.

**AD SPACE** Aug 2 **MATERIAL DUE** Aug 5

- Plutonium Futures - The Science 2024

### OCTOBER

#### Outage Management | Plant Maintenance

Coverage of a perennially relevant topic, coinciding with the fall outage season.

**AD SPACE** Sept 3 **MATERIAL DUE** Sept 5

- Pacific Basin Nuclear Conference 2024 (PBNC)

### NOVEMBER

#### Waste Management

Articles on the safe and secure treatment, storage, and disposal of solid and liquid wastes from nuclear operations.

**AD SPACE** Oct 3 **MATERIAL DUE** Oct 7

- ANS Winter Conference and Expo

### DECEMBER

#### 40 under 40

A look at the top young scientists, engineers, plant workers, government officials, suppliers, and others who make up the nuclear community.

**AD SPACE** Nov 1 **MATERIAL DUE** Nov 4

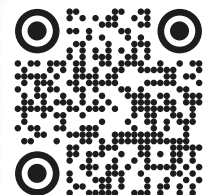



**Banda Group  
International**

**NAICS**

213112, 236210, 236220, 237120, 237130,  
562910, 541330, 541611, 541620, 541690,  
541990, 561110, 561210, 561612, 561621

**Certifications**

SBE | MBE | SDB | SDVOSB

**UEI**

GJQFDZ6LD4P3

**Cage Code**

4JTH3

**Health, Safety &  
Quality Assurance**

**Environmental, Characterization,  
Remediation, Waste Management  
and D&D**

**Nuclear Explosives Safety**

**Security & Safeguards**

**Construction Management  
& Site Support**



James Lockhart, PE  
VP of Government Operations  
jamesl@bandagroupintl.com  
480.848.7002

Toshal Patel  
Senior Proposal Manager  
toshal.patel@bandagroupintl.com  
505.308.8630



◆ Denotes advertiser—see Index to Advertisers on pages 8–14

◆ **Dominion Engineering, Inc., Reston, VA (DM, DR, FP, IL, LW, MW, MD, VR, WS)**

See advertisement on page 49

DW James Consulting, LLC, North Oaks, MN (FP, M, P, LL, VR, WC, WS)  
ECC, Burlingame, CA (ER, M, NR, ON, P, LL, HL, S, SR, UT, WC)

◆ **Element Nuclear (NTS Labs), (Nuclear Engineering & Test Services), Huntsville, AL (M)**

Encorus Group, Springville, NY (ER, FP)  
Energy, Technology and Environmental Business Association, (ETEBA), Oak Ridge, TN (ER, WC)

◆ **EnergySolutions, Salt Lake City, UT (DM, DW, DR, DL, ER, FP, I, IL, LC, MW, MD, MS, M, NR, OF, ON, P, LL, HL, RC, SM, SS, S, SR, T, UT, V, VR, WC, WD)**

See advertisement on page 11

Environmental Restoration Group, Inc., Albuquerque, NM (UT)  
Equipos Nucleares, S.A., S.M.E, Maliaño (Cantabria), Spain (HL)  
Fuel Tank Maintenance Co., LLC, Cookeville, TN (DM, DW, ER, LC, NR)  
GEL Laboratories, LLC, (A Member of The GEL Group, Inc.), Charleston, SC (WC)  
GEM Technologies, Inc., Knoxville, TN (DM, DW, DR, DL, ER, LC, MD, M, P, LL, HL, T, WC, WS)

GNS Gesellschaft fur Nuklear-Service mbH, Essen, Germany (IL, OF, ON, LL, HL, WC)  
GSE Engineering, Systems & Simulation, (GSE Systems), Columbia, MD (MW, M)

◆ **Holtec International, Camden, NJ (DL, ER, FP, ON, P, VR)**

◆ **I.C.E. Service Group, Inc., Moon Township, PA (DL, ER, I, IL, LC, MW, MD, MS, NR, OF, ON, P, LL, HL, S, T, UT, VR, WC, WS, WD)**  
ISO-PACIFIC Remediation Technologies, Inc., Richland, WA (DR, DL)

Jacobs, (CH2M HILL Nuclear Business Group), (CH2M HILL International Nuclear Services, Ltd.), (CH2M HILL Constructors, Inc.), (Jacobs Engineering), (Jacobs), Dallas, TX (DL, ER, FP)  
James Fisher Technologies, Loveland, CO (FP, MW)

Kinectrics Inc., Toronto, Ontario, Canada (ER, IL, MW, MD, M, NR, OF, ON, P, LL, HL, WC, WS)

Komline, Peapack, NJ (DW, DR)  
KUKA Systems UK Ltd, Halesowen, West Midlands, United Kingdom (MW, P, LL, VR, WC)

◆ **LND, Inc., Oceanside, NY (DR, DL, IL, MW, M, HL, UT, WC)**

Longenecker & Associates, Inc., Las Vegas, NV (ER)  
Lucideon, Schenectady, NY (LL, S)  
Merrick & Company, Greenwood Village, CO (DM, DW, DR, MW, MD, P, LL, HL, T)  
Mirion Technologies (Canberra) Inc., Meriden, CT (HL)

◆ **Mirion Technologies (IST) Corp., (Sensing Systems Div.), Horseheads, NY (M)**  
Mirion Technologies (MGPi H&B) GmbH, (Mirion Technologies), Munich, Germany (M)  
Mirion Technologies, Inc., (Sensing Systems Div.), Atlanta, GA (M)

◆ **NAC International Inc., Peachtree Corners, GA (ON, LL, HL)**  
NAC Philotechnics, Ltd., Oak Ridge, TN (DR, DL, ER, I, MD, OF, ON, P, LL, HL, SS, S, SR, VR, WC)

Navarro, Oak Ridge, TN (DL, ER, MW, MD, P, LL, HL, T, WC)  
Neptune and Company, Inc., Lakewood, CO (M, NR, LL, HL, T)

New Millennium Nuclear Technologies International, Lakewood, CO (ER, WC, WS)  
NFT, (by Alpha Safety Group), Golden, CO (MW, P, LL, HL, T, WC)  
North Wind Group, Idaho Falls, ID (ER)

NSSI/Recovery Services Inc., Houston, TX (DL, I, IL, LC, MW, MD, MS, M, NR, OF, ON, P, LL, HL, RC, SS, S, SR, T, V, VR, WC, WD)

Orano Decommissioning Services, Hudson, MA (P, LL, HL)  
Orano TN, Columbia, MD (FP, OF, ON, P, LL, HL)

Orano USA, Bethesda, MD (DR, ER, FP, LW, MW, MD, MS, P, LL, HL, RC, SS, S, V, VR, WC, WS)

Pajarito Scientific Corp., Santa Fe, NM (ER, IL, MW, M, LL, HL, SR, T, WC)

PAR Systems, LLC, Saint Paul, MN (P, VR)  
Perma-Fix Environmental Services, Inc., Oak Ridge, TN (DL, ER, I, IL, LC, LW, MW, MD, MS, M, OF, ON, P, LL, HL, RD, S, SR, T, VR, WC, WS)  
PHDS Co., Knoxville, TN (LL)

Premier Technology, Inc., Blackfoot, ID (P, LL, HL, T, VR)  
PTP Spent Fuel Services, LLC, Grand Island, NY (FP, LL, HL)

Radiation Pros, LLC, (dba Rad Pros), Englewood, CO (DW, DR, DL, ER, MW, MD, NR, ON, P, LL, HL, SS, SR, UT, VR, WC, WS)  
Radiation Protection Systems, (by Alpha Safety), Groton, CT (HL, VR)

◆ **Radiation Safety & Control Services, Inc., Seabrook, NH (MW, ON, LL, HL, VR, WC)**  
Radiological Solutions Inc., Rockdale, IL (RR, WS)

◆ **Reef Industries, Inc., (Griffolyn, Div. of Reef Industries, Inc.), Houston, TX (LL)**  
ReNuke, Oak Ridge, TN (ON, P, LL)  
Republic Services, Livonia, MI (DL, LL)  
Robatel Technologies, LLC, Roanoke, VA (P)  
Rousselet-Robatel, Pittsfield, MA (DW, DR, LW)  
S&G Enterprises, Inc., Germantown, WI (VR)  
S&K Logistics Services, Byron, GA (ER, M, NR, LL)

J. L. Shepherd & Assoc., San Fernando, CA (SS)  
Sidus Solutions LLC, San Diego, CA (M)  
Siempelkamp NIS, Alzenau, Germany (MW, MD, P, VR, WC)

20th Annual Buyers Guide

# Radwaste Solutions

FALL 2024

The annual **Radwaste Solutions Products, Materials, and Services Directory** lists nearly 500 worldwide companies that supply 173 products or services related to the generation, handling, treatment, cleanup, transportation, storage, and disposal of radioactive waste.

**AD SPACE** August 9      **MATERIAL DUE** August 13

Plan ahead, reserve your ad space today!  
[ans.org/advertising](https://ans.org/advertising) | [advertising@ans.org](mailto:advertising@ans.org)

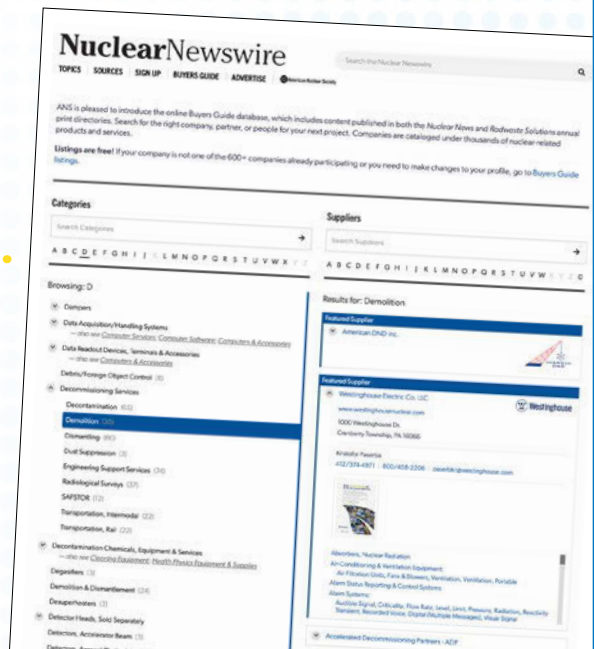

## Become a Featured Supplier!

While there is no charge for a company listing, only advertisers receive several print listing enhancements and online upgrades including: company logo, Featured Supplier designation and listing boosted to top of category search results!

- Sigma Science, Inc., Albuquerque, NM (MW, P, LL, HL, WC)
- Southwest Research Institute, San Antonio, TX (SS, WC, WS)
- ♦Strategic Packaging Systems, (I.C.E. Packaging Company, LLC), Madisonville, TN (DL, ER, I, IL, LC, MW, MD, MS, NR, OF, ON, P, LL, HL, S, T, UT, VR, WC, WS, WD)
- Technical Associates, (a Div. of US Nuclear Corp.), Canoga Park, CA (M, LL, HL)
- Teledyne Brown Engineering, Inc., Huntsville, AL (WC)
- TerranearPMC, LLC, Exton, PA (ER, LC, MW, MD, MS, P, LL, HL, WC)
- Tetra Tech Inc., Richland, WA (ER, MW, P)
- The Delphi Groupe, Inc., Austin, TX (I, IL, M, NR, ON, P, HL, S, VR)
- TMMC (Toxco Materials Management Center), Oak Ridge, TN (DR, DL, LC, OF, P, LL, RC, S, SR, VR, WC, WS)
- Transco Products Inc., Streator, IL (M)
- TransWare Enterprises Inc., St. Louis, MO (WC)
- ♦Underwater Construction Corp., (Underwater Construction Corp. UK Ltd.), Essex, CT (FP)
- UniTech Services Group Europe, (Sub. of UniTech Services Group USA), Coevorden, Netherlands (The) (VR)
- ♦UniTech Services Group, Inc., (Div. of UniFirst Corp.), Longmeadow, MA (DL, LC, VR, WD)
- University of Bristol, (Interface Analysis Centre) (South West Nuclear Hub), Bristol, United Kingdom (ER, WC)
- Veolia Nuclear Solutions - Federal Services, Piketon, OH (V)
- Warrington, Inc., Pflugerville, TX (LC)
- Waste Control Specialists LLC, Andrews, TX (DR, DL, ER, LC, MW, MD, MS, NR, OF, ON, P, LL, SS, S, T, UT, VR, WC, WS)
- Westinghouse Electric Co. LLC, Cranberry Township, PA (DM, DW, DR, DL, ER, FP, IL, MW, MD, MS, M, NR, OF, ON, P, LL, HL, RD, RP, RR, RC, SM, SS, S, SR, T, UT, VR, WC, WD)
- ♦WMG, Inc., Peekskill, NY (FP, IL, OF, ON, P, LL, HL, S, T, WC)

See advertisement on page 5

**93220 Water Intake Facilities**

- FG Fish Guiding Systems
- ST Screens, Traveling
- TR Trash Racks
- ASI Marine, (ASI Group Ltd.), Orchard Park, NY (ST, TR)
- Beaudrey American Services, Loveland, CO (FG, ST, TR)
- ♦Curtiss-Wright Nuclear Division, Brea, CA (ST)
- Curtiss-Wright Nuclear Division, QualTech NP, Cincinnati, OH (ST)
- ♦Framatome Inc., (North American Headquarters), Lynchburg, VA (ST)
- Intralox, New Orleans, LA (ST)
- Kinectrics Inc., Toronto, Ontario, Canada (FG)
- ♦Paragon Energy Solutions, (Paragon), Fort Worth, TX (ST)
- ♦Petersen Inc. (A Precinmac Company), Ogden, UT (TR)
- ♦Underwater Construction Corp., (Underwater Construction Corp. UK Ltd.), Essex, CT (ST, TR)

**93240 Water Quality Management Services**

- DW James Consulting, LLC, North Oaks, MN
- ♦Framatome Inc., (North American Headquarters), Lynchburg, VA
- ♦I.C.E. Service Group, Inc., Moon Township, PA
- Kinectrics Inc., Toronto, Ontario, Canada
- ♦NUCON International, Inc., Columbus, OH
- Toshiba America Energy Systems Corp., West Allis, WI

**93500 Water Treatment Equipment & Supplies**

- C Chlorination
- CP Condensate Polishing
- DM Demineralization
- DO Deoxygenation
- P Portable Systems
- RO Reverse Osmosis, Mobile

- SH Sodium Hypochlorite Generators
- S Softening/Clarification
- ♦AVANTech, LLC, Columbia, SC (C, CP, DM, DO, P, RO, S)
- Dufrane Nuclear Shielding Inc., (Dufrane Nuclear Inc.), Winsted, CT (P)
- ♦EnergySolutions, Salt Lake City, UT (DM, P, RO)
- ♦Framatome Inc., (North American Headquarters), Lynchburg, VA (DM, P)
- Fuel Tank Maintenance Co., LLC, Cookeville, TN (P, RO)
- GE Hitachi Nuclear Energy, Wilmington, NC (CP, DM, S)
- Joseph Oat Corp., Camden, NJ (DM)
- ♦NUCON International, Inc., Columbus, OH (CP)
- Tri Nuclear Corp., Troy, NY (DM, P)
- Westinghouse Electric Co. LLC, Cranberry Township, PA (C, CP, DM, DO, P, RO, S)

**93750 Weld Surfacing**

- EA Electric Arc
- HA Helium Arc
- MI Metal/Inert Gas
- PS Plasma Spray
- PT Plasma Transferred Arc
- SA Submerged Arc
- TI Tungsten/Inert Gas
- AECON-WACHS, (U.S. Div. of Aecon Nuclear), Jackson, SC (EA, HA, MI, PS, PT, SA, TI)
- Aptim, Baton Rouge, LA (EA, MI, TI)
- Carolina Fabricators, West Columbia, SC (EA, MI, PT, SA, TI)
- E.S. Fox Limited, Niagara Falls, Ontario, Canada (EA, HA, MI, TI)
- Electrical Builders Inc. (EBI), St. Cloud, MN (MI, TI)
- ♦Framatome Inc., (North American Headquarters), Lynchburg, VA (HA, TI)
- GE Hitachi Nuclear Energy, Wilmington, NC (SA)
- Magnatech LLC, East Granby, CT (MI, TI)
- Nuclear Energy Components Ltd, Hope Valley, Derbyshire, United Kingdom (EA, MI, TI)
- ♦Precision Custom Components, LLC., (DC Fabricators), York, PA (EA, HA, MI, PS, SA, TI)
- Schulz Electric, Timken Power Systems, East Haven, CT (EA, MI)
- Toshiba America Energy Systems Corp., West Allis, WI (EA, HA, MI)
- ♦Underwater Construction Corp., (Underwater Construction Corp. UK Ltd.), Essex, CT (EA, MI)

**93800 Welding Equipment**

- AS Antispatter Compound
- A Arc
- AR Arc, Robotic
- AT Automatic Tube & Pipe
- BR Backup Rings
- B Blankets, Protective Screens, Etc.
- CR Contraction Rings (for Socket Welds)
- EF Electrodes, Filler Materials
- EU Electrodes, Underwater
- EB Electron Beam
- IR Insert Rings, Consumable
- LB Laser Beam
- O Orbital
- OT Orbital TIG Narrow-Gap
- PF Pipe Fit-up Tools
- P Plasma
- PS Power Supplies & Controls
- PR Programmers
- RM Remote
- R Resistance
- S Stud
- TT Tube-Tubesheet
- WC Waste Container Lid Welders
- WR Welding Rings
- WW Welding Wire
- WH Welding Wire, High-Purity
- AECON-WACHS, (U.S. Div. of Aecon Nuclear), Jackson, SC (A, AR, AT, BR, B, O, OT, PF, P, PS, PR, RM, R, S, TT, WC, WR, WW, WH)
- Aptim, Baton Rouge, LA (A, RM)
- Aquasol Corp., North Tonawanda, NY (CR, IR, PF, WR)
- Baker Industries, a Lincoln Electric Company, Macomb, MI (A, AR, AT, B, EF, EU, EB, P, PS, PR, R, WW, WH)

- BHI Energy - now Westinghouse, See listing for Westinghouse Electric Co., Cranberry Township, PA (PS)
- BWX Technologies, Inc., Lynchburg, VA (AR, LB, RM, TT, WC)
- Consolidated Power Supply, (Div. of Consolidated Pipe & Supply Co., Inc.), Birmingham, AL (EF, EU, S)
- ♦Curtiss-Wright Nuclear Division, Brea, CA (B)
- Curtiss-Wright Nuclear Division, AP Services, Middleburg Heights, OH (B)
- ♦DuBose National Energy Services, Inc., Clinton, NC (BR, EF, IR, S, WR, WW)
- E.H. Wachs, (A Div. of ITW), Lincolnshire, IL (AT, O, OT, PF, TT)
- ♦Framatome Inc., (North American Headquarters), Lynchburg, VA (A, AR, B, EU, RM, TT)
- FuseRing Inc., London, Ontario, Canada (WC, WR)
- KUKA Systems UK Ltd, Halesowen, West Midlands, United Kingdom (AR)
- Magnatech LLC, East Granby, CT (A, AT, OT, PS, PR, RM)
- MarShield Radiation Shielding, (Div. of Marswell Metal Industries Ltd.), Burlington, Ontario, Canada (B)
- NuVision-HWM, (Wälischmiller Engineering), Pittsburgh, PA (AR)
- PAR Systems, LLC, Saint Paul, MN (AR)
- PROTEM USA LLC, Evergreen, CO (O, OT)
- Rich Industries Inc., New Philadelphia, OH (B)
- Tioga Pipe, Philadelphia, PA (EF, IR, WW)
- TW Metals - Nuclear Materials Solutions, Linden, MI (EF, IR, WW, WH)
- Weldstar, Aurora, IL (AS, EF, IR, WW)
- Westinghouse Electric Co. LLC, Cranberry Township, PA (PS)

**93900 Welding Services**

- A Arc
- AT Automatic Tube & Pipe
- C Canister
- DB Diffusion Bonding
- EM Electromagnetic
- EB Electron Beam
- EX Explosive
- LB Laser Beam
- P Plasma
- RM Remote
- S Stud
- UM Underwater, Manual
- UR Underwater, Remote
- WO Weld Overlays
- WC Weldment Cleaning
- Advanced Consulting Group, Inc., Chicago, IL (P)
- AECON-WACHS, (U.S. Div. of Aecon Nuclear), Jackson, SC (A, AT, DB, EM, P, RM, S, WO, WC)
- Alaron Nuclear Services, (Veolia Nuclear Solutions Federal Services - Alaron), Wampum, PA (A)
- Aptim, Baton Rouge, LA (A, AT, RM, WO)
- ASI Marine, (ASI Group Ltd.), Orchard Park, NY (UM, UR)
- ♦AVANTech, LLC, Columbia, SC (A, AT, C, UM)
- Baker Industries, a Lincoln Electric Company, Macomb, MI (A, EM, EB, LB, P)
- BHI Energy - now Westinghouse, See listing for Westinghouse Electric Co., Cranberry Township, PA (A, RM, WO)
- Carolina Fabricators, West Columbia, SC (A, AT, P, S)
- ♦DuBose National Energy Services, Inc., Clinton, NC (A, AT, C, S, WO, WC)
- E.S. Fox Limited, Niagara Falls, Ontario, Canada (A, AT)
- Electrical Builders Inc. (EBI), St. Cloud, MN (A, P)
- Energy Steel, Rochester Hills, MI (A, P, S)
- EPD, Carlsbad, NM (A, P)
- ♦Framatome Inc., (North American Headquarters), Lynchburg, VA (A, AT, EM, EB, EX, LB, P, RM, S, UR, WO, WC)
- Fuel Tank Maintenance Co., LLC, Cookeville, TN (A, AT, C, DB, EM, EB, EX, P, S, WO, WC)
- FuseRing Inc., London, Ontario, Canada (C)
- GE Hitachi Nuclear Energy, Wilmington, NC (A, AT, RM, UR, WO, WC)



◆ Denotes advertiser—see Index to Advertisers on pages 8–14

Heatric Division of Meggitt (UK) Ltd., Poole, Dorset, United Kingdom (DB)  
 In-Place Machining Company, LLC, Blue Ash, OH (RM)  
 Joseph Oat Corp., Camden, NJ (C)  
 Magnatech LLC, East Granby, CT (AT)  
 ◆ Major Tool & Machine, (A Precinmac Company), Indianapolis, IN (A, LB, P)  
 PAR Systems, LLC, Saint Paul, MN (RM)  
 PAVETECH Co., Ltd., Hwaseong-si, Korea (The Republic of) (AT)  
 PMT Nuclear, Woodridge, IL (A, AT, LB, S, WO)  
 ◆ Precision Custom Components, LLC., (DC Fabricators), York, PA (A, P, RM, S, WO)  
 Premier Technology, Inc., Blackfoot, ID (A, AT, C, S, WO)  
 PROTEM USA LLC, Evergreen, CO (A, AT, RM, S, UR)  
 Schulz Electric, Timken Power Systems, East Haven, CT (A)  
 SKODA JS a.s., Plzen, Bolevec, Czech Republic (The) (A, EM, EB, LB, P)  
 ◆ Underwater Construction Corp., (Underwater Construction Corp. UK Ltd.), Essex, CT (A, P, RM, UM, UR)  
 ◆ Wagstaff Applied Technologies, Spokane, WA (A, AT, S, WO, WC)  
 Westinghouse Electric Co. LLC, Cranberry Township, PA (A, AT, P, RM, S, UM, UR, WO)

### 95300 Well-Logging Equipment

◆ LND, Inc., Oceanside, NY  
 Mirion Technologies, Inc., (Sensing Systems Div.), Atlanta, GA  
 NSSI/Recovery Services Inc., Houston, TX

### 95750 Windows, Radiation-Shielding

LG Lead Glass  
 LP Lead Plastics  
 Bilfinger Noell GmbH, (Dept. BEV), Wuerzburg, Germany (LG)  
 Dufrane Nuclear Shielding Inc., (Dufrane Nuclear Inc.), Winsted, CT (LG, LP)  
 Hot Cell Services Corp., (HCS Corp.), Kent, WA (LG)  
 JSM Protective, Inc., Port St. Lucie, FL (LG, LP)  
 MarShield Radiation Shielding, (Div. of Marswell Metal Industries Ltd.), Burlington, Ontario, Canada (LG, LP)  
 Merrick & Company, Greenwood Village, CO (LG, LP)  
 Premier Technology, Inc., Blackfoot, ID (LG)

### 95850 Wipers, Wiping Cloths

C Cotton  
 CR Clean Room Laundered

D Disposable, Soluble  
 I Industrial  
 LF Lint-Free  
 OT Oil-Treated Dusting  
 T Tacky  
 ◆ Alphasource, Inc., Philadelphia, PA (C, CR, D, I, LF, OT, T)  
 Aquasol Corp., North Tonawanda, NY (D, I)  
 Coastal Network, Inc, Charlottesville, VA (C, OT, T)  
 Eastern Technologies, Inc., (OREX; PolyZolv), Ashford, AL (C, D, I, LF, OT, T)  
 ◆ Frham Safety Products, Inc., Rock Hill, SC (C, D, I, LF)  
 JSM Protective, Inc., Port St. Lucie, FL (C, CR, D, I, LF, OT, T)  
 Mohawk Safety, Inc., Manchester, CT (C, I, LF, OT, T)  
 UniTech Services Group Europe, (Sub. of UniTech Services Group USA), Coevorden, Netherlands (The) (C, CR, D, I, LF, OT, T)  
 ◆ UniTech Services Group, Inc., (Div. of UniFirst Corp.), Longmeadow, MA (C, CR, D, I, LF, T)

### 95900 Wire

CG Commercial Grade Dedication  
 IO Insulated, Oxide  
 IS Insulated, Signal  
 SW Insulated, Switchboard  
 IT Insulated, Thermocouple  
 M Magnet  
 MH Magnet, High-Temperature  
 MS Metal-Shielded  
 NM Nickel, Monel & Nickel-Chromium  
 RF Refractory  
 RS Resistance  
 SP Spring  
 SU Superconducting  
 T Thermocouple  
 Basic E, Inc., Charlotte, VT (IS, SW)  
 C.J. Enterprises, (Div. of C.J. Instruments, Inc.), Tarzana, CA (IO, M, MH)  
 CableLAN Nuclear, Fort Myers, FL (IS, SW, IT, MS)  
 Centronic Ltd., Surrey, United Kingdom (IT, MH, MS, T)  
 Cross Manufacturing Co. (1938) Ltd., Bath, United Kingdom (NM, SP)  
 ◆ Curtiss-Wright Nuclear Division, Brea, CA (IS, SW, IT)  
 Curtiss-Wright Nuclear Division, QualTech NP, Cincinnati, OH (IS, SW, IT)  
 ◆ Mirion Technologies (IST) Corp., (Sensing Systems Div.), Horseheads, NY (MS, T)  
 Mirion Technologies, Inc., (Sensing Systems Div.), Atlanta, GA (MS, SU, T)

Schulz Electric, Timken Power Systems, East Haven, CT (M)  
 THERMOCOAX Inc., Alpharetta, GA (IS, IT, MS, NM, T)  
 THERMOCOAX SAS, Caligny, France (IS, IT, MS, NM, T)  
 ◆ Westinghouse Electric Company LLC, (Westinghouse Parts Business), New Stanton, PA (IO, IS, SW, IT, M, MH, MS, NM, RF, RS, SP, SU, T)

### 96200 Work Platforms

C Cask Servicing  
 M Mobile  
 S Stationary  
 AECON-WACHS, (U.S. Div. of Aecon Nuclear), Jackson, SC (C)  
 Baker Industries, a Lincoln Electric Company, Macomb, MI (C, M, S)  
 Carolina Fabricators, West Columbia, SC (C, S)  
 Consolidated Power Supply, (Div. of Consolidated Pipe & Supply Co., Inc.), Birmingham, AL (M, S)  
 ◆ Curtiss-Wright Nuclear Division, Brea, CA (C)  
 Curtiss-Wright Nuclear Division, Sciencetech, Idaho Falls, ID (C)  
 ◆ DuBose National Energy Services, Inc., Clinton, NC (C, M, S)  
 Dufrane Nuclear Shielding Inc., (Dufrane Nuclear Inc.), Winsted, CT (C, M, S)  
 ◆ Framatome Inc., (North American Headquarters), Lynchburg, VA (M, S)  
 GE Hitachi Nuclear Energy, Wilmington, NC (S)  
 Konecranes Nuclear Equipment & Services LLC, (Formerly Morris Material Handling / P&H), New Berlin, WI (S)  
 ◆ Petersen Inc. (A Precinmac Company), Ogden, UT (C, M, S)  
 Robatel Technologies, LLC, Roanoke, VA (C)

### 96300 Workbenches, Maintenance, Portable

◆ Preferred Engineering Corp., (Sub. of Preferred Utilities Mfg. Corp.), Danbury, CT

### 96500 Wrenches, Hydraulic Ratchet

Integra Services Technologies Inc., Sarnia, Ontario, Canada

### 96700 X-ray Diffraction Apparatus

Rexon Components, Inc., Beachwood, OH

# PREFERRED ENGINEERING

FORMED IN 1980, PREFERRED ENGINEERING DESIGNS AND MANUFACTURES INNOVATIVE NUCLEAR SPECIALTY EQUIPMENT.

CUSTOM ENGINEERING SOLUTIONS

LIFTING DEVICES

PLUGS, COVERS, SEALS

PLANT SAFETY EQUIPMENT



# ANS<sup>®</sup> ORGANIZATION MEMBERS

ANS Organization Members play a vital role in our mission to advance, foster, and spur the development and application of nuclear science, engineering, and technology to benefit society. Join our continually expanding roster of nuclear industry leaders at [www.ans.org/orgmembers](http://www.ans.org/orgmembers).



Alaron Nuclear  
 American Assoc. of Physicists in Medicine  
 American Electric Power  
 Barnhart Nuclear Services  
 Capitol Associates  
 Carolina Fabricators, Inc.  
 Champion Specialty Services  
 Criticality Thinking Nuclear Consulting  
 Deltech Kiln and Furnace Design, LLC  
 Dragons De Veracruz  
 Energy Public Labs

Gamma Industry Processing Alliance  
 Generation Atomic  
 Health Physics Society/ Nuclear Sector Coordinating Council  
 HULSEY PC  
 King Abdullah City for Atomic and Renewable Energy  
 Los Alamos National Laboratory  
 Mega-Tech Services, LLC  
 Metoree  
 Nordion  
 NRSL, National Atomic Research Institute

Nuclear Electric Insurance Limited  
 Nuclear  
 Nuclear Safety Commission Radiation Monitoring Center  
 NuScale Power  
 Oak Ridge National Laboratory  
 OTEK Corporation  
 Radiation Safety & Control Services, Inc.  
 RdF Corporation  
 Reef Industries, Inc.  
 Silver Fir Software, Inc.  
 SpectronRX

SRS Community Reuse Organization  
 Technologie Inovaweld Inc.  
 TerraPraxis Inc  
 Terrestrial Energy Inc.  
 TN Tech University  
 Tokamak Energy Ltd  
 Transco Products Inc.  
 U.S. Department of Energy - Idaho Operations Office  
 University of Oklahoma, Institute for Public Policy Research and Analysis  
 WM Symposia, Inc.



This section lists in alphabetical order the companies represented in Section I of the Buyers Guide, “Nuclear Products, Materials & Services Directory.” Each listing includes the supplier’s location, sales contact (name), telephone numbers, N Stamp information, and code numbers corresponding to the categories under which each company is listed. When provided by the company, email and/or website addresses are also included. An asterisk (\*) appearing at the end of the listing indicates that a full-line product, materials, and/or services catalog is available from the supplier. Those suppliers who have an advertisement in *Nuclear News* Buyers Guide 2024 are highlighted in yellow. The “Directory of Suppliers” is divided into two parts: Part 1 lists companies located in the United States; Part 2, companies in other countries (page 155).

### 3 Bears Technical Services

Hixson, TN | [www.3bearstechnicalservices.com](http://www.3bearstechnicalservices.com)  
Richard Creed | 312/833-8334 | [rcreed@3bears.me](mailto:rcreed@3bears.me)  
**Codes:** 09800

### 3G Services Company LLC

Clinton, MS  
Gregg W. Ludlam | 610/247-9819 | [3gservicesco@gmail.com](mailto:3gservicesco@gmail.com)  
**Codes:** 14000, 86300, 86400

### 3M Technical Ceramics, Inc.

Quapaw, OK | [www.3m.com/boron](http://www.3m.com/boron)  
Sandra Rushin | 918/673-2201 | [boron@mmm.com](mailto:boron@mmm.com)  
Beth Utley | 918/919-2238 | [erutley@mmm.com](mailto:erutley@mmm.com)  
**Codes:** 00400, 16000, 55490, 77800\*

### ABB Inc.

Cary, NC | [www.abb.com](http://www.abb.com)  
Javier Lopez | 305/510-6987 | [javier.lopez@us.abb.com](mailto:javier.lopez@us.abb.com)  
**Codes:** 12800

### Accelerated Decommissioning Partners - ADP

Dallas, TX | <https://www.adpnuclear.com/>  
Curtis Roberts | 202/374-8766 | [curtis.roberts@orano.group](mailto:curtis.roberts@orano.group)  
**Codes:** 20300, 68000, 87000, 93040

### Adam Brown Consulting, Inc.

Cary, IL | <http://linkedin.com/in/adam-brown-7088ab13>  
Adam Brown | 847/287-2616 | [akpbrown@aol.com](mailto:akpbrown@aol.com)  
**Stamps:** ASQC Auditor per ANSI N45.2.23, Level III QC per ANSI N45.2.6  
**Codes:** 06860, 14000, 28150, 40900, 47400, 75190, 86300

### Advanced Consulting Group, Inc.

Chicago, IL  
Tom Litka | 773/481-9500 | [advncsrp@aol.com](mailto:advncsrp@aol.com)  
**Codes:** 03800, 13850, 14000, 20300, 46950, 47400, 47600, 72300, 79360, 86300, 93900

### Advanced Cooling Technologies, Inc.

Lancaster, PA | [www.1-act.com](http://www.1-act.com)  
Bill Anderson | 717/295-6061 | [bill.anderson@1-act.com](mailto:bill.anderson@1-act.com)  
**Codes:** 03800, 14000, 37600

### Advanced Nuclear LLC

Aston, PA | [www.advancednuclear.com](http://www.advancednuclear.com)  
Kevin Fenimore | 706/691-6662 | 800/487-7255 | [kfenimore@irexcorp.com](mailto:kfenimore@irexcorp.com)  
**Codes:** 06790, 11400, 13850, 22800, 28150, 28250, 28270, 41200, 43700, 74350, 77750\*

### Advanced Technologies and Laboratories (ATL) International, Inc. (wholly owned sub. of Planned Systems International, Inc.)

Gaithersburg, MD | <https://www.atlintl.com/>  
Michael Wade | 678/428-5278 | [mwade@atlintl.com](mailto:mwade@atlintl.com)  
Bill Niemeyer | 865/291-8930 | [bniemeyer@atlintl.com](mailto:bniemeyer@atlintl.com)  
**Codes:** 03800, 06860, 09750, 12800, 13850, 14000, 20300, 26080, 26100, 37200, 71190, 77750, 86300, 93040

### Advetage Solutions

El Segundo, CA | [www.advetage.com](http://www.advetage.com)  
Justin Kung | 424/292-8432 | [info@advetage.com](mailto:info@advetage.com)  
**Stamps:** SDVOSB

**Codes:** 09750, 09800, 09880, 10850, 12800, 12900, 14000, 17950, 20300, 20350, 25250, 26230, 37130, 37200, 41000, 55040, 55060, 67380, 69130, 69140, 74400, 77800, 86300\*

### AECON-WACHS (U.S. Div. of Aecon Nuclear)

Jackson, SC | [www.aecon-wachs.com](http://www.aecon-wachs.com)  
Greg Hutchinson | [ghutchinson@aecon.com](mailto:ghutchinson@aecon.com)  
**Stamps:** 10CFR50, Appendix B Program, R; ASME, PP, S & U Certification. NQA-1 Program  
**Codes:** 03000, 06860, 07310, 07800, 13700, 13850, 14000, 14300, 14810, 18400, 22700, 22800, 24180, 26410, 26900, 27450, 28400, 28410, 28500, 28530, 28550, 30500, 33360, 36000, 38000, 40900, 43700, 45250, 46950, 47400, 53950, 54300, 58250, 59800, 59820, 59850, 60100, 60900, 61570, 70650, 71700, 75700, 80800, 80900, 81000, 86130, 87140, 90320, 90600, 90800, 91000, 91380, 92300, 93750, 93800, 93900, 96200\*

### Aegis, LLC

Ooltewah, TN | [www.aegismfg.com](http://www.aegismfg.com)  
Beverly Jerman | 423/790-1376 | [beverly@aegismfg.com](mailto:beverly@aegismfg.com)  
**Codes:** 02910, 03000, 14000, 31650, 75500, 75700

### Aerofin

**See advertisement on page 32**  
Lynchburg, VA | [www.aerofin.com](http://www.aerofin.com)  
Dan Posid | 434/528-6220 | 800/237-6346 | [dposid@aerofin.com](mailto:dposid@aerofin.com)  
**Stamps:** N, NPT, NS, Classes 2, 3; S, U, PP, R, Certification by ISO 9001:2008  
**Codes:** 03000, 37600, 73950, 81790, 83150, 87950, 92300

### AFO Research Inc.

Vero Beach, FL | [www.aforesearch.com](http://www.aforesearch.com)  
Jack Illare | 772/538-1288 | [jackillare@aforesearch.com](mailto:jackillare@aforesearch.com)  
**Codes:** 26910, 26970, 55550, 75850, 77800

### Ahlberg Cameras

**See advertisement on page 99**  
Wilmington, NC | [www.ahlbergcameras.com](http://www.ahlbergcameras.com)  
Drake Courie | 910/612-6814 | [drake.courie@ahlbergcameras.com](mailto:drake.courie@ahlbergcameras.com)  
**Codes:** 09880, 12900, 40900, 45550, 70650, 92800\*

### Alaron Nuclear Services (Veolia Nuclear Solutions Federal Services - Alaron)

Wampum, PA | [www.nuclearsolutions.veolia.com](http://www.nuclearsolutions.veolia.com)  
Peter F. Davin | 412/400-7466 | [peter.davin@alaronnuclear.com](mailto:peter.davin@alaronnuclear.com)  
Don Beal | 201/841-3590 | [donald.beal@alaronnuclear.com](mailto:donald.beal@alaronnuclear.com)  
**Codes:** 11400, 14300, 20300, 20350, 25600, 26230, 68000, 68950, 84600, 87000, 93040, 93900

### Allied Power

**See advertisement on page 83**  
Baton Rouge, LA | [alliedpwr.com](http://alliedpwr.com)  
Dean Sack | 225/412-6455 | [dsack@alliedpwr.com](mailto:dsack@alliedpwr.com)  
**Codes:** 47400



# Directory of Suppliers

ALP-AUR

## Alphasource, Inc.

See advertisement on page 71

Philadelphia, PA | [www.alphasourceintl.com](http://www.alphasourceintl.com)

Andi Bookbinder/Brian Bookbinder | 215/844-6470 | 800/292-7247  
sales@alphasourceintl.com

**Codes:** 00300, 06950, 09400, 09950, 10780, 10900, 12800, 14000, 14300, 20250, 26550, 26600, 29360, 36000, 37130, 37160, 38440, 47200, 47630, 47650, 47670, 61570, 64300, 73300, 75190, 79370, 83110, 83210, 86130, 86300, 95850\*

## American Centrifuge Operating, LLC (sub. of Centrus Energy)

Oak Ridge, TN | [www.centrusenergy.com](http://www.centrusenergy.com)

Ben Jordan | 865/241-7274 | 865/241-7007 | jordanb@centrusenergy.com

**Codes:** 30450, 33200, 89640, 89650

## American DND Engineering, PC

Ellicottville, NY

Jonathan A. Watts | 716/699-5515 | jwatts@stalwarteng.com

Bill Schaab | 716/984-7566 | 716/699-5515 | bschaab@americandnd.com

**Stamps:** Professional Engineers

**Codes:** 13850, 20300, 20700, 25400, 86300, 93040\*

## American DND Inc.

See advertisement on page 9

Grand Island, NY | [www.americandnd.com](http://www.americandnd.com)

Bill Schaab | 716/984-7566 | 866/699-5515 | bschaab@americandnd.com

**Codes:** 06790, 13050, 13850, 14000, 18600, 20250, 20300, 20350, 20700, 25400, 26230, 36820, 73570, 79360, 87000, 93040\*

## F.N. Anderson & Assoc.

Forest, VA | [www.fnaai.com](http://www.fnaai.com)

Floyd N. Anderson | 434/258-3380 | andersonfn@aol.com

**Codes:** 03800, 06860, 12750, 14000, 14300, 25400, 25700, 30700, 77800, 86300

## ANTECH Corp.

Arvada, CO | [www.antech-inc.com](http://www.antech-inc.com)

Matt Piotrowski | 303/430-8184 | piotrowski.matt@antechcorp.com

Alan Lewis | +44 7920839460 | lewis.alan@antech-inc.com

**Codes:** 09800, 09870, 20300, 26230, 44000, 47400, 55040, 68800, 69600, 74150, 79850, 93040\*

## Applied Analysis Corp.

Reading, PA | [www.applied-analysis.com](http://www.applied-analysis.com)

Juan Cajigas | 610/775-0272 | jmcajigas@applied-analysis.com

**Stamps:** Nuclear Quality Assurance Program, 10CFR50 App. B, 10CFR21, ANSI N45.2, and ASME NQA-1

**Codes:** 03800, 12750, 12800, 14000, 25400, 37200, 37660, 40900, 62100, 66200, 77750, 86300

## Applied Science Professionals, LLC (ASP-LLC)

Salt Lake City, UT | [www.asp-llc.com](http://www.asp-llc.com)

Gary M. Sandquist | 801/209-9681 | gms@asp-llc.com

**Stamps:** Certified Health Physicist (ABHP), Certified Quality Auditor (ASQ), PE in Nuclear and Mechanical Engineering, SE in Structural Engineering

**Codes:** 03800, 67380, 86300

## Aptim

Baton Rouge, LA | [www.aptim.com](http://www.aptim.com)

Chris Lee | 801/558-0134 | chris.lee@aptim.com

Dave Lowe | 303/994-4058 | david.lowe@aptim.com

**Stamps:** AMSE U, R, S, Code Stamps

**Codes:** 14000, 35800, 46950, 47400, 93750, 93800, 93900

## Aquasol Corp.

North Tonawanda, NY | [www.aquasolwelding.com](http://www.aquasolwelding.com)

Cheryl Gondek | 716/564-8888 | 800/564-9353 | cgondek@aquasolcorporation.com

|orderdesk@aquasolcorporation.com

**Codes:** 04000, 54750, 61570, 83210, 93800, 95850

## ARES Security Corp.

Vienna, VA | <https://aressecuritycorp.com/>

Jim Raines | 630/956-0519 | jraines@aressecuritycorp.com

**Codes:** 03180, 06860, 12800, 14000, 25300, 40900, 47600, 54000, 55040, 67380, 72300, 73620, 73770, 75500, 75550, 75600, 75850, 78400, 86300, 86500, 93040

## Argonne National Laboratory (EOF Div.)

Lemont, IL | <https://www.anl.gov/eof/facility-decommissioning-training-course>

Lawrence E. Boing | 630/252-6729 | lboing@anl.gov

**Codes:** 14000, 20300, 86300

## Arkema, Inc. (formerly ATOFINA Chemicals, Inc.)

King of Prussia, PA | [www.arkema-americas.com](http://www.arkema-americas.com)

610/205-7000 | 800/225-7788 | arkema.usph-general@arkema-americas.com

**Codes:** 09900, 11400, 17650, 20350, 27450, 28250, 73750

## Arkitek Scientific

Paso Robles, CA | [www.arkitek.com](http://www.arkitek.com)

Beth Anderson | 206/852-8929 | 206/286-0337 | beth@arkitek.com

**Codes:** 12800, 12900, 39960, 53950, 70900, 86300, 86500

## ASI Marine (ASI Group Ltd.)

Orchard Park, NY | [www.asi-group.com](http://www.asi-group.com)

Drew Michel | 512/562-9000 | dmichel@asi-group.com

General Inquiries | 905/643-3283 | info@asi-group.com

**Codes:** 03800, 10780, 14000, 21400, 22700, 39960, 40900, 47400, 92800, 93220, 93900

## ASQ Energy & Environmental Division

Milwaukee, WI | <https://my.asq.org/communities/home/159>

Karen M. Douglas | 505/263-3297 | douglaskm@alumni.stanford.edu

**Stamps:** ASME NQA-1 Quality Assurance Requirements for Nuclear Facility Applications

**Codes:** 86500

## ATS Industrial Automation, Inc. - Nuclear (USA) (ATS Ohio, Inc.)

Lewis Center, OH | <https://atsautomation.com/nuclear>

**Stamps:** Certifications for Ohio, US facilities: ISO-9001:2015; Certifications for Cambridge, Canada facilities: ASME NQA-1; 10CFR50 App. B; 10CFR21 Program; CSA N285.0; CSA N286; CSA N299; CSA B51; ASME B31.1; ASME B31.3; ISO-9001:2015; ISO: 13485:2016

**Codes:** 10780, 11700, 12800, 14000, 20300, 25600, 29900, 30040, 30500, 31700, 40900, 43150, 43400, 47400, 47600, 48050, 59850, 68000, 68950, 70650, 72300, 73300, 73620, 79360, 84000, 86130, 87380, 87400, 87680, 92800, 93040

## Attention IT, Inc. (Attention IT Ltd. (UK))

Knoxville, TN | [www.attentionit.com](http://www.attentionit.com)

Daniel E. Smith | 865/769-8888 x401 | 888/428-8648 | dsmith@attentionit.com

**Codes:** 03800, 06950, 12750, 12800, 14000

## Aurum Technologies

Blackfoot, ID | <https://www.aurumtech.gold>

Jordan McLaughlan | 208/243-1266 | jordan@aurumtech.gold

Nicholas T. Christiansen | 208/521-4791 | nicholas@aurumtech.gold

**Codes:** 03180, 03200, 12800, 12900, 17950, 25000, 25250, 25350, 26080, 37130, 37200, 39960, 55040, 55060, 67380, 72300



### Automation Products, Inc. (Dynatrol Div.)

Houston, TX | [www.dynatrolusa.com](http://www.dynatrolusa.com)  
 Factory Sales Dept. | 713/869-0361 | 800/231-2062 | [sales@dynatrolusa.com](mailto:sales@dynatrolusa.com)  
**Codes:** 04000, 14950, 15200, 25000, 40050, 54750, 82950

### AVANTech, LLC

Columbia, SC | [www.avantechllc.com](http://www.avantechllc.com)  
 Tammy Monday | [tmonday@avantechllc.com](mailto:tmonday@avantechllc.com)  
 James L. Braun | 803/780-3844 | [jbrown@avantechllc.com](mailto:jbrown@avantechllc.com)  
**Stamps:** ASME U Code Stamp, National Board of Boiler and Pressure Vessel Inspectors R and NB, UL Approved, NQA-1

**Codes:** 04000, 08400, 08800, 09900, 09950, 10780, 12800, 12900, 13600, 14000, 14300, 19700, 20300, 22410, 22700, 24170, 25250, 25400, 25600, 26240, 27150, 27180, 27450, 36820, 41700, 47400, 53950, 54750, 55040, 59800, 63400, 64750, 68000, 73620, 74150, 75850, 77800, 79370, 83150, 83600, 84600, 86300, 87000, 91260, 92300, 93040, 93500, 93900

### Babcock Services, Inc.

Kennewick, WA | [www.babcockservices.com](http://www.babcockservices.com)  
 Phil Gallagher | 509/737-0812 | [pgallagher@babcockservices.com](mailto:pgallagher@babcockservices.com)  
 Wally Kennedy | 509/737-0812 | [wkennedy@babcockservices.com](mailto:wkennedy@babcockservices.com)  
**Codes:** 03800, 06860, 10780, 13850, 14000, 14300, 20300, 20350, 20700, 22410, 25400, 30040, 37200, 66280, 68000, 70650, 79360, 79370, 86130, 93040

### Bakelite Synthetics

Atlanta, GA | [www.bakelite.com](http://www.bakelite.com)  
 Product Information | +49 2374 925467 | [information@cldmarcomm.com](mailto:information@cldmarcomm.com)  
**Codes:** 00300, 02870, 11400, 14000, 17650, 47400, 84600\*

### Baker Concrete Construction, Inc.

Houston, TX | [www.bakerconcrete.com](http://www.bakerconcrete.com)  
 Robert Nussmeier | 713/208-1883 | 713/864-0657 | [nussmeierr@bakerconcrete.com](mailto:nussmeierr@bakerconcrete.com)  
**Stamps:** NQA-1  
**Codes:** 13050, 13850, 47400

### Baker Industries, a Lincoln Electric Company

Macomb, MI | [www.bakerindustriesinc.com](http://www.bakerindustriesinc.com)  
 Sean Schaefer | 586/286-4900 | [marketing@bakerindustriesinc.com](mailto:marketing@bakerindustriesinc.com)  
**Stamps:** ISO 9001:2015, ISO 14001:2015, AS9100D, Nadcap Measurement & Inspection, ITAR, ASME BPVC Section IX, AWS CWI, AWS CWS  
**Codes:** 14300, 14810, 17200, 26500, 28300, 30500, 31700, 36000, 37600, 40900, 44080, 44090, 46950, 48050, 49000, 50250, 53950, 54000, 56600, 56750, 59820, 61530, 66200, 66280, 73620, 74350, 77700, 79740, 81710, 82250, 83150, 84150, 84600, 86130, 87380, 87395, 87400, 90100, 92150, 92300, 93800, 93900, 96200

### Banda Group International, LLC

See advertisement on page 124  
 Mesa, AZ | <https://bandagroupintl.com>  
 Zeferino Banda Jr. | 480/636-8734 | [zef@bandagroupintl.com](mailto:zef@bandagroupintl.com)  
**Stamps:** SDVOSB, SBE, MBE  
**Codes:** 03800, 06860, 12800, 14000, 20300, 25400, 93040

### Barge Design Solutions

Nashville, TN | [www.bargedesign.com/](http://www.bargedesign.com/)  
 Andrew Murr | 865/637-2810  
**Codes:** 13850

### Barnhart Nuclear Services

See advertisement on page 55  
 Fairhope, AL | [www.barnhartcrane.com](http://www.barnhartcrane.com)  
 Jim Faux | 901/233-3804 | 800/587-3249 | [jfaux@barnhartcrane.com](mailto:jfaux@barnhartcrane.com)  
**Codes:** 13850, 14000, 18600, 20300, 26240, 47400, 73570, 74600, 81680, 86260, 87000

### G.D. Barri & Associates, Inc.

See advertisement on page 64  
 Peoria, AZ | [www.gdbarri.com](http://www.gdbarri.com)  
 Michelle Manley | 623/773-0410 | [michelle.manley@gdbarri.com](mailto:michelle.manley@gdbarri.com)  
 Alice Granado | 623/773-0410 | [alice.granado@gdbarri.com](mailto:alice.granado@gdbarri.com)  
**Stamps:** QA Program 10CFR50, App. B, ANSI/ASME NQA-1, Pre assessment for ISO 9002, Q Clearances, ES&H Manual, Fitness For Duty Program, Minority Women Owned business.  
**Codes:** 03800, 06860, 09800, 14000, 25350, 25400, 26100, 40900\*

### Basic E, Inc.

Charlotte, VT | [www.basice.com](http://www.basice.com)  
 Charles Kellner | 802/985-5555 | [charles@basice.com](mailto:charles@basice.com)  
**Codes:** 07040, 07070, 07100, 07120, 09400, 11650, 14000, 14950, 24300, 28390, 28400, 35800, 38440, 39650, 41450, 47400, 63400, 63800, 64750, 75190, 77000, 79350, 80200, 82950, 83210, 84100, 86870, 86970, 90000, 90250, 90600, 90800, 91000, 91260, 91380, 95900

### Battery Lane LLC

Carson City, NV | [batterylanellc.com](http://batterylanellc.com)  
 Theodore Weber | 925/289-8368 | [ted@batterylanellc.com](mailto:ted@batterylanellc.com)  
**Codes:** 14000, 26240, 30700, 50300

### Beaudrey American Services

Loveland, CO | [www.beaudrey.com](http://www.beaudrey.com)  
 Mauricio Velez | 754/244-1888 | [m.velez@beaudreyas.com](mailto:m.velez@beaudreyas.com)  
**Stamps:** OSHA, ISO  
**Codes:** 10780, 47400, 93220

### Bechtel (Bechtel Power), (Bechtel Nuclear, Security & Environmental), (Bechtel National)

See advertisement on page 47  
 Reston, VA | [www.bechtel.com](http://www.bechtel.com)  
 Todd Powers | 703/429-6704 | 240/344-9615 | [trpowers@bechtel.com](mailto:trpowers@bechtel.com)  
**Stamps:** ASME Sect. I, VIII and NB: A, NB, PP, R, S, and U ASME Sect. III and NB: N, NA, NPT, and NR; ISO 9001:2015; ISO 14001:2015; ISO 27001:2013; ISO 45001:2018  
**Codes:** 03800, 12800, 13850, 14000, 20300, 47400, 80730

### Berkeley Nucleonics Corp.

San Rafael, CA | [www.berkeleynucleonics.com](http://www.berkeleynucleonics.com)  
 Bernadette Jamieson | 415/453-9955 | 800/234-7858  
[bernadette@berkeleynucleonics.com](mailto:bernadette@berkeleynucleonics.com)  
**Codes:** 09800, 25250, 37200, 41000, 55040, 68800

### Berthold Technologies USA LLC

Oak Ridge, TN | <http://www.berthold.com/en/>  
 Marius Stein | 865/771-6869 | [marius.stein@berthold-us.com](mailto:marius.stein@berthold-us.com)  
**Codes:** 04000, 09750, 09800, 12800, 14000, 17950, 20300, 21270, 21300, 21310, 25250, 37200, 47400, 55040, 55060, 69130, 74150, 75010, 77800

### Bevelacqua Resources (Radiation Protection)

Owens Cross Roads, AL | [www.bevelacquaresources.com](http://www.bevelacquaresources.com)  
 Dr. Joseph Bevelacqua | 509/521-8036 | [bevelres@aol.com](mailto:bevelres@aol.com)  
**Stamps:** American Board of Health Physics Comprehensive Health Physics Certification, Senior Reactor Operator Certification - PWR Certified Radiological Shielding Engineer, Registered Radiation Protection Technologist  
**Codes:** 03800, 06860, 12800, 14000, 17950, 20300, 37200, 86300, 86500\*



# Directory of Suppliers

## BHI-CAR

### BHI Energy - now Westinghouse

See listing for Westinghouse Electric Co.

Cranberry Township, PA | [www.westinghouseuclear.com](http://www.westinghouseuclear.com)

Varesha Mauney | 508/591-1149 | [varesha.mauney@westinghouse.com](mailto:varesha.mauney@westinghouse.com)

Lauren Buckman | 508/591-1150 | [lauren.buckman@westinghouse.com](mailto:lauren.buckman@westinghouse.com)

**Codes:** 03000, 03200, 03800, 06860, 09800, 10780, 11400, 11650, 12720, 12750, 12800, 13050, 13850, 14000, 20300, 20350, 25250, 25300, 25400, 25600, 26080, 26100, 26230, 26970, 27450, 37130, 37200, 40900, 47400, 49700, 57600, 64750, 67380, 70900, 71700, 73570, 74350, 75600, 75850, 77750, 80600, 80730, 80800, 83600, 84600, 86300, 86500, 89500, 90250, 90600, 90800, 91260, 92800, 93040, 93800, 93900\*

### BIRNS, Inc.

Oxnard, CA | [www.birns.com](http://www.birns.com)

Eric F. Birns | 805/487-5393 | 888/247-6788 | [service@birns.com](mailto:service@birns.com)

Eric Christianson | 805/830-5869 | [echristianson@birns.com](mailto:echristianson@birns.com)

**Stamps:** Our Quality Management System is ISO 9001:2015 certified by DNV GL and complies with 10CFR50 App. B. All BIRNS technicians and QA personnel are certified to J-STD-001 Class 3 and WHMA-A-620-A Class 3, and all BIRNS Optical technicians are ETA-I certified. Due to our strong ties to the U.S. Navy we hold DD-2345 certification for militarily critical data and are SUBMEPP-certified to NAVSEA 59320-AM-PRO-020.

**Codes:** 08800, 45550\*

### Black & Veatch

Overland Park, KS | [www.bv.com](http://www.bv.com)

Mark Gake | 913/458-7909 | [gakema@bv.com](mailto:gakema@bv.com)

**Codes:** 03800, 06860, 12750, 12800, 13850, 14000, 20300, 23850, 25700, 28150, 37660, 40700, 40900, 47400, 60900, 63400, 66200, 71190, 73450, 77750, 80600, 80800, 80900, 86300

### Bluegrass Concrete Cutting, Inc.

Greenville, AL | [www.bluegrasscompanies.com](http://www.bluegrasscompanies.com)

Robert M. Hulick | 334/382-9738 | 800/320-1462 | [bhulick@bluegrasscompanies.com](mailto:bhulick@bluegrasscompanies.com)

Kayla Tolbert | 334/382-9738 | 800/320-1462 | [ktolbert@bluegrasscompanies.com](mailto:ktolbert@bluegrasscompanies.com)

**Codes:** 13050, 13850, 20300, 20700

### BNL Industries, Inc.

Vernon Rockville, CT | [www.bnl.com](http://www.bnl.com)

Christopher Bain | 860/870-6222 | [christopher.bain@bnl.com](mailto:christopher.bain@bnl.com)

**Stamps:** N, NPT, Classes 2, 3.

**Codes:** 57050, 90330, 90600, 91260, 91380

### Boston Government Services, LLC (BGS)

See advertisement on page 48

Oak Ridge, TN | [www.bgs-llc.com](http://www.bgs-llc.com)

Paul Adams | 803/257-5226 | 866/730-7353 | [padams@bgs-llc.com](mailto:padams@bgs-llc.com)

Cecil Parks | 865/272-8400 x1118 | [cparks@bgs-llc.com](mailto:cparks@bgs-llc.com)

**Codes:** 03800, 06860, 12750, 12800, 13850, 14000, 18400, 20300, 25400, 68000, 71190, 75600, 86300

### Brandenburg Industrial Service Company

Bethlehem, PA | [www.brandenburg.com](http://www.brandenburg.com)

Timothy Smith | 610/972-8379 | 610/691-1800 | [smitim@brandenburg.com](mailto:smitim@brandenburg.com)

**Codes:** 06790, 20300, 20700

### Brokk Inc. (Sub. of Brokk-Sweden), (Nuclear Div.)

See advertisement on page 45

Santa Fe, NM | [www.brokk.com](http://www.brokk.com)

Tony Marlow | 505/699-8923 | [tony@brokkinc.com](mailto:tony@brokkinc.com)

**Stamps:** Certification by ISO 9001.

**Codes:** 13050, 20300, 20350, 26230, 39650, 47600, 48050, 59850, 68000, 70650, 72300, 73620\*

### Brownstone Psychological Associates

Manitowoc, WI

Stacey Soeldner | [stacey.soeldner@brownstonepa.com](mailto:stacey.soeldner@brownstonepa.com)

**Codes:** 14000, 75600, 84550

### Bureau Veritas Inspection and Insurance Co. (previously OneCIS Inspection and Insurance Co.)

Lynn, MA | <https://www.bvna.com/power-energy/markets/nuclear>

Russell Offringa | 817/337-8328 | 806/662-1969 | [russell.offringa@bureauveritas.com](mailto:russell.offringa@bureauveritas.com)

**Stamps:** ASME Authorized Inspection Agency, ISO 9000, ISO 19443, ANII, ANI, Training

**Codes:** 06860, 07310, 13850, 14000, 40900, 47400, 66200, 80730, 86300

### Burns & McDonnell

Kansas City, MO | [www.burnsmcd.com](http://www.burnsmcd.com)

Glenn Neises | 913/620-5351 | [gneises@burnsmcd.com](mailto:gneises@burnsmcd.com)

**Stamps:** 10CFR50 App. B/NQA-1 QA Program

**Codes:** 03800, 06860, 12720, 12750, 13850, 14000, 19280, 20300, 28000, 28150, 59800, 59850, 60900, 66200, 75600, 86300, 93040

### BWX Technologies, Inc.

Lynchburg, VA | [www.bwxt.com](http://www.bwxt.com)

Joshua Parker | 434/316-7652 | [jlpark2@bwxt.com](mailto:jlpark2@bwxt.com)

**Stamps:** N, NA, NPT, Classes 1, 2, 3 & MC; U, U2, ISO 9001, CSA N285, CSA Z299.1, NQ-A-1, NBIC R, NBIC NR, CSA N286-05, OASES CAT II & III, CSA B51, Q396

**Codes:** 03800, 04000, 10780, 12750, 12800, 13200, 14000, 14300, 15600, 20300, 20350, 20700, 25600, 26970, 28500, 29900, 30000, 30450, 30500, 36870, 37600, 39300, 39400, 40900, 46950, 47400, 47600, 56600, 56750, 56900, 61570, 64120, 68950, 70660, 70665, 70920, 73450, 77750, 80600, 80730, 80800, 81710, 83150, 84150, 84600, 87680, 88100, 89580, 89600, 92300, 92800, 93040, 93800

### C.J. Enterprises (Div. of C.J. Instruments, Inc.)

Tarzana, CA

Marshall Cantor | 818/996-4131 | [cjstruments@aol.com](mailto:cjstruments@aol.com)

**Codes:** 08800, 29200, 50300, 91260, 95900

### CableLAN Nuclear

Fort Myers, FL | [www.cablelannuclear.com](http://www.cablelannuclear.com)

Jonathan Pirrong | 508/384-7811 | 508/247-7243 | [jrpirrong@cablelan.com](mailto:jrpirrong@cablelan.com)

Amy Pirrong | 508/384-7811 | 800/840-6655 | [apirrong@cablelan.com](mailto:apirrong@cablelan.com)

**Stamps:** ASME NQA-1, US NRC 10CFR50, App. B

**Codes:** 08800, 09100, 13400, 26910, 26970, 84150, 95900\*

### Cabrera Services Inc.

East Hartford, CT | [www.cabreraseservices.com](http://www.cabreraseservices.com)

Ellen Montiel | 518/261-0978 | [emontiel@cabreraseservices.com](mailto:emontiel@cabreraseservices.com)

**Codes:** 03800, 06860, 09750, 09800, 14000, 20300, 25250, 26080, 26100, 37200, 41000, 44000, 67380, 69600, 86300, 93040

### Camfil USA, Inc.

Washington, NC | [www.camfil.com](http://www.camfil.com)

Glen Moore | 252/721-8000 | 877/658-6588 | [glen.moore@camfil.com](mailto:glen.moore@camfil.com)

**Codes:** 00400, 03000, 09900, 19450, 21400, 27180, 27450, 36000, 49000, 84150, 90100\*

### Carignan & Associates LLC

Chattanooga, TN | [carignanllc.com](http://carignanllc.com)

Joe Carignan | 423/596-5079 | [jecarignan@outlook.com](mailto:jecarignan@outlook.com)

**Codes:** 14000, 20300, 27450, 37130, 86300



### Carolina Fabricators

West Columbia, SC | [www.carolinafab.com](http://www.carolinafab.com)

Gabe Zeigler | 803/227-0535 | [gzeigler@carolinafab.com](mailto:gzeigler@carolinafab.com)

Brad Hughes | 803/794-4906 | [bhughes@carolinafab.com](mailto:bhughes@carolinafab.com)

**Stamps:** ASME NQA-1, 10CFR50 App. B, 10CFR21, ASME U Stamp, ASME R Stamp

**Codes:** 03000, 07200, 07330, 07340, 07800, 08400, 10780, 11400, 13700, 14300, 14810, 18400, 19450, 22800, 24170, 26900, 27450, 28390, 28400, 28410, 28530, 28550, 30450, 30500, 36000, 36820, 36850, 37600, 39650, 41200, 43700, 46950, 47400, 49000, 50250, 50300, 50350, 53950, 56600, 56750, 57050, 58250, 59800, 59820, 59850, 60100, 60150, 60450, 61570, 66280, 73570, 73590, 74350, 76600, 77700, 77800, 77830, 77860, 77900, 78700, 79000, 79740, 80400, 81710, 82250, 82310, 83150, 86130, 87700, 88000, 88100, 88200, 92300, 93750, 93900, 96200

### CBS Nuclear Services, Inc.

Matthews, NC | [www.cbsnuclear.com](http://www.cbsnuclear.com)

Scott Peterson | 704/882-1875 | [speterson@cbsnuclear.com](mailto:speterson@cbsnuclear.com)

**Codes:** 14000, 24300, 47400, 84150, 84600, 86870, 90000

### Central Research Laboratories

Red Wing, MN | [www.crlsolutions.com](http://www.crlsolutions.com)

Rob Weber | 651/385-2131 | 800/934-1562 | [rweber@crlsolutions.com](mailto:rweber@crlsolutions.com)

Nathan Andersen | 651/385-2113 | [nandersen@destaco.com](mailto:nandersen@destaco.com)

**Codes:** 14300, 20300, 27180, 36000, 47600, 48050, 68000, 72300, 93040\*

### Chesapeake Nuclear Services, Inc.

Annapolis, MD | [www.chesnuc.com](http://www.chesnuc.com)

J. Stewart Bland | 410/266-9174 | [jsbland@chesnuc.com](mailto:jsbland@chesnuc.com)

**Codes:** 12800, 14000, 20300, 25250, 37200, 86300, 93040

### CM Technologies Corp.

Coraopolis, PA | [www.ecadusa.com](http://www.ecadusa.com)

Greg Allan | 412/262-0734 | [greg.allan@ecadusa.com](mailto:greg.allan@ecadusa.com)

**Codes:** 08800, 09750, 12750, 12800, 54750, 69600, 84150, 84600, 86300

### Coastal Network, Inc

Charlottesville, VA | [www.nuclearsupply.com](http://www.nuclearsupply.com)

Michael O. Moyles | 434/978-1204 | [coanetinc@aol.com](mailto:coanetinc@aol.com)

**Codes:** 10850, 10900, 14300, 20350, 23900, 26550, 37130, 47630, 47670, 55040, 55060, 73300, 74150, 83110, 83210, 90100, 95850\*

### Coastal Cable Tools, Inc.

East Syracuse, NY | [www.coastaltools.com](http://www.coastaltools.com)

John F. Lumia | 315/474-4707 | [john@coastaltools.com](mailto:john@coastaltools.com)

**Codes:** 08800, 09750, 09800, 12800, 70650, 86130

### Cohesive

St. Louis, MO | [cohesivegroup.com](http://cohesivegroup.com)

Kat Pullen | 970/666-3378 | [kat.pullen@cohesivegroup.com](mailto:kat.pullen@cohesivegroup.com)

**Codes:** 14000

### Computer Engineering Services, Inc.

Chattanooga, TN | [www.ces-chatt.com](http://www.ces-chatt.com)

Ben Martin | 423/265-0607 | [bmartin@ces-chatt.com](mailto:bmartin@ces-chatt.com)

**Codes:** 12750, 12800, 14000, 19280

### Comtronics

Lexington, KY | <https://www.comtronicsnow.com>

David Fried | 859/299-9494 | 800/264-6021 | [david.fried@comtronicsnow.com](mailto:david.fried@comtronicsnow.com)

**Codes:** 11650

### Concurrent Technologies Corporation (Center for Advanced Nuclear Manufacturing)

Johnstown, PA | [www.ctc.com/canm](http://www.ctc.com/canm)

Dan Markiewicz | 814/269-6873 | 800/CTC-4392 | [canm@ctc.com](mailto:canm@ctc.com)

**Codes:** 11400, 12720, 14000, 19280, 84600, 86130

### Confidential Services, Inc.

South Haven, MI

Beth Warsco | 269/637-8451 | 800/798-1834 | [bwarsco@csish.com](mailto:bwarsco@csish.com)

**Codes:** 75600

### Consolidated Power Supply (Div. of Consolidated Pipe & Supply Co., Inc.)

Birmingham, AL | [www.consolidatedpower.com](http://www.consolidatedpower.com)

Ray Troxell | 205/655-5515 | 800/264-5515 | [ray.troxell@consolidatedpower.com](mailto:ray.troxell@consolidatedpower.com)

**Stamps:** ASME (MS), NPT N-4818, NS N-4819, Classes 1, 2, 3, MC, NF.

**Codes:** 03800, 07330, 11400, 12750, 13400, 13700, 14000, 14300, 15600, 18400, 22800, 23850, 23900, 26900, 27450, 28400, 28410, 28530, 28550, 31700, 36850, 37600, 38000, 40900, 41200, 49000, 50250, 50300, 50350, 54000, 56600, 56750, 57050, 59800, 59850, 60100, 60150, 61570, 77700, 77830, 82250, 82310, 84600, 87140, 87700, 88000, 88100, 88200, 90330, 90600, 90800, 91000, 91260, 91380, 92300, 93800, 96200

### Constellation Clearsight

De Pere, WI | [www.constellationclearsight.com](http://www.constellationclearsight.com)

Chris Place | 267/533-5383 | [christopher.place@constellation.com](mailto:christopher.place@constellation.com)

Jimmy Carter | 267/533-5387 | [jimmy.carter@constellation.com](mailto:jimmy.carter@constellation.com)

**Codes:** 22700, 40900, 73620

### Constellation PowerLabs

See advertisement on page 39

Coatesville, PA | [constellationpowerlabs.com](http://constellationpowerlabs.com)

Daniel Doran | 610/380-2475 | [daniel.doran@constellation.com](mailto:daniel.doran@constellation.com)

**Stamps:** ISO 17025:2020; ANSI/NCSL Z540.3; ANSI N45.2; 10CFR50 App. B; 10CFR21  
**Codes:** 03800, 09750, 09800, 37200, 39300, 39400, 40050, 41000, 44000, 44090, 45550, 77250, 84600, 86750

### Container Products Corporation

Wilmington, NC | [www.c-p-c.net](http://www.c-p-c.net)

910/392-6100 | 800/635-5647 | [cfsales@c-p-c.com](mailto:cfsales@c-p-c.com)

**Stamps:** CE, GOST-R

**Codes:** 11700, 14300, 84600\*

### Container Technologies Industries, LLC

Helenwood, TN | [www.containertechnologies.com](http://www.containertechnologies.com)

Crystal Harrington | 423/569-2800 | [charrington@ctifab.com](mailto:charrington@ctifab.com)

**Codes:** 03800, 10780, 13700, 14300, 25600, 49000, 68000, 75700, 83150

### Conval, Inc.

See advertisement on page 121

Enfield, CT | [www.conval.com](http://www.conval.com)

Don Bowers | 860/749-0761 | [dbowers@conval.com](mailto:dbowers@conval.com)

Kristopher Stevens | 860/749-0761 x223 | [kstevens@conval.com](mailto:kstevens@conval.com)

**Stamps:** ISO 9001 2015; ASME III, Class 1, 2 and 3, N / NPT, CE, PED, Canadian Registration Numbers for all provinces, India IBR

**Codes:** 90250, 90600, 90800, 91000, 91260, 91380\*

### Cooling Technology Institute

Houston, TX | [www.cti.org](http://www.cti.org)

Jalene Fritz | 970/593-8637 | [jfritz@towerperformance.com](mailto:jfritz@towerperformance.com)

Virginia Manser | 281/583-4087 | [vmanser@cti.org](mailto:vmanser@cti.org)

**Codes:** 86200



# Directory of Suppliers

## COR-CUR

### Corrosion Control Services, Inc.

Davenport, IA | [www.corrosioncontrolservice.com](http://www.corrosioncontrolservice.com)  
 Ronald Frantz | 563/324-9076 | 563/343-6595 | [ronfrantz@outlook.com](mailto:ronfrantz@outlook.com)  
**Codes:** 22430, 40900, 47400, 73720, 83150

### Cortec Corp.

Saint Paul, MN | [www.cortecvci.com](http://www.cortecvci.com)  
 Cliff Cracauer | 651/429-1100 | [productinfo@cortecvci.com](mailto:productinfo@cortecvci.com)  
**Codes:** 11400, 14000, 17650, 47400, 57600

### CPMQ Consulting, LLC

Huntsville, AL | [www.linkedin.com/company/cpmq-consulting-llc/](http://www.linkedin.com/company/cpmq-consulting-llc/)  
 Gard Clark | 860/460-6348 | [gard.clark@juno.com](mailto:gard.clark@juno.com)  
**Codes:** 03800, 14000, 86300

### Cragg Consulting

Grapevine, TX  
 Chris Cragg | 682/223-1150 | [chrisragg@gmail.com](mailto:chrisragg@gmail.com)  
**Codes:** 12800, 14000

### CS-2 Inc.

Grand Island, NY | [www.cscs-i.com](http://www.cscs-i.com)  
 Bill Schaab | 716/984-7566 | 866/699-5515 | [cs2@cscs-i.com](mailto:cs2@cscs-i.com)  
**Codes:** 03800, 06790, 06860, 14000, 20250, 20300, 20700, 25400, 40900, 73570, 87000, 93040\*

### CTR Technical Services, Inc.

Manitou Springs, CO | [www.ctr-tech.com](http://www.ctr-tech.com)  
 Charles T. Rombough | 719/685-3805 | [ctr@ctr-tech.com](mailto:ctr@ctr-tech.com)  
**Stamps:** Certification by 10CFR50, 10CFR21.  
**Codes:** 03800, 12750, 12800, 14000, 30600, 56400, 69600, 73450, 86300

### Curie Environmental Services

Albuquerque, NM | [www.curieservices.com](http://www.curieservices.com)  
 Scott Logan | 505/888-9392 | [scott.logan@curieservices.com](mailto:scott.logan@curieservices.com)  
**Codes:** 03800, 68950, 93040

### Curtiss-Wright EST Group

See advertisement on page 94  
 Hatfield, PA | [www.cw-estgroup.com](http://www.cw-estgroup.com)  
 David Kronen | 267/903-5593 | 800/355-7044 | [est-sales@curtisswright.com](mailto:est-sales@curtisswright.com)  
**Stamps:** NUPIC Listed; ISO 9001:2015 Registered. ASME PCC-2  
**Codes:** 26230, 28400, 37600, 47400, 61570, 80730, 84600, 93040\*

### Curtiss-Wright Nuclear Division

See advertisement on page 43  
 Brea, CA | [www.cwnuclear.com](http://www.cwnuclear.com)  
 Gary Wolski | 714/337-2512 | [gwolski@curtisswright.com](mailto:gwolski@curtisswright.com)  
**Codes:** 03000, 03180, 03500, 03800, 04000, 06860, 06950, 07040, 07070, 07330, 07340, 07800, 08400, 08800, 09100, 09800, 12100, 12800, 12900, 13180, 13200, 13400, 13700, 14000, 14300, 14950, 15200, 18400, 18600, 19450, 19700, 21400, 22200, 22660, 22800, 23850, 24300, 25000, 25400, 26080, 26190, 26230, 26240, 26900, 26910, 26970, 27150, 27450, 28150, 28400, 28530, 30500, 30600, 33360, 33400, 36800, 37600, 37800, 38440, 39650, 40050, 40700, 40900, 41000, 41450, 42870, 43700, 45250, 45550, 46810, 46950, 47400, 49000, 50300, 50350, 53950, 54750, 55300, 56600, 56750, 57000, 58250, 60100, 60900, 61570, 62910, 63400, 64750, 66200, 66280, 67380, 69600, 70600, 70650, 71190, 71700, 72300, 73450, 73590, 73620, 74320, 75190, 75600, 75700, 75850, 76400, 77250, 77750, 77800, 77830, 78200, 78400, 79360, 79740, 80600, 80730, 81680, 81710, 82950, 83150, 83210, 84000, 84150, 84600, 85000, 85700, 86130, 86200, 86300, 86500, 86750, 86870, 86970, 90280, 90330, 90600, 90800, 91000, 91260, 91380, 92300, 93220, 93800, 95900, 96200

### Curtiss-Wright Nuclear Division, Anatec

Brea, CA | [www.cwnuclear.com](http://www.cwnuclear.com)  
 Darren Howe | 949/271-7520 | [dhowe@curtisswright.com](mailto:dhowe@curtisswright.com)  
 Fred Hall | 320/316-3531 | [fhall@curtisswright.com](mailto:fhall@curtisswright.com)  
**Codes:** 56600, 73620, 84150, 84600, 86300\*

### Curtiss-Wright Nuclear Division, AP Services

Middleburg Heights, OH | [www.cwnuclear.com](http://www.cwnuclear.com)  
 Mike Sheehan | 724/295-6200 | [msheehan@curtisswright.com](mailto:msheehan@curtisswright.com)  
**Codes:** 14000, 36800, 43700, 75190, 77830, 78200, 90280, 90330, 93800

### Curtiss-Wright Nuclear Division, Enertech

Brea, CA | [www.cwnuclear.com](http://www.cwnuclear.com)  
 John Knezevic | 714/982-1927 | [jknezevic@curtisswright.com](mailto:jknezevic@curtisswright.com)  
**Stamps:** N, Classes 1, 2, 3 Valves, NPT, Classes 1, 2, 3, Valves & Appurtenances & Component Supports; NV Classes 1, 2, 3; NU; NA.  
**Codes:** 03800, 09800, 14000, 25400, 26230, 37600, 39650, 40050, 40900, 41000, 47400, 54750, 56600, 86300, 86500, 91260, 91380

### Curtiss-Wright Nuclear Division, LMT

Hutchinson, MN | [www.cwnuclear.com](http://www.cwnuclear.com)  
 Jeff Devers | 501/397-2831 | [jdevers@curtisswright.com](mailto:jdevers@curtisswright.com)  
 Fred Hall | 320/316-3531 | [fhall@curtisswright.com](mailto:fhall@curtisswright.com)  
**Codes:** 56600, 84150, 84600, 86300

### Curtiss-Wright Nuclear Division, NETCO

Danbury, CT | [www.cwnuclear.com](http://www.cwnuclear.com)  
 Scot Leuenroth | 203/448-3310 | [sleuenroth@curtisswright.com](mailto:sleuenroth@curtisswright.com)  
**Codes:** 03800, 12800, 14000, 14300, 30600, 66200, 70600, 81680, 84600, 86300

### Curtiss-Wright Nuclear Division, Nova

Middleburg Heights, OH | [www.cwnuclear.com](http://www.cwnuclear.com)  
 Mike Rea | 216/898-8017 | [mrea@curtisswright.com](mailto:mrea@curtisswright.com)  
**Stamps:** 10CFR50 App. B; 10CFR21; ASME NQA-1; ASME Section III Class 1, 2, 3, CS and MC/MO; ANSI N45.2; CSA Z299.1, Z299.4 (Canada); ISO 9001:2008; ISO 17025:2005; EPRI NP-5652, TR-102260 & TR-017218-R1; MIL-I-45208, MIL-STD-45662, MIL-STD-271  
**Codes:** 07330, 07340, 07800, 13700, 14000, 18400, 26900, 28400, 39650, 46810, 46950, 47400, 50300, 50350, 60100, 61570, 64750, 73590, 77830, 79740, 84000, 86130\*

### Curtiss-Wright Nuclear Division, QualTech NP

Cincinnati, OH | [www.cwnuclear.com](http://www.cwnuclear.com)  
 Darryl Deist | 931/759-4237 | [ddeist@curtisswright.com](mailto:ddeist@curtisswright.com)  
**Stamps:** ASME N, NA & NPT, Classes 1, 2, 3 & MC.  
**Codes:** 03000, 03500, 03800, 06860, 06950, 07040, 07070, 08400, 08800, 09100, 12100, 13180, 13200, 13400, 14000, 14950, 15200, 18600, 19450, 21400, 22200, 22660, 22800, 24300, 25000, 26080, 26910, 26970, 27450, 28150, 28400, 28530, 33360, 33400, 37600, 37800, 38440, 40050, 40900, 41450, 45250, 45550, 46950, 47400, 49000, 55300, 56600, 58250, 60100, 63400, 69600, 75190, 75700, 76400, 77250, 79350, 79740, 82950, 83150, 83210, 84100, 84600, 85000, 85700, 86130, 86200, 86300, 86750, 86870, 86970, 90600, 90800, 91000, 91380, 92300, 93220, 95900\*

### Curtiss-Wright Nuclear Division, Scientech

Idaho Falls, ID | [www.cwnuclear.com](http://www.cwnuclear.com)  
 Theresa Sutter | 208/497-3333 | [tsutter@curtisswright.com](mailto:tsutter@curtisswright.com)  
 Sean Fuller | 208/497-3333 | [sfuller@curtisswright.com](mailto:sfuller@curtisswright.com)  
**Stamps:** ASME Stamps/Symbols - CSA and TSSA  
**Codes:** 03180, 03800, 04000, 06860, 12750, 12800, 12900, 14000, 19700, 23850, 24300, 26190, 26240, 27150, 30040, 30500, 30600, 33400, 40700, 42870, 47400, 53950, 54750, 56750, 57000, 58250, 60900, 61570, 63400, 66200, 66280, 67380, 69600, 70600, 70650, 71190, 71700, 72300, 73450, 74320, 75190, 75600, 75850, 76400, 77750, 77800, 78400, 79360, 79740, 80600, 80730, 81680, 81710, 84000, 84600, 86130, 86300, 96200\*





### Cutting Technologies (CTI)

Gloucester City, NJ | [www.cuttingtechnologies.com](http://www.cuttingtechnologies.com)  
Bob Frazier | 856/456-2255 | [solutions@cuttingtechnologies.com](mailto:solutions@cuttingtechnologies.com)  
**Codes:** 13050, 13700, 20300, 22700, 36900, 39960, 47400, 55040, 56600, 73570

### Czufin Consulting, LLC

Wilmington, NC | [www.czufin.com](http://www.czufin.com)  
David Czufin | 815/342-4565 | [czufin@gmail.com](mailto:czufin@gmail.com)  
**Codes:** 14000

### DC Fabricators Inc.

Florence, NJ | [www.dcfab.com](http://www.dcfab.com)  
Christina Domansky | 609/499-3000 x244 | [cdomansky@dcfab.com](mailto:cdomansky@dcfab.com)  
Lyndsey Rifici | 609/499-4100 | 717/324-0662 | [lrifici@dcfab.com](mailto:lrifici@dcfab.com)  
**Stamps:** TEMA Standards  
**Codes:** 03000, 13180, 13200, 13220, 37600

### DCS Systems, Inc.

Simsbury, CT  
George D. Dooley | 860/651-0218 | 860/916-0966 | [gddooley@dcssystem.com](mailto:gddooley@dcssystem.com)  
Joseph A. Dooley | 860/651-0218 | 860/916-1279 | [jadooley@dcssystem.com](mailto:jadooley@dcssystem.com)  
**Codes:** 03800, 06860, 12750, 12800, 14000, 25400, 30600, 40900, 66200, 73450, 86300

### Deep Isolation, Inc.

Berkeley, CA | [www.deepisolation.com](http://www.deepisolation.com)  
Sophie McCallum | 415/990-4838 | [sophie@deepisolation.com](mailto:sophie@deepisolation.com)  
**Codes:** 68000, 93040

### Del Mar Avionics (Hydra Set Div.)

Irvine, CA | [www.dma.com](http://www.dma.com)  
Jim Singley | 949/623-1202 | [jsingley@dma.com](mailto:jsingley@dma.com)  
**Stamps:** ISO 9001:2015  
**Codes:** 18600\*

### The Delphi Groupe, Inc.

Austin, TX | [www.delphigroupe.com](http://www.delphigroupe.com)  
R. D. Gauny | 512/462-1181 | [rdgauny@delphigroupe.com](mailto:rdgauny@delphigroupe.com)  
**Codes:** 03800, 06860, 14000, 20300, 20350, 25400, 26100, 37200, 40900, 47400, 71190, 86300, 93040

### Deltech Furnaces (Deltech, Inc.)

Denver, CO | [www.deltechfurnaces.com](http://www.deltechfurnaces.com)  
J.J. Stevenson | 303/645-3935 | 303/433-5939 | [jj@deltechfurnaces.com](mailto:jj@deltechfurnaces.com)  
**Stamps:** ISO 9001:2015 certified; ASME NQA-1:2008 quality assurance; UL508A compliant control systems as certified by Intertek  
**Codes:** 31600, 68000

### Deltech Kiln and Furnace Design, LLC

Denver, CO | [www.dkfdllc.com](http://www.dkfdllc.com)  
J.J. Stevenson | 303/645-3935 | [jj@dkfdllc.com](mailto:jj@dkfdllc.com)  
Mary Stevenson | 303/645-3936 | [mary@dkfdllc.com](mailto:mary@dkfdllc.com)  
**Stamps:** ISO 9001:2015 ASME NQA-1 2008  
**Codes:** 31600, 68000

### Desco Mfg. Co., Inc.

Rancho Santa Margarita, CA | [www.descomfg.com](http://www.descomfg.com)  
Tom Sistrunk | 949/858-7400 | 800/337-2648 | [tsistrunk@descomfg.com](mailto:tsistrunk@descomfg.com)  
**Codes:** 00300, 06790, 10780, 13050, 14000, 20350, 29360, 68000, 73750, 86130, 90100\*

### DETEK

Temple Hills, MD | [www.detek.com](http://www.detek.com)  
Tim Flaherty | 301/449-7300 | 800/638-0554 | [sales@detek.com](mailto:sales@detek.com)  
**Codes:** 03200, 17950, 21270, 37130, 55060, 56600, 68800, 73300, 84150, 86300

### Deytec, Inc.

Ashburn, VA | [www.deytecinc.com](http://www.deytecinc.com)  
Dr. Monideep Dey | 703/729-1687 | [deytec@frontiernet.net](mailto:deytec@frontiernet.net)  
**Codes:** 03800, 12800, 14000, 73450, 86300, 86500

### DLE Technical Services, LLC (BlueDragon Critical Thinking and Complex Problem Solving Workshops)

Palm City, FL | [www.bluedragon1-ips.com](http://www.bluedragon1-ips.com)  
Rob De La Espriella | 772/341-1093 | [rob@bluedragon1.com](mailto:rob@bluedragon1.com)  
**Codes:** 03800, 14000, 86300\*

### Dominion Engineering, Inc.

**See advertisement on page 49**  
Reston, VA | [www.domeng.com](http://www.domeng.com)  
Dale Vines | 703/657-7300 | 225/305-3428 | [dvines@domeng.com](mailto:dvines@domeng.com)  
**Codes:** 03800, 06870, 09880, 10780, 12800, 14000, 17650, 20250, 20300, 20350, 27180, 27250, 27450, 30500, 40900, 47400, 54750, 60900, 68000, 70650, 73450, 80730, 83600, 84600, 93040

### Dragon Valves, Inc.

Norwalk, CA | [www.dragonvalves.com](http://www.dragonvalves.com)  
C. R. Bond | 562/921-6605 | 800/966-4007 | [info@dragonvalves.com](mailto:info@dragonvalves.com)  
**Stamps:** NUPIC Audited ASME NQA-1 and 10CFR50 App. B Program. ASME N Stamp Certification (N-4845).  
**Codes:** 57050, 90250, 90600, 90800, 91260\*

### DuBose National Energy Services, Inc.

**See advertisement on page 93**  
Clinton, NC | [www.dubosenes.com](http://www.dubosenes.com)  
Beau Laslo | 910/590-2151 | 800/590-2151 | [beau.laslo@dubosenes.com](mailto:beau.laslo@dubosenes.com)  
**Stamps:** NPT Class 1, 2, 3, CS, MC, TC & SC (without design); NS Class 1, 2, 3 & MC Fabrication (without design)  
**Codes:** 07330, 07340, 07800, 10010, 13700, 14300, 18400, 26900, 28400, 28410, 28530, 28550, 30500, 36850, 37600, 46950, 48300, 48950, 49000, 50250, 50300, 50350, 56600, 57050, 59800, 59820, 59850, 60100, 60150, 60450, 61570, 66280, 73590, 75700, 77700, 77830, 78700, 79740, 81790, 82250, 82310, 83150, 85700, 87140, 88100, 88200, 92300, 93800, 93900, 96200

### Dufrane Nuclear Shielding Inc. (Dufrane Nuclear Inc.)

Winsted, CT | [www.dufranenuclear.com](http://www.dufranenuclear.com)  
Tom Herr | 203/885-5132 | [therr@dufrane.com](mailto:therr@dufrane.com)  
Tim Tarbox | 479/886-0345 | [tarbox@dufrane.com](mailto:tarbox@dufrane.com)  
**Codes:** 03800, 06860, 09950, 11650, 13050, 13700, 13850, 14000, 14300, 20300, 27150, 37130, 37200, 47400, 49000, 55490, 57400, 66280, 68000, 73570, 75700, 77750, 77800, 87000, 93500, 95750, 96200\*

### DW James Consulting, LLC

North Oaks, MN | [www.dwjames.com](http://www.dwjames.com)  
Thomas Kalinowski | 651/482-7556 | [support@dwjames.com](mailto:support@dwjames.com)  
**Codes:** 03800, 06860, 12800, 14000, 20300, 26100, 37200, 55500, 68000, 77750, 86300, 87000, 93040, 93240

### E.H. Wachs (A Div. of ITW)

Lincolnshire, IL | [www.ehwachs.com](http://www.ehwachs.com)  
Ron Rohrbacher | 847/537-8800 | 800/323-8185 | [sales@ehwachs.com](mailto:sales@ehwachs.com)  
**Codes:** 14000, 20300, 26230, 28500, 28530, 37600, 39650, 46950, 47400, 59850, 64750, 68000, 70650, 72300, 80730, 86130, 86300, 90250, 90800, 93800\*

### Eastern Technologies, Inc. (OREX; PolyZolv)

Ashford, AL | [www.orex.com](http://www.orex.com)  
Mark Fellows | 334/899-4351 | [mfellows@orex.com](mailto:mfellows@orex.com)  
Doug Kay | 817/559-0506 | [dkay@orex.com](mailto:dkay@orex.com)  
**Codes:** 10850, 10900, 14300, 26600, 37130, 37160, 37200, 55040, 95850\*



# Directory of Suppliers

EBE-ENV

## Ebersen, Inc.

Minneapolis, MN

Chidi N. Anunka | 763/572-2661 | 612/422-7409 | eberson@att.net

**Codes:** 14000, 30700, 87000, 89650, 89760

## ECC

Burlingame, CA | www.ecc.net

Margie Nienhaus | 720/684-8610 | mnienhaus@ecc.net

Doug McClure | 508/988-0328 | dmccclure@ecc.net

**Codes:** 03800, 14000, 20300, 26100, 37200, 93040

## Eckert & Ziegler Analytics

Atlanta, GA | [https://www.ezag.com/home/products/isotope\\_products/isotrak\\_calibration\\_sources/](https://www.ezag.com/home/products/isotope_products/isotrak_calibration_sources/)

Eric Brown | 404/425-5068 | eric.brown@ezag.com

**Codes:** 09800, 67380, 68950

## EFCO USA, Inc.

Charlotte, NC | www.efcousa.com

Sales | 800/EFCO-USA | 800/332-6872 | sales@efcousa.com

Christian Mossberg | 704/492-6875 | 800/EFCO-USA | christian@efcousa.com

**Codes:** 00300, 26230, 28500, 37600, 44070, 59850, 84150, 86130, 86300, 90320\*

## EK USA, Inc. (EK Eccessories, Inc.)

Logan, UT | www.ekusa.com

Alan Hochberg | 435/753-8448 | 800/338-2030 | alan@ekusa.com

**Codes:** 10900, 37200, 75500, 75850\*

## Elcometer Education Institute

Warren, MI | www.elcometeredu.com/

Deb Piatt | 248/650-0500 | training@elcometerusa.com

**Codes:** 86300, 86400, 86500

## Elcometer, Inc.

Warren, MI | www.elcometerusa.com

Sunny Nietubicz | 248/650-0500 | 800/521-0635 | sales@elcometerusa.com

**Stamps:** Certification by ISO 9001:2015, ISO/IEC 17025:2017

**Codes:** 03800, 04000, 10850, 10900, 26080, 56600, 84150\*

## Electrical Builders Inc. (EBI)

St. Cloud, MN | www.electricalbuilders.com

Jessica Netter | 320/257-9008 | 877/297-0616 | jnetter@electricalbuilders.com

**Stamps:** ISO 9001:2015, WBENC, WOSB, VET, ANS, NSC, IBEW

**Codes:** 03800, 07200, 10100, 13850, 14000, 20250, 20350, 24180, 24300, 28270, 40900, 43700, 47400, 49000, 50300, 51850, 56600, 61530, 63400, 75190, 77250, 79740, 82250, 84600, 93750, 93900\*

## Electro Static Technology

Mechanic Falls, ME | www.est-aegis.com

Sunshine Spaulding | 207/998-1222 | 866/738-1857 | sunshine.spaulding@est-aegis.com

**Codes:** 47400, 64480, 64700, 75190\*

## Element Nuclear (NTS Labs) (Nuclear Engineering & Test Services)

See advertisement on page 113

Huntsville, AL | www.element.com

Greg Mason | 256/603-0903 | greg.mason@element.com

**Stamps:** A2LA, ISO9001, IEEE ICAP 3-Star rating, Radioactive Material License

**Codes:** 02870, 03200, 03800, 07100, 07120, 08800, 09800, 12800, 12900, 14000, 14300, 14950, 19280, 19700, 20000, 24300, 26080, 40050, 40900, 47400, 53950, 54750, 56600, 63400, 76400, 76600, 77250, 77860, 79000, 82950, 84100, 84430, 84600, 86970, 90000, 93040

## Ellis & Watts Global Industries, Inc. (a sub. of Marmon®, a Berkshire Hathaway company)

Batavia, OH | www.elliswatts.com

Jacob Bolden | 513/943-3327 | jbolden@elliswatts.com

**Stamps:** ASME B&PV Code Section III, Division 1, Class 2 & 3: N Stamp, NA Stamp, NS Stamp, NPT Stamp; ASME B&PV Code Section VIII, Division 1: U Stamp, UM Stamp; ASME NQA-1; ASME AG-1; IEEE Class 1E; CE Certificate (European Pressure Equipment); CRN Registered (Canada)

**Codes:** 00400, 03000, 12100, 13180, 14000, 19450, 22800, 27180, 27250, 27450, 32250, 37600, 37800, 39650, 54300, 55300, 71500, 73950, 77700, 77750, 79740, 80600, 84600, 90250, 92300

## Encorus Group

Springville, NY | www.encorus.com

Kevin Opp | 716/592-3980 x150 | kopp@encorus.com

**Stamps:** ASME NQA-1, API, SP001, NACE, CWI, NBIC

**Codes:** 12750, 14950, 20300, 25400, 26100, 47600, 53950, 74320, 77700, 77750, 86130, 93040

## Energy Resources International Inc.

Washington, DC | www.energyresources.com

Eileen M. Supko | 703/627-5934 | supko@energyresources.com

**Codes:** 03800, 12800, 14000

## Energy Steel

Rochester Hills, MI | www.energysteel.com

Mike Lonsberry | 517/285-2988 | 866/261-3772 | mlonsberry@energysteel.com

**Stamps:** ASME III Div 1/3; N, NPT, NA, NS, U, R Stamps/Certificates; 10CFR Part 21; 10CFR50 App B; ANSI N45.2; NQA-1; MIL-145208A.

**Codes:** 03000, 03800, 07100, 07120, 07200, 13600, 13850, 14300, 19450, 20300, 22800, 26900, 27180, 28400, 37600, 37780, 47400, 49000, 57050, 57400, 57600, 59800, 59820, 60900, 61570, 64700, 64750, 71900, 77830, 77860, 83120, 83150, 90250, 93900

## Energy, Technology and Environmental Business Association (ETEBA)

Oak Ridge, TN | www.eteba.org

Terri Reedy | 865/643-2302 | terri@eteba.org

**Codes:** 14000, 86300, 93040

## EnergySolutions

See advertisement on page 11

Salt Lake City, UT | www.energysolutions.com

Mark Walker | 801/649-2000 | mwalker@energysolutions.com

**Codes:** 03800, 04000, 06860, 09800, 09950, 10780, 10850, 14000, 14300, 17950, 20300, 20350, 22410, 25400, 25600, 26230, 27180, 27450, 30040, 30500, 36820, 37200, 41000, 41700, 44000, 55040, 68000, 74150, 77800, 79360, 80600, 81680, 84600, 86260, 86300, 86500, 87000, 93040, 93500

## EnerSys

Reading, PA | www.enersys.com

George Brendahl | 610/208-1746 | george.brendahl@enersys.com

**Codes:** 07040

## Engineered Rigging

Russellville, AR | www.engineeredrigging.com

Christopher Cox | 844/474-4448 | ccox@engineeredrigging.com

Eddy Kitchen | 804/814-4844 | eddy@engineeredrigging.com

**Codes:** 13850, 14000, 18600, 25400, 26230, 28400, 45350, 47400, 48050, 49000, 73570\*

## Environmental Restoration Group, Inc.

Albuquerque, NM | www.ergoffice.com

Chuck Farr | 505/298-4224 | chuckfarr@ergoffice.com

**Codes:** 06860, 09800, 12750, 12800, 14000, 17950, 20300, 25250, 26080, 26100, 26230, 37130, 37200, 41000, 47400, 55040, 55060, 69130, 69140, 73300, 86300, 93040



### EPD

Carlsbad, NM | nftinc.com  
James Prentiss | 575/234-5600  
**Codes:** 46950, 93900

### ETAP - Operation Technology, Inc.

Irvine, CA | etap.com  
Mary J. Beal | 949/900-1000 | sales@etap.com  
**Stamps:** United States Code (U.S.C.) Title 10CFR50, App. B United States Code (U.S.C.) Title 10CFR21; ANSI/ASME N45.2-1977; ASME NQA-1 (Includes Subpart 2.7); ISO 9001:2008 Registered Certification Number 10002889 QM08; ANSI/IEEE Std 730.1-1995 CAN/CSA-Q 396.1.2-1989; ANSI N45.2.2-1972  
**Codes:** 03800, 12750, 12800, 80730, 80800, 80900\*

### Evident Scientific, Inc. (Evident Corp.)

Webster, TX | www.evidentscientific.com  
Kristopher Lee | 281/922-9300 | kristopher.lee@evidentscientific.com  
**Codes:** 03800, 56600, 73300\*

### EXCEL Services Corporation

See advertisement on page 1  
Rockville, MD | www.excel-services.com  
Donald R. Hoffman | 301/984-4400 | donald.hoffman@excelservices.com  
**Codes:** 03800, 06860, 12720, 14000, 19280, 20300, 25400, 41000, 47400, 75600, 86300

### F.E. Moran Special Hazard Systems

Northbrook, IL | www.femor.com  
Daryl Bessa | 847/291-6336 | daryl.bessa@femor.com  
Yolanda Troxell | 847/421-7929 | yolanda.troxell@femor.com  
**Codes:** 03180, 03200, 12800, 28000, 64750, 86300

### F&J SPECIALTY PRODUCTS, INC.

See advertisement on page 103  
Ocala, FL | www.fjspecialty.com  
Sales Coordinator | 352/680-1177/1178 | 888/832-5037 | fandj@fjspecialty.com  
**Stamps:** ISO 9001:2015, ISO 17025  
**Codes:** 03000, 09750, 09800, 09900, 25250, 26080, 27250, 27450, 37130, 37200, 55040, 64750, 74150, 84150\*

### FabOhio, Inc.

Uhrichsville, OH | www.fabohio.com  
Kurt Shelley | 740/922-4233 | kshelley@fabohio.com  
**Codes:** 10850, 10900, 14300, 27180, 37130, 55040

### FCI-Fluid Components International

San Marcos, CA | www.fluidcomponents.com/nuclear  
Nathan Obermiller | 760/744-6950 | 800/854-1993 | nuclear@fluidcomponents.com  
Melinda Crooks | 760/744-6950 | 800/854-1993 | eflow@fluidcomponents.com  
**Stamps:** IEEE 323, IEEE 344, IEEE 383 Class 1E Seismic Category 1, ISO9001, NUPIC, HAF 604, MIL-STD 45662A, ANSI/ASME NQA-2  
**Codes:** 03200, 09800, 14950, 23900, 25000, 40050, 54750, 55040, 69600, 77250, 82950, 86970\*

### Framatome Inc. (North American Headquarters)

See advertisement on pages 6-7  
Lynchburg, VA | www.framatome.com  
Donna Gaddy-Bowen | 434/832-3702 | donna.gaddybowen@framatome.com  
**Stamps:** ASME III N, NPT Stp.; ASME I S Stp.; ASME VIII Div. 1 U Stp.; Nat'l. Brd. Nuclear Cmpts., Mod/Repl/Repair NR Stp. & Pressure Retng. Items Repair/Alter R Stp.; N, NR, NPT, ISO 9001.  
**Codes:** 00400, 03000, 03200, 03800, 04000, 06820, 06860, 08400, 08800, 09730, 09750, 09800, 10780, 11400, 11700, 12720, 12750, 12800, 12900, 13200, 13400, 14000, 14300, 14810, 14950, 15200, 15600, 16000, 17200, 18600, 19280, 19700, 20250, 20350, 21320, 21400, 22150, 22410, 24000, 24300, 25000, 25250, 25350, 25400, 26100, 26230, 26900, 26970, 27150, 27450, 28000, 28100, 28150, 28550, 29900, 30000, 30040, 30450, 30500, 30600, 31600, 31700, 32250, 36870, 37130, 37200, 37600, 37780, 37800, 38000, 39300, 39400, 39960, 40050, 40775, 40900, 41000, 41700, 44080, 44090, 45250, 45550, 45700, 46200, 46950, 47400, 47600, 48050, 48300, 49000, 51850, 53950, 54000, 54750, 55040, 55060, 55300, 55470, 55490, 55500, 55550, 56400, 56600, 56750, 56900, 57400, 58000, 58800, 59800, 59850, 60450, 60900, 61570, 61800, 64000, 64120, 64700, 66200, 66280, 68900, 68950, 69600, 70600, 70650, 70900, 71100, 71190, 71700, 72300, 73300, 73450, 73550, 73620, 74150, 74320, 75190, 75600, 75850, 76400, 76600, 77250, 77600, 77700, 77750, 77800, 78400, 79350, 79740, 80600, 80730, 80800, 80900, 81000, 81680, 81790, 82200, 82250, 82950, 83150, 83600, 84000, 84150, 84430, 84600, 85000, 85700, 86130, 86150, 86200, 86250, 86260, 86300, 86400, 86500, 87000, 87680, 88000, 88100, 90000, 90250, 90280, 90320, 90600, 90800, 91000, 91260, 91380, 92300, 92800, 93220, 93240, 93500, 93750, 93800, 93900, 96200

### Free Form Fibers

Saratoga Springs, NY | https://fffibers.com/  
Jeff Vervlied | 215/768-4076 | jvervlied@fffibers.com  
**Codes:** 00300, 10100, 55490, 77800

### Frham Safety Products, Inc.

See advertisement on page 41  
Rock Hill, SC | www.frhamsafety.com  
Trip McGarity | 803/366-5131 | trip@frhamsafety.com  
**Codes:** 03000, 08400, 09400, 09550, 10780, 10850, 10900, 11400, 11650, 24080, 25250, 26080, 26100, 26600, 27450, 36000, 37130, 37160, 45550, 47630, 47670, 68000, 73550, 74150, 77800, 79370, 83110, 83210, 95850\*

### Fronek - Anchor Darling Enterprises, Inc. (Sub. of Piping Technology & Products, Inc.)

Laconia, NH | www.fronekgrp.com  
Walter Paszul | 603/528-1931 | walter@fronekgrp.com  
**Stamps:** ASME NS, Class 1, 2, 3; 10CFR50 App. B; ANSI N45.2  
**Codes:** 60100, 79000

### Frontier Technology Corp.

Xenia, OH | www.frontier-cf252.com  
Trevia Janzow | 937/376-5691 | t.janzow@frontier-cf252.com  
**Codes:** 14300, 25600, 68950, 77800

### Fuel Tank Maintenance Co., LLC

Cookeville, TN | fueltankmaintenance.com  
Jerry Hahn | 615/355-5636 | 800/742-2417 | jthahnjr@hotmail.com  
**Stamps:** SSPC, QP1, QP2; NACE Level 1, Level 2.  
**Codes:** 03800, 06790, 11400, 13050, 13850, 14000, 17650, 20300, 20350, 22430, 25400, 30500, 40900, 45700, 47400, 56600, 73350, 73400, 74320, 75700, 75850, 80730, 83150, 84600, 92300, 93040, 93500, 93900

### Full On Communications

Woodstock, VT | www.fulloncom.com  
Jarret Adams | 202/815-9234 | info@fulloncom.com  
**Codes:** 14000, 64312



# Directory of Suppliers

## GAM-GSE

### Gamma Reality Inc.

Richmond, CA | [www.gammareality.com](http://www.gammareality.com)  
Erika Suzuki | 510/542-9025 | [esuzuki@gammareality.com](mailto:esuzuki@gammareality.com)  
Andy Haefner | 510/542-9025 | [info@gammareality.com](mailto:info@gammareality.com)  
**Codes:** 12800, 17950, 25250, 26080, 39960, 44080, 44090, 55040, 58800, 73450, 77000

### GE Hitachi Nuclear Energy

Wilmington, NC | [nuclear.gepower.com](http://nuclear.gepower.com)  
Jon Allen | 910/819-2581 | [jonathan.allen1@ge.com](mailto:jonathan.allen1@ge.com)  
**Stamps:** N, NA, NPT, U and NR, Classes 1, 2, 3, CS, MC and as a Material Supplier, Pressure Vessels, Repair, Modification or Replacement.  
**Codes:** 03200, 03800, 04000, 06870, 07310, 08400, 08800, 09750, 09800, 09900, 12750, 12800, 12900, 13600, 13850, 14000, 14300, 14810, 14950, 15200, 15600, 16000, 16800, 17200, 17950, 19700, 20000, 20350, 21270, 21400, 22660, 22800, 23850, 24000, 25000, 25600, 26080, 26100, 26190, 26240, 26900, 26970, 27450, 28300, 29900, 30000, 30500, 30600, 30700, 31600, 31700, 32250, 36870, 37200, 37600, 37780, 37800, 38000, 39400, 39650, 40900, 41000, 42600, 46950, 47400, 47600, 49000, 50000, 50350, 53950, 54750, 55040, 55470, 55490, 55500, 56400, 56600, 56900, 57000, 58000, 58250, 60450, 60900, 64750, 66200, 66280, 69600, 70600, 71190, 71700, 72000, 72300, 73300, 73450, 74150, 74320, 75600, 76400, 76600, 77750, 77860, 78400, 79000, 79740, 80600, 81680, 81790, 84000, 84150, 84600, 85000, 86400, 88100, 90250, 92300, 93500, 93750, 93900, 96200

### GEL Laboratories, LLC (A Member of The GEL Group, Inc.)

Charleston, SC | [www.gel.com](http://www.gel.com)  
Robert P. Wills | 843/556-8171 | [robert.wills@gel.com](mailto:robert.wills@gel.com)  
**Codes:** 37200, 93040\*

### GEM Technologies, Inc.

Knoxville, TN | <https://gemtechnologiesinc.com/>  
865/560-9434 | [bd@gemtechnologiesinc.com](mailto:bd@gemtechnologiesinc.com)  
**Codes:** 06790, 13050, 13850, 19280, 20300, 20350, 20700, 25400, 47400, 93040

### Genave

Hampton, MN | [www.genave.com](http://www.genave.com)  
Jim Edwards | 952/236-6540 | [support@genave.com](mailto:support@genave.com)  
**Codes:** 25300, 40900, 84600

### General Atomics Electromagnetic Systems

San Diego, CA | [www.ga.com/radiation-monitoring-systems](http://www.ga.com/radiation-monitoring-systems)  
Brandon Brooks | 858/964-6940 | [brandon.brooks@ga.com](mailto:brandon.brooks@ga.com)  
**Stamps:** ISO9001:015/AS9100:2016  
**Codes:** 03200, 03800, 09750, 09800, 12750, 12800, 14000, 17950, 19700, 25000, 26080, 42600, 47400, 55040, 55060, 67380, 68950, 69130, 69140, 69600, 70900, 70920, 74150\*

### General Magnaplate Corp.

Arlington, TX | [www.magnaplate.com](http://www.magnaplate.com)  
Darin Chase | 817/640-1761 | 800/852-3301 | [info@magnaplate.com](mailto:info@magnaplate.com)  
**Stamps:** ISO 9001:2015; AS9100D; Nadcap  
**Codes:** 11400, 14000, 17650, 46810, 47400, 49700

### General Plastics Mfg. Co.

Tacoma, WA | [www.generalplastics.com](http://www.generalplastics.com)  
Jaci Hendricks | 253/472-5000 | 800/806-6051 | [jaci\\_hendricks@generalplastics.com](mailto:jaci_hendricks@generalplastics.com)  
Lori Coker | 253/472-5000 | 800/806-6051 | [lori\\_coker@generalplastics.com](mailto:lori_coker@generalplastics.com)  
**Stamps:** General Plastics' quality system is certified to AS9100C and ISO 9001:2015/AS9100D, and meets requirements of NQA-1 and MIL-I-45208A  
**Codes:** 02870, 03800, 06860, 08800, 14300, 39960, 68000, 77800, 83210, 86130, 87000

### GenScope, Inc.

East Longmeadow, MA | [www.genscope.com](http://www.genscope.com)  
Sales | 413/526-0802 | [sales@genscope.com](mailto:sales@genscope.com)  
**Codes:** 26970, 39960, 73300

### Glenair, Inc.

Wallingford, CT | [www.glenair.com](http://www.glenair.com)  
Doug Merriman | 203/741-1115 | [dmerriman@glenair.com](mailto:dmerriman@glenair.com)  
**Codes:** 13400\*

### Glidewell Specialties Foundry Co.

Calera, AL | [www.glidewell-foundry.com](http://www.glidewell-foundry.com)  
Mark Fields | 937/287-1845 | [markfields@glidewell-foundry.com](mailto:markfields@glidewell-foundry.com)  
John Hendrix | 205/668-1881 x3011 | [jhendrix@glidewell-foundry.com](mailto:jhendrix@glidewell-foundry.com)  
**Stamps:** ISO 9000; Bureau Veritas Factory Approval Cert; Lloyd's Register Factory Approval.  
**Codes:** 14300, 49000, 56600, 77800, 91260, 91380, 92150

### Global Quality Management Advisors

Lynchburg, VA | [www.gqmadvisors.com](http://www.gqmadvisors.com)  
Paul W. Gladieux | 503/939-4498 | [paul@gqmadvisors.com](mailto:paul@gqmadvisors.com)  
**Codes:** 06860, 12800, 14000, 40900, 66200, 71190, 84600, 86300

### GLSEQ, LLC

Huntsville, AL | [www.glseq.com](http://www.glseq.com)  
Jim Gleason | 315/664-3771 | [jim.gleason@glseq.com](mailto:jim.gleason@glseq.com)  
Patrick Gleason | 256/369-8857 | [pat.gleason@glseq.com](mailto:pat.gleason@glseq.com)  
**Codes:** 03800, 04000, 06860, 12800, 12900, 14000, 14950, 17950, 20000, 21370, 24300, 25250, 32250, 54750, 55040, 56600, 58250, 66200, 69600, 71100, 74320, 76400, 77250, 82950, 84150, 84600, 86300

### GoldSim Technology Group

Seattle, WA | [www.goldsim.com](http://www.goldsim.com)  
Rick Kossik | 425/295-6985 | [rkossik@goldsim.com](mailto:rkossik@goldsim.com)  
**Codes:** 03800, 12800, 14000

### Goodway Technologies

Stamford, CT | <https://www.goodway.com/>  
Victor Crespo | 800/243-7932 x6373 | [vcrespo@goodway.com](mailto:vcrespo@goodway.com)  
Bill Griffin | 800/243-7932 x6326 | [wgriffin@goodway.com](mailto:wgriffin@goodway.com)  
**Codes:** 10780, 47400, 90100

### Gravis Technologies, Inc.

Wallace, ID | <https://gravistech.com/>  
Andrew Berg | 509/220-2625 | [drew@gravistech.com](mailto:drew@gravistech.com)  
**Stamps:** Certified Small Woman-Owned and HUBZone Business  
**Codes:** 12800, 14000, 39960, 40700, 57000, 64312\*

### Grecheck Consulting LLC

Midlothian, VA  
Eugene S. Grecheck | 804/382-2352 | [egrecheck@gmail.com](mailto:egrecheck@gmail.com)  
**Codes:** 14000, 62900, 62910, 70660, 70665

### GSE Engineering, Design & Analysis (Formerly known as DP Engineering)

Fort Worth, TX | <https://www.gses.com>  
Sunny DeMattio | 410/970-7800 | [sunny.demattio@gses.com](mailto:sunny.demattio@gses.com)  
Matthew Adams | 410/970-7898 | 407/739-2498 | [matt.adams@gses.com](mailto:matt.adams@gses.com)  
**Stamps:** EOC  
**Codes:** 03800, 06860, 13850, 14000, 28150\*

### GSE Engineering, Programs & Performance (Formerly known as True North Consulting)

Columbia, MD | [www.gses.com](http://www.gses.com)  
Derek Horn | 970/822-9213 | 970/252-1489 | [derek.horn@gses.com](mailto:derek.horn@gses.com)  
Sunny DeMattio | 410/970-7800 | [sunny.demattio@gses.com](mailto:sunny.demattio@gses.com)  
**Codes:** 14000\*



### GSE Engineering, Systems & Simulation (GSE Systems)

Columbia, MD | [www.gses.com](http://www.gses.com)  
 Gill Grady | 410/970-7803 | 443/745-5979 | [gill.grady@gses.com](mailto:gill.grady@gses.com)  
 Sunny DeMattio | 410/970-7800 | [sunny.demattio@gses.com](mailto:sunny.demattio@gses.com)  
**Codes:** 03800, 12800, 13850, 14000, 25700, 26080, 26100, 28150, 78400, 86300, 86400, 86500, 93040\*

### GSE Solutions (GSE Systems)

Columbia, MD | [www.gses.com](http://www.gses.com)  
 Sunny DeMattio | 410/970-7800 | [info@gses.com](mailto:info@gses.com)  
 Gill Grady | 410/970-7803 | 443/745-5979 | [gill.grady@gses.com](mailto:gill.grady@gses.com)  
**Codes:** 03800, 14000, 40900, 47400, 53950, 66200, 78400, 79000, 86300, 86500\*

### GSE Workforce Solutions, Technical Staffing (Formerly known as Absolute Consulting)

Columbia, MD | [gses.com/workforce-solutions/](http://gses.com/workforce-solutions/)  
 Sunny DeMattio | 410/970-7800 | [info@gses.com](mailto:info@gses.com)  
 Brian Greene | 410/970-7850 | [brian.greene@gses.com](mailto:brian.greene@gses.com)  
**Codes:** 25400\*

### GSE Workforce Solutions, Training Services (Formerly known as Hyperspring)

Columbia, MD | [gses.com/workforce-solutions/](http://gses.com/workforce-solutions/)  
 Russell E. (Rusty) Dunlap | 410/970-7842 | [russell.dunlap@gses.com](mailto:russell.dunlap@gses.com)  
 Sunny DeMattio | 410/970-7800 | [sunny.demattio@gses.com](mailto:sunny.demattio@gses.com)  
**Codes:** 12720, 12750, 12800, 14000, 25400, 56900, 71190, 86300, 86400, 86500\*

### GUTOR

Houston, TX | [www.gutor.com](http://www.gutor.com)  
 Mike May | 865/230-3582 | [michael.may@non.se.com](mailto:michael.may@non.se.com)  
**Stamps:** 10CFR50 App. B, ASME NQA-1, ISO 9001, ISO 14001, ISO 45001  
**Codes:** 07040, 07060, 07070, 07080, 24300, 41450, 63400

### H3D, Inc.

Ann Arbor, MI | [www.h3dgamma.com](http://www.h3dgamma.com)  
 Y. Andy Boucher | 734/661-6416 | [andy@h3dgamma.com](mailto:andy@h3dgamma.com)  
**Codes:** 12800, 17950, 20300, 25250, 39960, 55040, 56600, 68800, 77000

### Hansell Tierney, Inc. (WBE)

Mercer Island, WA | <https://hanselltierney.com/>  
 David Yount | 206/377-9840 | [dyount@hanselltierney.com](mailto:dyount@hanselltierney.com)  
**Stamps:** A certified women-owned business  
**Codes:** 14000, 25400

### Haption

New York, NY | [www.haption.com](http://www.haption.com)  
 John Dilworth | +33 243645120 | [john.dilworth@haption.com](mailto:john.dilworth@haption.com)  
**Codes:** 72300

### Hayward Tyler Inc.

Colchester, VT | [www.haywardtyler.com](http://www.haywardtyler.com)  
 Jeff Belotti | 802/655-4444 | [jeffrey.belotti@haywardtyler.com](mailto:jeffrey.belotti@haywardtyler.com)  
**Stamps:** N, NA, NPT, and NS, and U Classes 1, 2 & 3.  
**Codes:** 03800, 55300, 64700\*

### Health Physics Instruments (Div. of Far West Technology)

Goleta, CA | [www.fwt.com](http://www.fwt.com)  
 John Handloser | [info@fwt.com](mailto:info@fwt.com)  
**Codes:** 03200, 17950, 21270, 37130, 37200, 47400, 55040, 69600

### Heat Exchanger Products Corp. (HEPCO)

Hingham, MA | [www.heatexchangerproducts.com](http://www.heatexchangerproducts.com)  
 Tracy Hennigan Bonnyman | 781/749-0220 | [hepco@heatexchangerproducts.com](mailto:hepco@heatexchangerproducts.com)  
**Stamps:** Woman Owned Small Business Cert. #W020010  
**Codes:** 10780, 20350, 37600, 47400, 61570, 80730, 84150\*

### Hennigan Engineering LLC

Hingham, MA | [www.henniganengineering.com](http://www.henniganengineering.com)  
 Tracy Hennigan Bonnyman | 781/749-0220 | 800/472-8484  
[thb@henniganengineering.com](mailto:thb@henniganengineering.com)  
**Stamps:** Certification by SSPC-QP1 and QP2.  
**Codes:** 10780, 11400, 13200, 20300, 20350, 37600, 40900, 47400, 56600, 61570, 80730, 84600

### Hexion Inc.

Columbus, OH | [www.hexion.com](http://www.hexion.com)  
 Product Information | 614/225-4000 | 800/443-9466 | [service@hexion.com](mailto:service@hexion.com)  
**Codes:** 02870, 11400, 14000, 17650

### HGP Inc.

Greenville, SC | [www.hgp-inc.com](http://www.hgp-inc.com)  
 Fred Giffels | 864/370-0213 | [fgiffels@hgp-inc.com](mailto:fgiffels@hgp-inc.com)  
**Codes:** 12750, 12800, 14000

### HI-Q Environmental Products Co., Inc.

See advertisement on page 102  
 San Diego, CA | [www.HI-Q.net](http://www.HI-Q.net)  
 Marc A. Held | 858/549-2820 | [info@hi-q.net](mailto:info@hi-q.net)  
**Stamps:** Quality Management System is both ISO 9001:2015 and ISO 17025:2017 Certified for the manufacturing of Air Sampling & Radiation Monitoring Equipment, Systems & Accessories along with ANSI N13.1-2011 - 2021 Stack Sampling Location Qualification Testing for plant vent stack radiation monitoring systems.  
**Codes:** 03200, 04000, 09750, 09800, 09900, 17950, 21270, 25250, 26080, 26100, 27450, 37130, 37200, 41000, 51850, 55040, 55060, 58000, 64750, 69600, 74150, 74320, 84150, 90100, 90800\*

### Highland TEMS, LLC

Marietta, GA | [www.highland-temsengineering.com](http://www.highland-temsengineering.com)  
 Ralph Schwartzbeck, P.E. | 404/386-3971 | [ralph@highland-temsengineering.com](mailto:ralph@highland-temsengineering.com)  
**Codes:** 14000

### Holtec International

See advertisement on page 109  
 Camden, NJ | [www.holtecinternational.com](http://www.holtecinternational.com)  
 Joy Russell | 856/797-0900 x3655 | [j.russell@holtec.com](mailto:j.russell@holtec.com)  
**Stamps:** ISO 9001:2008, ASME Stamps: N, NPT, N3, U, R, NR, NB, NS.  
**Codes:** 03800, 13180, 13200, 14000, 14300, 30500, 37600, 38000, 47400, 66280, 68000, 77750, 77800, 81680, 81710, 92300, 93040

### Hopewell Designs, Inc.

Alpharetta, GA | [www.hopewelldesigns.com](http://www.hopewelldesigns.com)  
 Richard Warren | 770/667-5770 | [richard.warren@hopewelldesigns.com](mailto:richard.warren@hopewelldesigns.com)  
 Kevin Klem | 770/667-5770 | [sales@hopewelldesigns.com](mailto:sales@hopewelldesigns.com)  
**Codes:** 00400, 09750, 09800, 14300, 20300, 37130, 37160, 37200, 42800, 47400, 49000, 50250, 55490, 68000, 73300, 73900, 77750, 77800, 86000, 86800

### Hot Cell Services Corp. (HCS Corp.)

Kent, WA | [www.hotcell.com](http://www.hotcell.com)  
 Michael Clayton | 253/409-6376 | 253/854-4945 | [claytonm@corning.com](mailto:claytonm@corning.com)  
 Zbigniew Tomalik | 253/854-4945 | 253/350-4362 | [tomalikz@corning.com](mailto:tomalikz@corning.com)  
**Stamps:** ASME NQA-1  
**Codes:** 03800, 14000, 22800, 39300, 39400, 47400, 48050, 72300, 73300, 75190, 77750, 77800, 95750\*



# Directory of Suppliers

HUK-ISO

## HukariAscendent

Wheat Ridge, CO | [www.hukari.com](http://www.hukari.com)

**Codes:** 12720, 12750, 12800, 13850, 14000, 71190, 86300

## Human Resources Consulting

Gallatin, TN | [www.yourhrconsultant.com](http://www.yourhrconsultant.com)

Gary Kaufman | 615/305-1900 | [garykaufman@yourhrconsultant.com](mailto:garykaufman@yourhrconsultant.com)

**Codes:** 25400, 86300

## Huhtable Consulting LLC

Hilton Head, SC | <https://www.huhtableconsulting.com/>

Brian Huhtable | 651/399-0832 | [brian@huhtableconsulting.com](mailto:brian@huhtableconsulting.com)

**Codes:** 12800

## Hybrid Power Technologies LLC

Overland Park, KS | <http://hybridpowertechnologies.online/>

Michael Keller | 913/375-6983 | [m.keller@hybridpwr.com](mailto:m.keller@hybridpwr.com)

**Codes:** 56900, 62900, 62910, 70660, 70665, 89500, 92300

## Hydro, Inc. (HydroAire Services Division)

Chicago, IL | [www.hydroinc.com](http://www.hydroinc.com)

Faisal Salman | 312/738-3000 | 800/223-7867 | [fsalman@hydroinc.com](mailto:fsalman@hydroinc.com)

**Stamps:** HydroAire's N-Stamp (N-3352) and National Board of Boiler and Pressure Vessel Inspectors, Certificate of Authorization (NR-92) for Nuclear Repairs were renewed July 2021. They are authorized by ASME to provide services for code pumps. HydroAire also holds an ASME NPT Certificate (N-3194). Their QA Program complies with 10CFR50 App. B, ASME Section III and applicable sections of ASME Section XI. The program has been audited by NUPIC- Audit 23510. They are on a 3-year Survey cycle.

**Codes:** 03800, 12750, 14000, 40900, 46200, 46950, 47400, 56600, 64700, 64750, 84150, 84600

## I.C.E. Service Group, Inc.

See advertisement on page 117

Moon Township, PA | [www.iceservicegroup.com](http://www.iceservicegroup.com)

Dennis Morgan, II | 412/916-5710 | [dmorgan@iceservicegroup.com](mailto:dmorgan@iceservicegroup.com)

**Stamps:** NQA-1

**Codes:** 09950, 12800, 14000, 14300, 20250, 20300, 25250, 25400, 26230, 49000, 50250, 68000, 86300, 87000, 93040, 93240

## Idaho National Laboratory

Idaho Falls, ID | [www.inl.gov](http://www.inl.gov)

Joel Hiller | 208/526-7785 | [joel.hiller@inl.gov](mailto:joel.hiller@inl.gov)

**Codes:** 03800, 40700, 70600, 75600, 84430, 84600

## ILD, Inc.

Baton Rouge, LA | [www.ildpower.com](http://www.ildpower.com)

Jack Little | 225/769-2780 x111 | [jack@ildpower.com](mailto:jack@ildpower.com)

Eugene Chiarulli | 225/769-2780 x118 | [eugene2@ildpower.com](mailto:eugene2@ildpower.com)

**Codes:** 03800, 14000, 84600, 86300

## Imperia Engineering Partners LLC

Milford, MA | [www.imperiaep.com](http://www.imperiaep.com)

Scot Blodgett | 508/259-9142 | [scot.blodgett@imperiaep.com](mailto:scot.blodgett@imperiaep.com)

**Codes:** 03800, 12750, 13850, 14000, 20300, 40900, 75600, 80800, 84600

## In-Place Machining Company, LLC

Blue Ash, OH | [www.inplace.com](http://www.inplace.com)

Joe Shebesta | 513/388-0199 | [jshebesta@inplace.com](mailto:jshebesta@inplace.com)

**Codes:** 12750, 13050, 13850, 14000, 20300, 20700, 40900, 46950, 47400, 49000, 56600, 86130, 93900

## Incap Electronics US, Inc.

California, PA | [www.incapcorp.com](http://www.incapcorp.com)

Dave Spehar | 724/938-1800 | [info@pennatronics.com](mailto:info@pennatronics.com)

**Stamps:** 10CFR50 App. B Program; ISO9001:2015; ISO13485:2016, ESD S20.20

**Codes:** 15200, 24300, 69600

## Inert Corp.

Amesbury, MA | <https://www.inertcorp.com/>

Sales Department | 978/462-4415 | [sales@inerttechnology.com](mailto:sales@inerttechnology.com)

**Codes:** 04000, 13400, 32250, 36000\*

## InfoTech NorthStar

Richland, WA | [infotechnorthstar.com](http://infotechnorthstar.com)

Nolan Wright | [nolan.wright@infotechnorthstar.com](mailto:nolan.wright@infotechnorthstar.com)

**Codes:** 12750, 12800, 14000, 28150, 37200, 86300

## Interdevelopment, Inc.

Falls Church, VA | [www.interdevelopment.com](http://www.interdevelopment.com)

M.K. Luddemann-Faris | 202/508-1459 | [interdevelopment@starpower.net](mailto:interdevelopment@starpower.net)

**Codes:** 03800, 14000, 86900

## International Isotopes, Inc. (RadQual)

Idaho Falls, ID | [www.intisoid.com](http://www.intisoid.com)

Terri Snarr | 208/524-5300 | [tsnarr@intisoid.com](mailto:tsnarr@intisoid.com)

Shahe Bagerdjian | 208/524-5300 | [sbagerdjian@intisoid.com](mailto:sbagerdjian@intisoid.com)

**Codes:** 25600, 40900, 68950\*

## Intertek

Santa Clara, CA | [intertek.com/nuclear](http://intertek.com/nuclear)

Russell Cipolla | 408/636-5322 | [russell.cipolla@intertek.com](mailto:russell.cipolla@intertek.com)

**Codes:** 03800, 14000, 56600

## Intralox

New Orleans, LA | [www.hydrolox.com](http://www.hydrolox.com)

Tim Woodrow | 504/733-0463 | 888/417-2358 | [tim.woodrow@intralox.com](mailto:tim.woodrow@intralox.com)

**Codes:** 93220

## InVizion LLC

Oak Ridge, TN

Kristy Neckowicz | 484/270-0239 | [info@invizionllc.com](mailto:info@invizionllc.com)

**Codes:** 12750, 12800, 14000, 86300

## IONEX Research Corp.

Lafayette, CO | [www.ionex.us](http://www.ionex.us)

David Pease | 303/666-5550 | [dpease@ionex.us](mailto:dpease@ionex.us)

**Stamps:** U, R, QA System per ASME NQA-1

**Codes:** 03000, 09900, 19450, 27180, 27250, 27450, 32250, 37130, 92300

## ISO-PACIFIC Remediation Technologies, Inc.

Richland, WA | [www.isopacific.net](http://www.isopacific.net)

Lori Dillon | 509/375-0100 | [admin@isopacific.net](mailto:admin@isopacific.net)

**Codes:** 03200, 03800, 09730, 10780, 12800, 14000, 17950, 18600, 20300, 21370, 22700, 25600, 26230, 30500, 37130, 37200, 39960, 47400, 53950, 56600, 63400, 64700, 66280, 67380, 68950, 71190, 72300, 73300, 74150, 74320, 77750, 79700, 87400, 93040



### Jacobs (CH2M HILL Nuclear Business Group), (CH2M HILL International Nuclear Services, Ltd.), (CH2M HILL Constructors, Inc.), (Jacobs Engineering), (Jacobs)

Dallas, TX | [www.jacobs.com](http://www.jacobs.com)

Amel Korjenic | [amel.korjenic@jacobs.com](mailto:amel.korjenic@jacobs.com)

Jennifer Sen | 919/760-7035 | [jennifer.sen@jacobs.com](mailto:jennifer.sen@jacobs.com)

**Stamps:** American Society of Mechanical Engineers Nuclear Quality Assurance (ASME) NQA-1

**Codes:** 14000, 20300, 20700, 93040

### James C. White Company, Inc.

See advertisement on page 118

Greenville, SC | [www.jcwco.com](http://www.jcwco.com)

John A. White | 864/288-4692 | 800/421-9410 | [nuclearsales@jcwco.com](mailto:nuclearsales@jcwco.com)

**Codes:** 03000, 07800, 08800, 09100, 46950, 49000, 50250, 60100, 71500, 87140, 88200\*

### James Fisher Technologies

Loveland, CO | [www.jftechgroup.com](http://www.jftechgroup.com)

Scott Adams | 720/408-0100 | [scott.adams@jftechgroup.com](mailto:scott.adams@jftechgroup.com)

**Stamps:** NQA-1 Quality Assurance Program, ASME U & R Stamps, ISO 9001:2015

**Codes:** 03000, 03200, 03800, 04000, 07370, 08100, 08800, 09750, 09800, 10780, 10850, 12800, 13050, 13400, 14000, 17950, 20300, 20350, 20700, 25400, 26230, 26500, 26910, 30500, 36000, 36820, 37130, 39650, 40900, 44090, 45550, 46950, 47400, 47600, 48050, 48300, 53950, 55040, 55060, 56600, 59850, 67380, 68000, 70650, 72300, 73300, 73550, 73620, 79360, 84150, 86130, 92800, 93040

### Jensen Hughes

Baltimore, MD | [www.jensenhughes.com](http://www.jensenhughes.com)

Hunter Young | 623/738-3873 | [hyoung@jensenhughes.com](mailto:hyoung@jensenhughes.com)

Don Vanover | 484/260-6952 | [dvanover@jensenhughes.com](mailto:dvanover@jensenhughes.com)

**Codes:** 12800, 14000, 20300, 28150, 75600, 86300

### JETSEAL, Inc.

Spokane Valley, WA | <https://jetseal.com/nuclear/>

Kingston Vickers | 509/998-7756 | [kingston.vickers@jetseal.com](mailto:kingston.vickers@jetseal.com)

**Stamps:** AS9100, NADCAP

**Codes:** 20350, 75190\*

### JME Technologies

Crystal Lake, IL | [www.jmetechnologies.com](http://www.jmetechnologies.com)

Karen Ewert | 815/477-8800 | [kewert@jmetechnologies.com](mailto:kewert@jmetechnologies.com)

**Codes:** 40900, 56600

### JNT Technical Services Inc.

Little Ferry, NJ | [www.torq-n-seal.com](http://www.torq-n-seal.com)

Glenn Jorgensen | 201/641-2130 | [sales@jnttechnical.com](mailto:sales@jnttechnical.com)

**Stamps:** NPT N-2928, Class III: NCA 3800, 10CFR50 App. B/10CFR Part 21.

**Codes:** 24300, 47400, 56600, 61570, 70650, 86130

### Joseph Oat Corp.

Camden, NJ | [www.josephoat.com](http://www.josephoat.com)

John McDonald | 856/541-2900 | [j.mcdonald@josephoat.com](mailto:j.mcdonald@josephoat.com)

Cliff DeCoursey | 856/541-2900 | [sales@josephoat.com](mailto:sales@josephoat.com)

**Stamps:** N, NPT, NA, NS, Classes 1, 2, 3, MC, U, S; N Classes 1, 2, 3, MC Vessels + Piping Sys. +2, 3 Storage Tanks, NPT Class 1, 2, 3 & MC, NA Class 1, 2, 3 U&S, Certification by ISO 9001.

**Codes:** 00400, 03800, 07200, 07330, 09950, 11600, 13200, 13220, 13700, 14000, 14300, 20500, 21200, 22800, 26900, 27450, 28400, 28530, 28550, 31700, 33360, 36000, 36870, 37600, 38000, 40900, 49000, 50300, 50350, 51850, 56600, 56750, 56900, 57050, 58250, 59800, 59820, 60900, 64320, 66280, 68000, 77700, 77750, 78700, 79200, 81710, 81790, 82250, 82800, 83150, 84600, 86750, 87950, 88000, 88100, 90100, 92150, 92300, 93500, 93900

### JRM Chemical Inc.

Cleveland, OH | [www.soilmoist.com](http://www.soilmoist.com)

Scott Wiesler | 216/475-8488 | 800/962-4010 | [jrm@en.com](mailto:jrm@en.com)

**Codes:** 79370

### JSM Protective, Inc.

Port St. Lucie, FL | [www.jsmprotective.com](http://www.jsmprotective.com)

Jeannette S. McLean | 910/619-3141 | [jmclean@jsmonline.com](mailto:jmclean@jsmonline.com)

**Stamps:** Woman Owned Small Business; ANS Member; SAM Registered

**Codes:** 10850, 10900, 23900, 26080, 26600, 27180, 27450, 29360, 36000, 37130, 37160, 38440, 41200, 47200, 47630, 47670, 54750, 55040, 64300, 72300, 73550, 75000, 75010, 77800, 79370, 83110, 83120, 83150, 83210, 95750, 95850

### K-Tek International Inc.

Wilsonville, OR | [www.ktekintl.com](http://www.ktekintl.com)

James Shim | 503/624-0315 | [james@ktekintl.com](mailto:james@ktekintl.com)

**Codes:** 40900, 47400, 60150, 75850, 91260, 91380, 92300

### KCI Engineering Consultants

Downers Grove, IL | <https://www.kciconsultants.com/>

Jim Raines | 630/956-0519 | [jraines@kciconsultants.com](mailto:jraines@kciconsultants.com)

**Codes:** 03800, 12800, 13850, 14000, 20300, 23850, 40900, 46200, 47400, 54750, 86300

### Kiewit Nuclear Solutions Co.

See advertisement on page 59

Oak Ridge, TN | <https://www.kiewit.com/>

Josh Patterson | 865/364-8252 | [joshua.patterson@kiewit.com](mailto:joshua.patterson@kiewit.com)

Tessa Maffett | 713/899-0953 | [tessa.maffett@kiewit.com](mailto:tessa.maffett@kiewit.com)

**Codes:** 13850

### Kinematics, Inc.

Pasadena, CA | [www.kinematics.com](http://www.kinematics.com)

Mauricio Ciudad-Real | 626/795-2220 | [mcr@kmi.com](mailto:mcr@kmi.com)

**Codes:** 03800, 09800, 14000, 76400, 84600, 86300

### Klein Consulting LLC

Norwich, CT | [www.kleinconsultllc.com](http://www.kleinconsultllc.com)

Ralph L. Klein | 860/885-1980 | [ralph.klein@kleinconsultllc.com](mailto:ralph.klein@kleinconsultllc.com)

**Codes:** 06860, 14000, 40900, 66200, 86300

### Knowledge Relay

Cypress, CA | [www.knowledgerelay.com](http://www.knowledgerelay.com)

Lee Gliddon | 714/761-6760 | [lee.gliddon@knowledgerelay.com](mailto:lee.gliddon@knowledgerelay.com)

Mariya Skoblov | 714/761-6760 | [mskoblov@knowledgerelay.com](mailto:mskoblov@knowledgerelay.com)

**Codes:** 12750, 12800, 14000, 19700\*

### Komline

Peapack, NJ | [www.komline.com](http://www.komline.com)

Brian Komline | 908/234-1000 | [info@komline.com](mailto:info@komline.com)

**Stamps:** ASME

**Codes:** 09730, 22410, 24170, 68000, 93040

### Konecranes Nuclear Equipment & Services LLC (Formerly Morris Material Handling / P&H)

New Berlin, WI | [www.konecranes.com](http://www.konecranes.com)

Steve Lawrence | 262/364-5700 | [steve.lawrence@konecranes.com](mailto:steve.lawrence@konecranes.com)

**Stamps:** 10CFR50 Appendix B, NQA-1, ISO 9001 compliant.

**Codes:** 09950, 18600, 30500, 40900, 47400, 72300, 81680, 81710, 87000, 96200



# Directory of Suppliers

KSB-MAC

## KSB, Inc.

Henrico, VA | [www.ksb.com](http://www.ksb.com)

Loyal Fischer | 330/239-3900 | [loyal.fischer@ksb.com](mailto:loyal.fischer@ksb.com)

**Stamps:** N, NPT, NS, Classes 1, 2, 3, TUV-Pfalz e.V:AD-HPO, TRD 201, TRR 100, DIN EN 729-2; KTA 1408.3, KTA 3201.3; TUV Cert. DIN EN ISO 9001, SLV: DIN 18800 T7; VGB:KTA 1401.

**Codes:** 10010, 47400, 64480, 64700, 64750, 75190, 89510, 90250, 90280, 90330, 90600, 91000, 91260, 91380

## LabLogic Systems, Inc.

Chantilly, VA | [www.lablogic.com](http://www.lablogic.com)

Ashvin Boodhun | 703/429-4209 | 917/225-0651 | [aboodhun@lablogic.com](mailto:aboodhun@lablogic.com)

Mirna Ayshoa | 703/429-4209 | [mayshoa@lablogic.com](mailto:mayshoa@lablogic.com)

**Codes:** 03200, 03800, 04000, 09800, 17950, 25250, 55040

## Laboratory Services (Div. of Consumers Energy)

Jackson, MI | [www.laboratoryservices.com](http://www.laboratoryservices.com)

Merideth Armstrong | 517/788-2218 | 800/736-4147  
[merideth.armstrong@cmsenergy.com](mailto:merideth.armstrong@cmsenergy.com)

**Stamps:** 10CFR50 App. B, ANSI/NCSL Z540, ISO/IEC 17025 General Requirements for the Competence of Testing and Calibration Laboratories Certification by A2LA - American Association For Laboratory Accreditation

**Codes:** 03800, 09800, 40900, 41000, 56600, 68900

## Lambda Technologies (Surface Enhancement Technologies, LLC and Lambda Research, Inc.)

Cincinnati, OH | [www.lambdatechs.com](http://www.lambdatechs.com)

Julie Prevey | 513/561-0883 | 800/883-0851 | [jprevey@lambdatechs.com](mailto:jprevey@lambdatechs.com)

**Codes:** 03800, 17650, 44000, 56600, 70650, 82200, 84600

## Lancs Industries

Albuquerque, NM | [www.lancsindustries.com](http://www.lancsindustries.com)

Lewis E. Byrd | 505/738-7200 | [info@lancsindustries.com](mailto:info@lancsindustries.com)

**Stamps:** Certification by SEG.

**Codes:** 03000, 10850, 10900, 14300, 26550, 27450, 36000, 37130, 50250, 64300, 64750, 68000, 73550, 77800, 83210

## Landstar

Burlington, KY | [www.bbtransportation.com](http://www.bbtransportation.com)

Brandon Coburn | 859/525-7120 | 800/872-9625 | [brandon.coburn@landstarmail.com](mailto:brandon.coburn@landstarmail.com)

**Codes:** 14300, 87000\*

## LATA

Albuquerque, NM | [www.lata.com](http://www.lata.com)

Robin Beard | 806/381-3114 | [rbeard@lata.com](mailto:rbeard@lata.com)

**Codes:** 03800, 06860, 13850, 14000, 20300, 20700

## Leak Testing Specialists, Inc.

Orlando, FL | [leaktestingspecialists.com](http://leaktestingspecialists.com)

Jose Pizzi | 407/737-6415 | [jose.pizzi@leaktestingspec.com](mailto:jose.pizzi@leaktestingspec.com)

**Codes:** 13850, 14000, 14300, 84150, 84600, 86300, 86400

## LeBlond and Associates, LLC

Libertyville, IL | [www.leblondassociates.com](http://www.leblondassociates.com)

Peter LeBlond | 847/549-8775 | [leblond@prodigy.net](mailto:leblond@prodigy.net)

**Codes:** 14000, 86300, 86500

## Lenox Instrument Co., Inc.

Trevese, PA | [www.lenoxinst.com](http://www.lenoxinst.com)

Bill Lang | 215/322-9990 | 800/356-1104 | [sales@lenoxinst.com](mailto:sales@lenoxinst.com)

**Codes:** 26230, 40900, 73300, 83600, 92800

## Lightbridge Corporation

Reston, VA | [www.ltbridge.com](http://www.ltbridge.com)

James Fornof | 571/730-1200 | [jfornof@ltbridge.com](mailto:jfornof@ltbridge.com)

Seth Grae | 571/730-1200 | [sgrae@ltbridge.com](mailto:sgrae@ltbridge.com)

**Codes:** 14000

## Lights Camera Action, LLC

Gilbert, AZ | [www.lights-camera-action.net](http://www.lights-camera-action.net)

Walt Ahland | 480/345-0642 | [wahland@lights-camera-action.net](mailto:wahland@lights-camera-action.net)

**Codes:** 45550, 48950, 50300

## Lincoln Structural Solutions

Louisville, NE | [www.lincolnstructural.com](http://www.lincolnstructural.com)

Danielle Kottas | 402/952-4401 | 800/571-6884 | [dkottas@lincolnstructural.com](mailto:dkottas@lincolnstructural.com)

**Codes:** 07330, 07340, 07800, 13700, 15600, 16000, 17200, 18400, 26900, 28400, 28410, 28530, 28550, 46950, 49000, 50350, 59800, 60100, 78700, 79000, 82250, 82310, 84600, 87950, 88000, 88100, 88200

## LND, Inc.

See advertisement on pages 66 and 89

Oceanside, NY | [www.lndinc.com](http://www.lndinc.com)

Bill Lehnert | 516/678-6141 | [info@lndinc.com](mailto:info@lndinc.com)

**Codes:** 01300, 04000, 17950, 21270, 25000, 26080, 28300, 37130, 51850, 54750, 55040, 55060, 55200, 56400, 69600, 74150, 87900, 93040, 95300

## Lockton Insurance

Houston, TX | [www.lockton.com](http://www.lockton.com)

Brian Lavezzari | 832/267-7199 | 713/458-5352 | [brian.lavezzari@lockton.com](mailto:brian.lavezzari@lockton.com)

**Codes:** 03800

## Longenecker & Associates, Inc.

Las Vegas, NV | [www.la-inc.com](http://www.la-inc.com)

Mike Nartker | 202/957-8137 | [mnartker@la-inc.com](mailto:mnartker@la-inc.com)

**Codes:** 12800, 13850, 14000, 20300, 87000, 93040

## Lucideon

Schenectady, NY | [www.lucideon.com/nuclear](http://www.lucideon.com/nuclear)

Dan Cunningham | 919/504-2000 | 814/933-2897 | [dan.cunningham@us.lucideon.com](mailto:dan.cunningham@us.lucideon.com)

**Stamps:** ISO/IEC 17025, Nadcap AC7101 - Materials Testing and 10CFR50 App. B

**Codes:** 03800, 14000, 25600, 46950, 84600, 93040

## Ludlum Measurements, Inc.

Sweetwater, TX | <https://ludlums.com>

Allan Hartfield | 325/235-5494 | 800/622-0828 | [ahartfield@ludlums.com](mailto:ahartfield@ludlums.com)

**Codes:** 04000, 17950, 21270, 37130, 55040, 55060, 69130, 74400, 75010, 87380\*

## M. Braun, Inc.

Stratham, NH | [www.mbraun.com](http://www.mbraun.com)

Michael Boutin | 603/773-9333 | [m.boutin@mbraunusa.com](mailto:m.boutin@mbraunusa.com)

**Codes:** 04000, 12750, 32250, 36000, 37130, 39300

## M2 Polymer Technologies, Inc.

West Dundee, IL | [www.m2polymer.com](http://www.m2polymer.com)

Martin Matushek | 847/836-1393 | [info@m2polymer.com](mailto:info@m2polymer.com)

**Codes:** 20350, 68000, 79360, 79370

## The Macris Group

Mystic, CT | [www.themacrisgroup.com](http://www.themacrisgroup.com)

A. C. (Dean) Macris | 860/572-0043 | [acmpc@acmacris.com](mailto:acmpc@acmacris.com)

**Codes:** 14000





### Magnatech LLC

East Granby, CT | [www.magnatechllc.com](http://www.magnatechllc.com)

John Emmerson | 860/653-2573 | [info@magnatechllc.com](mailto:info@magnatechllc.com)

**Codes:** 59850, 83600, 93750, 93800, 93900

### Major Tool & Machine (A Precinmac Company)

See advertisements on pages 13 and 73

Indianapolis, IN | [www.majortool.com](http://www.majortool.com)

J. David Weyreter | 317/917-4062 | [dweyreter@precinmac.com](mailto:dweyreter@precinmac.com)

**Stamps:** N Class 1, 2, 3 & MC Vessels; Class 1, 2 & 3 Piping Systems; Class 2 & 3 Storage Tanks, Class CS Core Support Structures, Class TP Transport Packaging, Class TC Transportation Containments and Class SC Storage Containments; NPT Class 1, 2, 3, CS, MC, TP. ASME NQA-1 2008 w/2009 addenda ASME U, U2, R

**Codes:** 10010, 14300, 14810, 17200, 28300, 30500, 31700, 36000, 37600, 44080, 46950, 49000, 56600, 66280, 77700, 79740, 81710, 82250, 83150, 87380, 87395, 90100, 92150, 92300, 93900

### Manafort Brothers Inc.

Plainville, CT | [www.manafort.com](http://www.manafort.com)

Vince Mondo | 860/793-6451 | [vmondo@manafort.com](mailto:vmondo@manafort.com)

**Codes:** 13850, 20300, 20700

### Marshallton Research Laboratories, Inc.

King, NC | [www.marshalltonlabs.com](http://www.marshalltonlabs.com)

Mac Foster | 336/983-2131 | [info@marshalltonlabs.com](mailto:info@marshalltonlabs.com)

**Codes:** 20350

### Martek Instruments, Inc.

Raleigh, NC | [www.martekinstruments.com](http://www.martekinstruments.com)

David Zabarsky | 919/790-2371 | 800/628-8834 | [info@martekinstruments.com](mailto:info@martekinstruments.com)

**Codes:** 04000, 51850, 54750

### Master-Lee Energy Services

Latrobe, PA | [www.masterlee.com](http://www.masterlee.com)

Michael Hamby | 724/805-4913 | 800/662-4493 | [hamby-mt@masterlee.com](mailto:hamby-mt@masterlee.com)

**Codes:** 47400\*

### Master-Lee Engineered Products Inc.

Latrobe, PA | [www.masterlee.com](http://www.masterlee.com)

Ki Park | 724/805-4925 | 800/537-6007 | [park-kd@masterlee.com](mailto:park-kd@masterlee.com)

**Codes:** 10780, 26230, 30500, 45550, 47400, 47600, 61570, 70650, 72300, 84600, 86130, 90100, 92800

### Materials and Chemistry Laboratory, Inc. (MCLinc)

Oak Ridge, TN | [www.mcl-inc.com](http://www.mcl-inc.com)

Barry Stephenson | 865/276-6910 | [bstephenson@mcl-inc.com](mailto:bstephenson@mcl-inc.com)

Brian Havelly | 865/276-6914 | [bhavelly@mcl-inc.com](mailto:bhavelly@mcl-inc.com)

**Stamps:** AIHA; ISO/IEC 17025-2005; DOECAP - AP

**Codes:** 03800, 14000, 37200, 84600

### Maxeta Technologies, Inc.

Skillman, NJ | [www.maxetatech.com](http://www.maxetatech.com)

[info@maxetatech.com](mailto:info@maxetatech.com) | 877/9-MAXETA

**Codes:** 12800

### Mazur Instruments

Castle Rock, CO | [www.mazurinstruments.com](http://www.mazurinstruments.com)

Vince Mazur | 303/325-7463 | [vince.mazur@mazurinstruments.com](mailto:vince.mazur@mazurinstruments.com)

**Codes:** 17950

### Mechanical Solutions, Inc.

Whippany, NJ | [www.mechsol.com](http://www.mechsol.com)

Maki M. Onari | 973/326-9920 x117 | [maki.onari@mechsol.com](mailto:maki.onari@mechsol.com)

**Stamps:** ISO TC108 Voting Member, ISO Cat IV, Vibration Institute Corp. Member, Hydraulic Institute Standards Partner

**Codes:** 03000, 03800, 09875, 14000, 47400, 54750, 84150, 84600, 86300\*

### Mega-Tech Services, LLC

Cooksburg, PA | [www.mega-techservices.biz](http://www.mega-techservices.biz)

John W. Bowen | 804/789-1577 | [jbowen@mega-techservices.biz](mailto:jbowen@mega-techservices.biz)

**Codes:** 03800, 13050, 14000, 20300, 20350, 81710, 86130

### Meridian Services Group (formerly Work Management, Inc., and High Bridge Associates, Inc.)

Chattanooga, TN | <https://meridian-sg.com/>

Liz Snow | 423/468-4317

Jim O'Connor | 423/468-4317

**Codes:** 03800, 14000, 20300, 86300\*

### Merrick & Company

Greenwood Village, CO | [www.merrick.com/nuclear](http://www.merrick.com/nuclear)

Tony Wampler | 719/322-6220 | 800/544-1714 | [tony.wampler@merrick.com](mailto:tony.wampler@merrick.com)

**Stamps:** Engineering, design, fabrication management and commissioning of specialized nuclear service equipment, systems, and facilities; 3D High Definition scanning and mapping. Nuclear quality program.

**Codes:** 12750, 13850, 14000, 20300, 22800, 23850, 25400, 26500, 27150, 30500, 31700, 32250, 38600, 39400, 39960, 44000, 46200, 47600, 47620, 53950, 58250, 58800, 60900, 62200, 68000, 70650, 72300, 73350, 73620, 75600, 79200, 80600, 86130, 87380, 87395, 87400, 93040, 95750

### The Merrick Group, Inc.

West Hazleton, PA | [www.merrickgroupinc.com](http://www.merrickgroupinc.com)

Christopher J. Speas | 602/885-3350 | [cspeas@mginc.net](mailto:cspeas@mginc.net)

**Stamps:** QA Program - NUPIC

**Codes:** 47400, 56600

### MillenniTEK, LLC

Knoxville, TN | [www.millennitek.com](http://www.millennitek.com)

Steve Getley | 865/966-2170 | [steve.getley@millennitek.com](mailto:steve.getley@millennitek.com)

**Codes:** 01300, 03800, 10100, 12750, 13700, 14000, 16000, 24300, 31600, 41100, 41200, 43400, 46950, 55490, 77800

### Millspaw Electronics

Mason, OH | [www.millspawelectronics.com](http://www.millspawelectronics.com)

Leigh Skorupskas | 773/329-1846 | [leigh@millspawelectronics.com](mailto:leigh@millspawelectronics.com)

Sam Millspaw | 412/736-8241 | [sam@millspawelectronics.com](mailto:sam@millspawelectronics.com)

**Stamps:** 10CFR50 App. B QA Program

**Codes:** 12900, 14000

### Mirion Technologies (Canberra) Inc.

Meriden, CT | [www.mirion.com](http://www.mirion.com)

203/238-2351 | 800/243-3955 | [customersupport@mirion.com](mailto:customersupport@mirion.com)

**Stamps:** Certification by ISO 9001.

**Codes:** 06820, 09750, 09800, 12800, 12900, 14000, 14950, 15200, 17950, 19700, 20000, 20300, 20350, 21270, 21310, 25000, 25250, 26080, 26100, 26230, 34800, 35650, 37130, 37200, 40900, 41000, 44000, 47400, 55040, 55060, 55200, 56400, 56470, 58000, 63800, 66200, 67380, 68000, 68800, 68950, 69130, 69140, 69600, 71190, 73450, 73770, 73900, 74150, 74400, 77750, 79850, 84150, 84600, 86300, 93040\*



# Directory of Suppliers

## MIR-NEW

### Mirion Technologies (IST) Corp. (Sensing Systems Div.)

See advertisement on page 91

Horseheads, NY | [www.mirion.com](http://www.mirion.com)

Tim Pelot | 607/562-4530 | [tpelot@mirion.com](mailto:tpelot@mirion.com)

**Stamps:** N Classes 1, 2, 3 & MC Vessels, Class 1, 2, 3 Valve Parts & Appurt., Class 1, 2, 3, Valves, Class MC Penetrations & Assem.

**Codes:** 08800, 09100, 13400, 14950, 17950, 21270, 22150, 25000, 26910, 26970, 28300, 28550, 40900, 45550, 47400, 54750, 56400, 56750, 58250, 62200, 63800, 69600, 70650, 73300, 75190, 77250, 79740, 83600, 84150, 85000, 85700, 87140, 90250, 90800, 91260, 92800, 93040, 95900

### Mirion Technologies, Inc. (Sensing Systems Div.)

Atlanta, GA | [www.mirion.com](http://www.mirion.com)

Christy Phillips | 770/432-2744 | [cphillips@mirion.com](mailto:cphillips@mirion.com)

**Codes:** 03180, 03200, 03800, 04000, 08800, 09100, 09750, 09800, 12800, 13400, 14950, 17950, 21270, 21300, 21310, 22150, 25000, 26900, 26910, 26970, 28300, 28550, 38440, 40900, 45550, 47400, 51850, 54750, 55040, 56400, 56750, 58000, 58250, 62200, 63800, 69130, 69600, 70650, 71190, 72300, 73300, 74150, 75190, 75700, 75850, 77250, 77750, 78400, 79740, 80600, 83600, 84150, 84600, 85000, 85700, 86970, 87140, 90250, 90800, 91260, 92800, 93040, 95300, 95900

### Mitsubishi Nuclear Energy Systems, Inc. (A Sub. of Mitsubishi Heavy Industries, Ltd.)

Charlotte, NC | [mnes.mhi.com](http://mnes.mhi.com)

Scott Baumgartner | 980/250-0063 | [scott\\_baumgartner@mnes-us.com](mailto:scott_baumgartner@mnes-us.com)

**Codes:** 03000, 03800, 10780, 12750, 12800, 13200, 13850, 14000, 14300, 14810, 14950, 15200, 15300, 15600, 16000, 17200, 18600, 22410, 30500, 37600, 40900, 47400, 54300, 56900, 63000, 64120, 64700, 64750, 68000, 69600, 70650, 70900, 71700, 72300, 73300, 73550, 80730, 80800, 81680, 82250, 82800, 83150, 84150, 84600, 86300, 86400, 89500, 89510

### Mohawk Safety, Inc.

Manchester, CT | <https://mohawksafety.com/>

James W. Francoline | 860/643-5107 | 800/394-NUKE | [jfrancoline@mohawksafety.com](mailto:jfrancoline@mohawksafety.com)

**Stamps:** Certified Small Business. SAM Registered.

**Codes:** 08000, 10850, 10900, 14300, 26550, 26600, 27450, 36000, 37130, 50250, 64300, 73550, 77800, 79370, 83110, 83210, 95850\*

### Mound Technical Solutions, Inc.

Miamisburg, OH | [www.moundtech.com](http://www.moundtech.com)

Doug McClelland | 937/865-3715 | [doug@moundtech.com](mailto:doug@moundtech.com)

**Codes:** 04000, 55040, 74150

### Murray and Trettel, Inc.

Palatine, IL | [www.weathercommand.com](http://www.weathercommand.com)

John Boyle | 847/987-3536 | [john.boyle@weathercommand.com](mailto:john.boyle@weathercommand.com)

**Codes:** 12800, 14000, 26100

### NAC International Inc.

See advertisement on page 51

Peachtree Corners, GA | [www.nacintl.com](http://www.nacintl.com)

Ellen O'Shea | 678/328-1221 | 770/447-1144 | [eoshea@nacintl.com](mailto:eoshea@nacintl.com)

George Vaughan | 678/328-1222 | 770/447-1144 | [gvaughan@nacintl.com](mailto:gvaughan@nacintl.com)

**Codes:** 00400, 03800, 12800, 13850, 14000, 14300, 20300, 30040, 30500, 55490, 68000, 77800, 81710, 86300, 87000, 93040

### NAC LPT LLC

Mars, PA | [www.naclpt.com](http://www.naclpt.com)

Jeff Stahl | 484/542-0405 | [jstahl@naclpt.com](mailto:jstahl@naclpt.com)

**Codes:** 03800, 09950, 14000, 14300, 20300, 68000

### NAC Philotechnics, Ltd.

Oak Ridge, TN | [www.nacphilotech.com](http://www.nacphilotech.com)

Meghan Turvey | 865/483-1551 | [mgturney@philotechnics.com](mailto:mgturney@philotechnics.com)

Michael Miller | 724/480-7592 | [mmiller@nacphilotech.com](mailto:mmiller@nacphilotech.com)

**Codes:** 14000, 14300, 20300, 20350, 25600, 37200, 42400, 68950, 79370, 87000, 93040

### NAES Power Contractors, Inc.

Shelocta, PA | [www.naes.com](http://www.naes.com)

Jason Hardy | 360/388-0288 | [jason.hardy@naes.com](mailto:jason.hardy@naes.com)

**Stamps:** R Stamp

**Codes:** 13850, 14300, 20300

### National Inspection & Consultants

Fort Myers, FL | [www.nicinc.com](http://www.nicinc.com)

Michael D. Vigne | 239/939-4313 | [michael.vigne@iss-na.com](mailto:michael.vigne@iss-na.com)

**Stamps:** Certification to AS-9100-D & ISO 9001:2015. ISO 17025 & Nadcap accredited.

**Codes:** 06860, 14000, 40900, 66200, 68900, 84600, 86300

### Navarro

Oak Ridge, TN | [www.navarro-inc.com](http://www.navarro-inc.com)

JoEllen Kuzmaul | 865/220-9650 | [kuzmaul@navarro-inc.com](mailto:kuzmaul@navarro-inc.com)

Ryan Overton | 865/220-9650 | [overton@navarro-inc.com](mailto:overton@navarro-inc.com)

**Codes:** 03800, 12720, 12750, 12800, 13850, 14000, 20300, 25400, 26080, 26100, 37200, 64312, 67380, 68000, 86500, 93040

### Neotiss, Inc.

Morristown, TN | [www.neotiss.com](http://www.neotiss.com)

Wendy McGowan | 423/200-7089 | [wendy.mcgowan@neotiss.com](mailto:wendy.mcgowan@neotiss.com)

**Stamps:** ISO 9001:2000, PED 97/23/EC.

**Codes:** 87700, 87950, 88100\*

### Neptune and Company, Inc.

Lakewood, CO | [www.neptuneinc.org](http://www.neptuneinc.org)

Paul Black | 303/956-9867 | [pblack@neptuneinc.org](mailto:pblack@neptuneinc.org)

**Stamps:** GoldSim certified programmers and trainers; DABT; FEHM; ASTM; ProUCL; GiSDT; ISO

**Codes:** 03800, 12800, 14000, 86300, 93040

### NETCo

Windsor, ME | <https://netcoinc.net/>

Brock Bradford | 207/445-2228 | [brb@netcoinc.net](mailto:brb@netcoinc.net)

**Codes:** 17950, 21370, 21500, 26230, 47400, 68800, 75500, 75600, 75700, 75850, 86300

### Netzsch Instruments North America LLC

See advertisement on page 34

Burlington, MA | <https://analyzing-testing.netzsch.com/en-US>

Melinda Tucker | 303/895-8175 | [melinda.tucker@netzsch.com](mailto:melinda.tucker@netzsch.com)

Anthony Maletta | 781/825-5853 | [anthony.maletta@netzsch.com](mailto:anthony.maletta@netzsch.com)

**Codes:** 03800, 04000, 09870, 14000, 84150, 84600\*

### New Millennium Nuclear Technologies International

Lakewood, CO | [www.nmnuclear.com](http://www.nmnuclear.com)

Sue Aggarwal | 303/984-5788 | [saggarwal@nmnuclear.com](mailto:saggarwal@nmnuclear.com)

**Stamps:** Certification by ISO 9001.

**Codes:** 13050, 14000, 20350, 25600, 26100, 74320, 93040

### Newark Wire Cloth Co.

Cedar Grove, NJ | [www.newarkwire.com](http://www.newarkwire.com)

Richard W. Campbell | 973/778-4478 | 800/221-0392 | [rcampbell@newarkwire.com](mailto:rcampbell@newarkwire.com)

**Stamps:** ISO 9001:2015, AS9100 Rev. D

**Codes:** 27450, 47400, 49000, 81790



### Newton Research Labs, Inc.

Renton, WA | [www.newtonlabs.com](http://www.newtonlabs.com)

John Bramblet | 425/251-9600 | [jwb@newtonlabs.com](mailto:jwb@newtonlabs.com)

**Codes:** 12800, 30600, 39960, 40900, 70650, 73300, 84150, 84600

### Newton Security Inc.

Renton, WA | [www.newtonsecurityinc.com](http://www.newtonsecurityinc.com)

Jason Shipley | 425/251-9494 | [sales@newtonsecurity.com](mailto:sales@newtonsecurity.com)

**Codes:** 22800, 75700, 75850

### NextAxiom Technology, Inc.

San Francisco, CA | [www.nextaxiom.com](http://www.nextaxiom.com)

John Manoogian | 415/637-1580 | [info@nextaxiom.com](mailto:info@nextaxiom.com)

**Stamps:** ISO9001 Certified

**Codes:** 12750, 12800

### Nextteq International LLC

Tampa, FL | [www.nextteq.com](http://www.nextteq.com)

Ryan Day | 813/249-5888 | 877/312-2333 x126 | [info@nextteq.com](mailto:info@nextteq.com)

**Codes:** 03000, 03800, 04000, 26080, 32250, 37130, 37200, 54750, 64750, 73550, 74150, 84150\*

### NFT (by Alpha Safety Group)

Golden, CO | [www.nftinc.com](http://www.nftinc.com)

Marc Rood | 303/910-7830 | [mrood@nftinc.com](mailto:mrood@nftinc.com)

Terry Wickland | 303/384-9785 | [twickland@nftinc.com](mailto:twickland@nftinc.com)

**Codes:** 14300, 27450, 68000, 77800, 90100, 93040

### North Wind Group

Idaho Falls, ID | [www.northwindgrp.com](http://www.northwindgrp.com)

Brady Bigelow | 303/263-9201 | [bbigelow@northwindgrp.com](mailto:bbigelow@northwindgrp.com)

Andy Williams | 419/707-2135 | [andy.williams@northwindgrp.com](mailto:andy.williams@northwindgrp.com)

**Codes:** 03800, 06790, 09750, 09800, 13850, 14000, 19280, 20350, 22410, 37130, 37200, 47400, 71190, 86300, 87000, 93040

### NSL Analytical Services, Inc.

Cleveland, OH | [www.nslanalytical.com](http://www.nslanalytical.com)

Jeff Hartel | 216/438-5200 | 800/497-6752 | [techsales@nslanalytical.com](mailto:techsales@nslanalytical.com)

Ed Herderick | 216/438-5200 | 216/527-5326 | [eherderick@nslanalytical.com](mailto:eherderick@nslanalytical.com)

**Stamps:** 10 CFR Part 21 reporting program, with compliance to applicable requirements from 10CFR50 App. B and ASME NQA-1. Certified test reports, in accordance with ASME section III NCA-3800. Audited by NIAC and NUPIC member customers. Chemical, Mechanical, Metallurgical testing. ISO/IEC 17025:2017 [ANAB] and Nadcap accredited, NQA-1 compliant.

**Codes:** 03800, 84600

### NSSI/Recovery Services Inc.

Houston, TX | [www.nssihouston.com](http://www.nssihouston.com)

Gamaliel Torres | 713/641-0391 | [gtorres@nssienvironmental.com](mailto:gtorres@nssienvironmental.com)

**Codes:** 09800, 14000, 14300, 20300, 20350, 25600, 37200, 41000, 50250, 67380, 68000, 68950, 73450, 77750, 77800, 84600, 86300, 87000, 87380, 87395, 87400, 93040, 95300

### Nuclear Care Partners

Grand Junction, CO | [www.nuclearcarepartners.com](http://www.nuclearcarepartners.com)

Brad Parish | 865/804-2723 | [bparish@nuclearcarepartners.com](mailto:bparish@nuclearcarepartners.com)

**Codes:** 14000

### Nuclear Economics Consulting Group (NECG)

Alexandria, VA | [www.nuclear-economics.com](http://www.nuclear-economics.com)

Edward Kee | 202/370-7713 | [edk@nuclear-economics.com](mailto:edk@nuclear-economics.com)

**Codes:** 14000

### Nuclear News Magazine

Westmont, IL | [www.ans.org/news](http://www.ans.org/news)

Rick Michal | 708/579-8216 | [nucnews@ans.org](mailto:nucnews@ans.org)

Jeff Mosses | 708/579-8225 | [nucnews1@ans.org](mailto:nucnews1@ans.org)

**Codes:** 40700, 64315

### Nuclear Shielding Supplies & Service

Tucson, AZ | [www.nuclearshielding.com](http://www.nuclearshielding.com)

Cari Barros | 520/838-0961 | [info@nuclearshielding.com](mailto:info@nuclearshielding.com)

Russell Pruett | 520/838-0951 | [info@nuclearshielding.com](mailto:info@nuclearshielding.com)

**Codes:** 13700, 14000, 14300, 22800, 36900, 55490, 66280, 77750, 77800\*

### NuclearConsultants.com

Ann Arbor, MI | [www.nuclearconsultants.com](http://www.nuclearconsultants.com)

Dale Lancaster | 814/574-1912 | [dale@nuclearconsultants.com](mailto:dale@nuclearconsultants.com)

**Codes:** 03200, 03800, 12800, 14000, 14300, 30040, 30600, 77750, 77800, 81680

### NuclearN

Phoenix, AZ | <https://nuclearn.ai>

[contact@nuclearn.ai](mailto:contact@nuclearn.ai)

Adam KP Brown | 847/287-2616 | [adam@nuclearn.ai](mailto:adam@nuclearn.ai)

**Codes:** 03800, 12750, 12800, 14000, 19700, 40700, 47400, 57000, 70600\*

### NUCON International, Inc.

See advertisement on page 30

Columbus, OH | [www.nucon-int.com](http://www.nucon-int.com)

Sales | 614/846-5710 | 800/992-5192 | [sales@nucon-int.com](mailto:sales@nucon-int.com)

Gabor Muzsi | 614/846-5710 x136 | 800/992-5192 | [sales@nucon-int.com](mailto:sales@nucon-int.com)

**Codes:** 03000, 04000, 09800, 09900, 14000, 14810, 19450, 21310, 21400, 25000, 26100, 26230, 27150, 27180, 27250, 27450, 32250, 39300, 40900, 41000, 41700, 47400, 54750, 55040, 56600, 68000, 73550, 79370, 84150, 84600, 86300, 87380, 87400, 93240, 93500

### Numerical Advisory Solutions, LLC

Cary, NC | <https://www.numerical.com/>

Bristol Hartlage | 919/653-7657 | 619/888-3439 | [hartlage@numerical.com](mailto:hartlage@numerical.com)

**Stamps:** ASME NQA-1, 10CFR50 App. B

**Codes:** 03800, 06860, 12720, 12750, 12800, 13850, 14000, 19280, 19700, 20300, 23850, 25400, 28000, 28150, 40900, 44090, 60900, 67380, 71190, 75600\*

### NuScale Power

Portland, OR | [www.nuscalepower.com](http://www.nuscalepower.com)

Chuck Goodnight | 541/452-7849 | 703/217-7954 | [cgoodnight@nuscalepower.com](mailto:cgoodnight@nuscalepower.com)

**Codes:** 56900

### NuSource LLC

Alexandria, VA | [www.nusourcecellc.com](http://www.nusourcecellc.com)

Waylon Waters | 810/223-4483 | [wwaters@nusourcecellc.com](mailto:wwaters@nusourcecellc.com)

**Stamps:** ASME N Stamp, ASME NPT Stamp

**Codes:** 03000, 03800, 07800, 08400, 08800, 13180, 13200, 13220, 14000, 14300, 14810, 15200, 17200, 22800, 24300, 26900, 27180, 27450, 27650, 28400, 28530, 28550, 37600, 37700, 37720, 37800, 41700, 49000, 53950, 57050, 59820, 60100, 60450, 60900, 64320, 66280, 69600, 76600, 77250, 77700, 79740, 81790, 82250, 82950, 83150, 85700, 87950, 88000, 88100, 88200, 90600, 90800, 91260, 91380, 92150, 92300\*

### Nuttall Gear LLC

Niagara Falls, NY

Michael Suszek | 716/298-4100 | [michael.suszek@nutallgear.com](mailto:michael.suszek@nutallgear.com)

**Codes:** 33500

### NuVision-HWM (Wälischmiller Engineering)

Pittsburgh, PA | [www.nuvisionengineering.com](http://www.nuvisionengineering.com)

Joe Dixon | 651/356-5605 | [jdixon@nuvisioneng.com](mailto:jdixon@nuvisioneng.com)

**Codes:** 10780, 12800, 36000, 47400, 47600, 53950, 68000, 72300, 73300, 73620, 86150, 93800\*



# Directory of Suppliers

## OAK-PAR

### Oak Ridge National Laboratory

See advertisement on page 3

Oak Ridge, TN | <https://www.ornl.gov/>

Laura Scheele | 219/381-8672 | [scheelela@ornl.gov](mailto:scheelela@ornl.gov)

**Codes:** 03800, 70600, 73400, 73450, 73620, 86300

### Oakleaf Environmental, Inc.

Knoxville, TN

Troy Eshleman | 865/719-8179 | [troyeshleman34@gmail.com](mailto:troyeshleman34@gmail.com)

**Codes:** 14000

### Off-Site Source Recovery Program (Los Alamos National Laboratory)

Los Alamos, NM | [osrp.lanl.gov](mailto:osrp.lanl.gov)

**Codes:** 25600, 93040

### Orano Decommissioning Services

Hudson, MA | <https://www.orano.group/usa/en/our-portfolio-expertise/decommissioning-services>

Matt Lucas | 301/841-1776 | [matthieu.lucas@orano.group](mailto:matthieu.lucas@orano.group)

**Codes:** 20300, 68000, 87000, 93040

### Orano Federal Services

Charlotte, NC | <https://www.orano.group/usa/en/our-portfolio-expertise/federal-services>

Curtis Roberts | 202/374-8766 | [curtis.roberts@orano.group](mailto:curtis.roberts@orano.group)

**Codes:** 09730, 13850, 14300, 20300, 36000, 68000\*

### Orano TN

Columbia, MD | <https://www.orano.group/usa/en/our-portfolio-expertise/used-fuel-management>

Roger Maggi | 434/841-1859 | [roger.maggi@orano.group](mailto:roger.maggi@orano.group)

**Codes:** 14300, 20300, 68000, 81680, 81710, 87000, 93040

### Orano USA

Bethesda, MD | <https://www.orano.group/usa>

Curtis Roberts | 202/374-8766 | [curtis.roberts@orano.group](mailto:curtis.roberts@orano.group)

**Codes:** 09950, 14000, 14300, 20300, 20350, 30040, 30450, 30600, 36000, 39960, 64312, 68000, 68950, 73350, 73400, 79360, 81680, 81710, 86250, 87000, 89580, 89590, 89600, 89650, 89760, 89795, 89800, 93040

### ORTEC

Oak Ridge, TN | [www.ortec-online.com](http://www.ortec-online.com)

865/482-4411 | 800/251-9750 | [ortec.info@ametek.com](mailto:ortec.info@ametek.com)

**Codes:** 03200, 03550, 03800, 04000, 09750, 09800, 12800, 16800, 17950, 19700, 21270, 25000, 25250, 26080, 26230, 35650, 37130, 55040, 55060, 56470, 58000, 63400, 63800, 64750, 69130, 69140, 69600, 73770, 74150, 74400, 75850, 77000, 77800, 79850, 86300

### OTEK Corp.

See advertisement on page 62

Tucson, AZ | [www.otekcorp.com](http://www.otekcorp.com)

Dr. Otto Fest | 520/748-7900 | [sales@otekcorp.com](mailto:sales@otekcorp.com)

**Stamps:** Class 1E/Appendix B & MIL-Spec Manufacturer

**Codes:** 14950, 15200, 17950, 18400, 25000, 40050, 51850, 53600, 53950, 54750, 55470, 69130, 69600, 84150\*

### Overhoff Technology Corp. (A Div. of US Nuclear Corp.)

Milford, OH | [www.overhoff.com](http://www.overhoff.com)

Dell Williamson | 513/248-2400 | [sales@overhoff.com](mailto:sales@overhoff.com)

Ian Embry | 818/883-7043 | [ian@overhoff.com](mailto:ian@overhoff.com)

**Codes:** 03200, 17950, 21270, 24400, 26080, 55040\*

### Pacific Development Services Inc.

Carson City, NV | [pdsgroup.com](http://pdsgroup.com)

John Ritchie | +356-99900374 | [ritchie@pdsgroup.com](mailto:ritchie@pdsgroup.com)

**Codes:** 14000, 14300

### PacTec, Inc.

See advertisement on page 58

Clinton, LA | [www.pactecinc.com](http://www.pactecinc.com)

Mike Sanchez | 225/683-8602 | 877/554-2541 | [mikesanchez@pactecinc.com](mailto:mikesanchez@pactecinc.com)

**Stamps:** IP-1, IP-2 & 7A Type A IP-3 flexible packaging, macroencapsulation bags for LLMW, LSA and SCO wraps/overpacks and more. ISO 9001:2015

**Codes:** 09950, 14300, 20300, 22410, 27450, 37130, 37160, 68000, 77800, 79360, 87000\*

### Pajarito Scientific Corp.

Santa Fe, NM | [www.pajaritoscientific.com](http://www.pajaritoscientific.com)

Michael Pitts | 505/603-7332 | [mpitts@pscnda.com](mailto:mpitts@pscnda.com)

**Stamps:** Certification to ISO 9001-2015. NQA-1 Compliant.

**Codes:** 00400, 02910, 03000, 03200, 03550, 03800, 04000, 06820, 06840, 06860, 08100, 09800, 12750, 12800, 14000, 14300, 14810, 17950, 20300, 21400, 22800, 25350, 26080, 26100, 26230, 27180, 27450, 30040, 30600, 32250, 36000, 40900, 41000, 47400, 55040, 56600, 66200, 67380, 68000, 68900, 69600, 74150, 77750, 77800, 79850, 84600, 86300, 93040\*

### PAR Systems, LLC

Saint Paul, MN | [www.par.com](http://www.par.com)

Rob Owen | 651/528-5226 | 800/464-1320 | [rowen@par.com](mailto:rowen@par.com)

Tracy Sherk | 651/484-7261 | [tsherk@par.com](mailto:tsherk@par.com)

**Stamps:** ISO 9001/AS9100, ASME NQA-1 (2008, 2009-A), Military, DOE, and other Aerospace and Commercial Quality Programs, CE, UL, FCC, SEMI, ANSI, NEC, NFPA, RIA

**Codes:** 03800, 08800, 10780, 12750, 12800, 14000, 18590, 18600, 20300, 20350, 20700, 22800, 23850, 27180, 28250, 30500, 36820, 39650, 40900, 44080, 46950, 47400, 47600, 48050, 53950, 56600, 66280, 68000, 68800, 70650, 72300, 73300, 73620, 79360, 81710, 84150, 86130, 93040, 93800, 93900

### Par-Kut International, Inc.

Harrison Twp., MI | [security-booth.parkut.com](http://security-booth.parkut.com)

Tom Duemling | 586/468-2947 | 800/394-6599 | [sales@parkut.com](mailto:sales@parkut.com)

Larry Moore | 586/468-2947 | [lmoore@parkut.com](mailto:lmoore@parkut.com)

**Codes:** 75700

### Paragon Energy Solutions (Paragon)

See advertisement on cover 4

Fort Worth, TX | [www.paragones.com](http://www.paragones.com)

John Portillo | 817/239-1693 | 817/284-0077 | [jportillo@paragones.com](mailto:jportillo@paragones.com)

Tighe Smith | 865/966-5330 | [tsmith@paragones.com](mailto:tsmith@paragones.com)

**Stamps:** ASME NQA-1, 10CFR50 App. B, N299.1, ASME Section III N, NR, NPT and NS stamps

**Codes:** 03000, 03180, 03200, 03550, 03800, 04000, 06860, 07040, 07060, 07070, 07080, 07100, 07120, 07200, 07330, 07800, 08400, 08800, 09100, 09400, 12100, 12720, 12750, 12800, 12900, 13400, 13600, 14000, 14950, 15600, 17950, 18400, 19280, 19450, 19700, 21270, 22150, 22200, 22660, 22800, 24000, 24180, 24300, 25000, 25400, 26240, 26900, 27450, 28300, 28400, 28530, 31700, 33400, 35800, 37600, 40050, 41450, 42600, 42870, 46810, 47400, 49000, 51850, 55300, 55470, 56400, 57050, 61800, 63400, 63800, 64700, 64750, 67380, 69600, 71900, 75190, 76400, 77250, 79740, 82950, 83150, 83210, 84600, 85000, 85700, 86300, 86750, 86870, 86970, 87140, 90000, 90250, 90600, 90800, 91000, 91260, 91380, 93220

### The Park Company

See advertisement on page 63

Pasco, WA | [www.theparkcompany.com](http://www.theparkcompany.com)

Michael Christianson | 509/547-9929 | [mpc@theparkcompany.com](mailto:mpc@theparkcompany.com)

**Codes:** 24300, 26240, 30500, 55040, 64700, 64750, 89510, 90250, 90600, 90800, 91000, 91260, 91380



### Paschal Solutions, Inc.

Knoxville, TN | [www.paschalsolutions.com](http://www.paschalsolutions.com)  
 Tracey Henson | 270/705-9037 | [thenson@paschalsolutions.com](mailto:thenson@paschalsolutions.com)  
 Brad Dunn | 865/300-5614 | [bdunn@paschalsolutions.com](mailto:bdunn@paschalsolutions.com)  
**Codes:** 03200, 03800, 14000, 20300

### Paxton & Vierling Steel

Carter Lake, IA | <https://owenmetalsgroup.com/industrial-fabrication/>  
 Joseph Wishard | 712/347-5500 | [jwishard@pvsteel.com](mailto:jwishard@pvsteel.com)  
**Stamps:** NQA-1, ISO, AISC, AWS, RCSC, NACE, SSPC, AMPP  
**Codes:** 03800, 07330, 10780, 11400, 11600, 12800, 13700, 14000, 14810, 22800, 26500, 26900, 28250, 40900, 49000, 50350, 56600, 57600, 77750, 82250\*

### Perma-Fix Environmental Services, Inc.

Oak Ridge, TN | [www.perma-fix.com](http://www.perma-fix.com)  
 Brian Wood | 352/251-2071 | 800/905-0501 | [bwood@perma-fix.com](mailto:bwood@perma-fix.com)  
 Jessie McDonough | 865/251-2088 | 800/905-0501 | [jmcdonough@perma-fix.com](mailto:jmcdonough@perma-fix.com)  
**Codes:** 09750, 09800, 13850, 14000, 17950, 20300, 20350, 20700, 26080, 26100, 26230, 37130, 37200, 39300, 40900, 41000, 44000, 47400, 63000, 66200, 67380, 68000, 68950, 69600, 84150, 93040

### The Perma-Type Company, Inc.

Plainville, CT | [www.permatyperubber.com](http://www.permatyperubber.com)  
 Betsy Perry | 860/747-9999 | 800/243-4234 | [reachus@emailptusa.com](mailto:reachus@emailptusa.com)  
**Codes:** 20250, 29360, 61570, 75190\*

### Petersen Inc. (A Precinmac Company)

**See advertisements on pages 13 and 73**  
 Ogden, UT | [www.peterseninc.com](http://www.peterseninc.com)  
 Jason Patterson | 801/732-2476 | 801/317-7519 | [jason.patterson@peterseninc.com](mailto:jason.patterson@peterseninc.com)  
**Stamps:** NBIC R Stamp; ASME VIII Div. 1 U Stamp; ASME VIII Div. 2 U2 Stamp; ASME Section 1 S Stamp; ASME NQA-1; ASME B31.1, B31.3, B31.4, B31.8; NRC-Subpart H of 10 CFR Part 71, 10CFR50 App. B; ANSI N14.5; API 650, 1104; AWS D1.1, D1.2, D1.3, D1.6, D17.1; ISO 9001-2015; AS9100 Rev. D; NADCAP; AISC  
**Codes:** 09730, 14300, 22800, 26500, 36000, 36820, 36850, 46950, 47400, 48050, 49000, 50250, 56600, 56750, 60900, 64000, 68000, 77700, 81680, 81710, 82200, 83150, 86130, 87000, 91000, 92150, 92300, 93220, 96200

### PHDS Co.

Knoxville, TN | [www.phdsco.com](http://www.phdsco.com)  
 Ethan Hull | 865/481-3725 | [ethanhull@phdsco.com](mailto:ethanhull@phdsco.com)  
**Codes:** 17950, 20300, 21270, 26230, 37130, 37200, 40900, 41015, 42870, 55040, 68800, 68950, 89650, 89760, 89795, 93040

### Pioneer Motor Bearing Co.

Kings Mountain, NC | [www.pioneer1.com](http://www.pioneer1.com)  
 Don McGinnis | 704/937-7000 | 888/813-9001 | [sales@pioneer1.com](mailto:sales@pioneer1.com)  
**Codes:** 03800, 07100, 07120, 14000, 47400

### Piping Technology & Products, Inc.

Houston, TX | [www.pipingtech.com](http://www.pipingtech.com)  
 Robert Cornelius | 713/731-0030 | 800/787-5914 | [info@pipingtech.com](mailto:info@pipingtech.com)  
**Stamps:** ASME U Stamp, ISO 9001:2008 for Pre-Insulated Supports  
**Codes:** 07200, 19450, 28400, 37600, 38440, 43700, 47400, 49000, 58250, 60100, 60450, 75190, 76600, 77860, 79000, 92300

### Plastocor, Inc.

Hingham, MA  
 Jim Mitchell | 724/942-0582 | [jem@plastocor.com](mailto:jem@plastocor.com)  
**Codes:** 11400, 13200, 37600, 47400

### PMT Nuclear

Woodridge, IL | [www.pmtnuclear.com](http://www.pmtnuclear.com)  
 Charles Wojcik | 630/887-7700 | 630/320-7730 | [cwojick@ams-pmt.com](mailto:cwojick@ams-pmt.com)  
 Mike Marcuccilli | 630/470-7960 | [mmarcuccilli@ams-pmt.com](mailto:mmarcuccilli@ams-pmt.com)  
**Stamps:** PP, R, U.

**Codes:** 03000, 03800, 06860, 07100, 07120, 07200, 07800, 12100, 13180, 13700, 13850, 14000, 18400, 19450, 22800, 23850, 24000, 24300, 26550, 26900, 27150, 27180, 27450, 28400, 28530, 31400, 36850, 37600, 37800, 38440, 40900, 41200, 43700, 44090, 46950, 47400, 49000, 50300, 50350, 59800, 59820, 59850, 60100, 60150, 60900, 71500, 73720, 75190, 75700, 77700, 77750, 79740, 80400, 82250, 82950, 83150, 84100, 84600, 86300, 86500, 86750, 86870, 86970, 87950, 88000, 88100, 90000, 90250, 92300, 93900

### Power & Energy Systems Services

Oradell, NJ  
 Komandur Sunder Raj | 201/638-4635 | [powerengy@aol.com](mailto:powerengy@aol.com)  
**Codes:** 03800, 12800, 14000, 86300, 86500\*

### Power Services Group (Power Plant Services, Orbital Energy Services, Aircro, Turbine Generator Maintenance)

Cape Coral, FL | [www.powerservicesgroup.com](http://www.powerservicesgroup.com)  
 Mike Lake | 800/226-7557 | 800-MrTurbine | [inquiries@powerservicesgroup.com](mailto:inquiries@powerservicesgroup.com)  
**Stamps:** ISO 9001:2015, AS9100D Certified  
**Codes:** 40900, 47400, 80730, 80800, 89500, 89510

### Powerfect Service, Inc.

Brick, NJ | [www.powerfect.com](http://www.powerfect.com)  
 Mary Jane Luddy | 732/202-1178 | [powerfect@verizon.net](mailto:powerfect@verizon.net)  
 Eric Svensson | 732/202-1133 | [eric@powerfect.com](mailto:eric@powerfect.com)  
**Codes:** 10780, 14000, 37600, 38000, 54300, 84430, 86300

### Precision Custom Components, LLC. (DC Fabricators)

**See advertisement on page 90**  
 York, PA | [www.pcc-york.com](http://www.pcc-york.com)  
 Blair Woodring | 717/848-1126 | [bwoodring@pcc-york.com](mailto:bwoodring@pcc-york.com)  
**Stamps:** ASME Sec III Div 1, 2, 3 & 5; NQA-1, NCA 3800, Mil-Q-9858, Mil-I-45208  
**Codes:** 03800, 09800, 10010, 11600, 14000, 14300, 14810, 30500, 36000, 37600, 40900, 46950, 47400, 49000, 49700, 53950, 56600, 56900, 64120, 66280, 73350, 77700, 78100, 80800, 81710, 83150, 88000, 92300, 93750, 93900

### Preferred Engineering Corp. (Sub. of Preferred Utilities Mfg. Corp.)

**See advertisement on page 127**  
 Danbury, CT | [www.preferredengineering.com](http://www.preferredengineering.com)  
 Steven Mitchell | 203/743-6741 x1402 | [smitchell@preferred-mfg.com](mailto:smitchell@preferred-mfg.com)  
 Christopher Bohn | 203/743-6741 x1403 | [cbohn@preferred-mfg.com](mailto:cbohn@preferred-mfg.com)  
**Codes:** 03800, 14000, 20350, 30500, 33360, 36820, 39650, 47400, 48300, 53950, 54000, 61570, 72300, 75190, 77800, 80730, 86500, 91260, 96300

### Preferred Quality Services, Inc.

Jacksonville, FL  
 Johnnie O. Poston | 904/451-8316 | [joposton@bellsouth.net](mailto:joposton@bellsouth.net)  
**Codes:** 06860, 14000

### Premier Technology, Inc.

Blackfoot, ID | [www.ptius.com](http://www.ptius.com)  
 Heath Mann | 208/681-2534 | [hmann@ptius.net](mailto:hmann@ptius.net)  
**Stamps:** ASME NQA-1, ASME Section VIII, National Board R Stamp, ASME Code Stamps S & U, ASME NTP, NA & NS Stamps for Nuclear Applications, 10CFR21 and 10CFR50 Appendix B QA programs  
**Codes:** 03800, 08800, 12800, 13700, 14000, 14300, 18400, 22800, 23850, 26500, 27450, 36000, 36820, 37600, 45550, 47400, 50250, 53950, 55490, 56600, 56750, 58250, 60900, 68000, 70650, 77750, 77800, 79360, 80520, 81710, 83150, 88000, 92300, 93040, 93900, 95750



# Directory of Suppliers

PRE-RDF

## Presray Corp. (Div. of Pawling Corp.) (Critical Containment Solutions)

See advertisement on page 61

Wassaic, NY | www.presray.com

Jason Smith | 845/373-6620 | jsmith@presray.com

Kevin Harris | 845/373-6718 | kharris@presray.com

**Codes:** 22800, 33360, 75190, 75700\*

## Primm Consulting, LLC

Knoxville, TN | www.primmconsultingllc.com

Trent Primm | 865/805-2130 | trentprimm@primmconsultingllc.com

**Codes:** 12800, 14000, 30450, 70900, 73400

## PROTEM USA LLC

Evergreen, CO | www.protemusa.com

Erik Bensoussan | 303/955-4862 | contact@protemusa.com

**Stamps:** ISO 9001 V2015, CEFR1 667 E, EDF UTO 85/114

**Codes:** 03800, 07310, 08800, 10780, 14000, 20300, 22700, 24000, 28530, 40900, 47400, 48050, 53950, 59850, 64120, 70650, 80730, 86300, 93800, 93900\*

## Prysmian Cables & Systems USA, LLC

Claremont, NC | https://na.prysmiangroup.com/

Jerry Knight | 828/455-3044 | jerry.knight@prysmiangroup.com

Paul Baird | 828/238-7443 | paul.baird@prysmiangroup.com

**Stamps:** 10CFR50 App. B Program/ASME NQA-1

**Codes:** 09100

## Prysmian North America

Highland Heights, KY | na.prysmiangroup.com

Ben Leininger | 859/572-8492 | na.nuclear@prysmiangroup.com

**Stamps:** ASME NQA-1, NUPIC, NIAC

**Codes:** 08800, 09100, 26970

## PTP Spent Fuel Services, LLC

Grand Island, NY | www.ptpsfs.com

Bill Schaab | 716/984-7566 | 866/699-5515 | ptp@ptpsfs.com

**Codes:** 06860, 14000, 14300, 18600, 20250, 20300, 20700, 30040, 30500, 47400, 68000, 81680, 81710, 87000, 93040\*

## Pyragon Electronic Instrumentation

Rochester, NY | pyragon.com

Tom Crumlish | 585/697-0444 | tcrumlish@sorinc.com

**Stamps:** ISO9001:215 and Nuclear N299.2

**Codes:** 25000, 86750\*

## QTRCO, Inc.

Tomball, TX | www.qtrco.com

Shawn Hughes | 281/516-0277 | 888/228-8848 | shawnhughes@qtrco.com

**Codes:** 90250

## R&G Laboratories, Inc.

Tampa, FL | www.randglabs.com

Cheryl Huff | 813/643-3513 | 866/854-1177 | cheryl@randglabs.com

**Stamps:** 10CFR50 App. B QA/QC program and ISO 17025

**Codes:** 03800, 14300, 39300, 39400

## Radiation Pros, LLC (dba Rad Pros)

Englewood, CO | www.radpros.com

Kurt Rhea | 303/945-5381 | 720/771-0200 | kurt.rhea@radpros.com

**Codes:** 26100, 26230, 37200, 54750, 55060, 58000, 67380, 79360, 86300, 93040

## Radiation Protection Systems (by Alpha Safety)

Groton, CT | www.radpros.com

Arthur D. Soma | 614/725-7929 | 860/445-0334 x102 | asoma@radpros.com

Haley Stout Veroneau | 860/445-0334 x273 | 888/637-7779 | hstout@radpros.com

**Stamps:** NRTL/CSA Certified HEPA Filtration Units, QAPP

**Codes:** 00400, 03000, 10780, 12750, 14000, 14300, 19450, 20300, 22800, 23850, 27150, 27180, 27250, 27450, 31400, 32250, 37130, 37200, 47400, 50250, 68000, 77750, 77800, 82310, 93040\*

## Radiation Safety & Control Services, Inc.

See advertisement on cover 3

Seabrook, NH | www.radsafety.com

Matthew Whetzel | 603/474-6733 | 800/525-8339 | mdwhetzel@radsafety.com

**Stamps:** ISO/IEC 17025

**Codes:** 03180, 03200, 03800, 04000, 06860, 09750, 09800, 10850, 12800, 14000, 14300, 17950, 20300, 21270, 22410, 23850, 24400, 25250, 25300, 25350, 25400, 26080, 26100, 26230, 27450, 37160, 37200, 40900, 41000, 44000, 47400, 47620, 53950, 55040, 55060, 55500, 64312, 67380, 68950, 69130, 69140, 73450, 74400, 75850, 84150, 84600, 86130, 86300, 86400, 93040

## Radiological Solutions Inc.

Rockdale, IL | www.radiologicalsolutions.com

Richard Kohlmann | 815/207-4300 | rkohlmann@radiologicalsolutions.com

**Codes:** 04000, 14000, 20350, 26080, 27180, 27450, 37200, 37600, 53950, 54750, 55040, 64750, 67380, 68000, 74150, 86300, 93040

## Radium Inc.

Waynesboro, VA | www.radiuminc.com

Cam Abernethy | 540/942-5734 | cabernethy@radiuminc.com

**Codes:** 10850, 10900, 11650, 12800, 14000, 14300, 22660, 25400, 26230, 36000, 37130, 45550, 47600, 56750, 70650, 72300, 73300, 73550, 73620, 75850, 77750, 77800, 80730, 83600, 92800

## Radkut (Radkut by Lango's Design)

Walkersville, MD | www.radkut.com

Mai Bull Roberts | 240/315-1142 | radkut@langosdesign.com

**Codes:** 37130

## RadQual, LLC

Idaho Falls, ID | www.radqual.com

Kevin Coltellaro | kcoltellar@intisoid.com

Terri Snarr | 208/524-5300 | sales@radqual.com

**Codes:** 68950, 79700\*

## Radwaste Solutions Magazine

Westmont, IL | www.ans.org/news

Tim Gregoire | 414/530-2455 | editor@radwastesolutions.org

Jeff Mosses | 708/579-8225 | radwastemag@ans.org

**Codes:** 40700, 64315

## Ray Termini & Associates LLC

Wheaton, IL

Ray Termini | 630/818-5707 | raytermini79@gmail.com

**Stamps:** PMP, Project Management Professional

**Codes:** 14000

## RdF Corporation

See advertisement on page 105

Hudson, NH | www.rdfcorp.com

DerZen Fan | 603/882-5195 | dfan@rdfcorp.com

Shyang Puri | 603/882-5195 | spuri@rdfcorp.com

**Stamps:** NQA-1; ISO9001-2015; AS9100D; CSAN299.1

**Codes:** 09750, 09800, 09870, 14950, 22150, 40050, 51730, 51850, 54750, 77250, 84150, 84600, 85000, 85200, 85400, 85700, 86750



## Red Wolf Associates

Cary, NC | [www.redwolfassociates.com](http://www.redwolfassociates.com)

Joe Sinodis | 919/467-9686 x120 | [joe.sinodis@redwolfassociates.com](mailto:joe.sinodis@redwolfassociates.com)

Nathan Block | 919/467-9686 x110 | [nathan.block@redwolfassociates.com](mailto:nathan.block@redwolfassociates.com)

**Codes:** 03800, 12750, 12800, 14000, 20300, 28000, 28150, 37200, 37660, 60900, 77750, 86300

## Reef Industries, Inc. (Griffolyn, Div. of Reef Industries, Inc.)

See advertisement on page 95

Houston, TX | [www.reefindustries.com](http://www.reefindustries.com)

Mark Mullin | 800/231-6074 | [mmullin@reefindustries.com](mailto:mmullin@reefindustries.com)

**Stamps:** NFPA 701 Large Scale Test, SEG Certified Incinerable.

**Codes:** 08800, 11400, 14300, 26550, 37130, 45700, 47670, 64300, 68000, 77800, 81710, 83210, 93040

## Remote Ocean Systems (ROS)

See advertisement on page 100

San Diego, CA | [www.rosys.com](http://www.rosys.com)

James Connell | 858/565-8500 | [jamesc@rosys.com](mailto:jamesc@rosys.com)

**Codes:** 72300, 73300, 83600\*

## Remtech Inc.

The Villages, FL | [www.remtechinc.com](http://www.remtechinc.com)

Tom Schreiber | 303/772-6825 | [sales@remtechinc.com](mailto:sales@remtechinc.com)

**Codes:** 14000, 26080, 51730

## ReNuke

Oak Ridge, TN | [www.renuke.com](http://www.renuke.com)

Mark Kirshe | 410/991-7628 | [mark@renuke.com](mailto:mark@renuke.com)

**Codes:** 14000, 17950, 20300, 25400, 37130, 37200, 55040, 55060, 67380, 74150, 86300, 93040

## Republic Services

Livonia, MI | [www.republicservices.com/es](http://www.republicservices.com/es)

Pia Shah | 947/204-9623 | [pshah@republicservices.com](mailto:pshah@republicservices.com)

**Codes:** 14000, 20300, 20350, 20700, 47400, 87000, 93040

## Rexon Components, Inc.

Beachwood, OH | [www.rexon.com](http://www.rexon.com)

Dr. M. R. Farukhi | 216/292-7373 | [sales@rexon.com](mailto:sales@rexon.com)

**Codes:** 09750, 14000, 17950, 20350, 21270, 26230, 26240, 36000, 37130, 37160, 46950, 47400, 50300, 55040, 55060, 77830, 96700

## Rich Industries Inc.

New Philadelphia, OH | [www.richindustriesinc.com](http://www.richindustriesinc.com)

David Patterson | 330/447-3764 | 330/339-4113 | [davepatterson@richindustriesinc.com](mailto:davepatterson@richindustriesinc.com)

**Codes:** 10850, 10900, 14300, 26550, 36000, 37130, 37160, 38440, 40900, 47400, 64300, 68000, 77800, 78700, 79360, 80730, 82310, 83210, 93800

## Right Brain Security

Oswego, IL | [rbsecurty.com](http://rbsecurty.com)

Roger Johnston | 630/551-0740 | [roger@rbsecurty.com](mailto:roger@rbsecurty.com)

**Codes:** 03800, 06860, 14000, 73770, 75600, 75850, 86300

## River Technologies, LLC

Forest, VA | [www.rivertechnologies.biz](http://www.rivertechnologies.biz)

Robert Kozma | 434/525-4734 | [robert@rivertechnologies.biz](mailto:robert@rivertechnologies.biz)

Daniel Ferguson | 434/535-4734 | 434/907-2399 | [daniel@rivertechnologies.biz](mailto:daniel@rivertechnologies.biz)

**Codes:** 00400, 03000, 10780, 19450, 20350, 26230, 27450, 38440, 48050, 56600, 79370, 84150, 90100\*

## RKVST

Santa Clara, CA | [www.rkvst.com](http://www.rkvst.com)

Patrick Reilly | 408/667-8302 | [patrick.reilly@rkvst.com](mailto:patrick.reilly@rkvst.com)

Cindy Vestergaard | 202/594-2165 | [cind.vestergaard@rkvst.com](mailto:cind.vestergaard@rkvst.com)

**Codes:** 12800, 19280, 19700

## Robatel Technologies, LLC

Roanoke, VA | [www.robateltech.com](http://www.robateltech.com)

Jared Bower | 540/989-2878 | [info@robateltech.com](mailto:info@robateltech.com)

**Stamps:** ASME NQA-1, 10CFR Part 71

**Codes:** 14000, 14300, 20300, 22800, 25600, 30500, 31600, 36000, 36820, 39300, 39400, 47400, 47600, 48050, 49000, 50250, 55040, 55490, 61800, 66280, 68000, 68950, 70650, 72300, 73350, 73400, 77800, 79360, 81710, 83150, 86130, 93040, 96200

## Roberts Engineering Services, Inc.

Stuart, FL

C. L. Roberts | 772/528-1088 | [res1977@bellsouth.net](mailto:res1977@bellsouth.net)

Paul Roberts | 772/260-9591 | [res1977@bellsouth.net](mailto:res1977@bellsouth.net)

**Codes:** 00400, 55490, 86130

## Rohde & Schwarz USA, Inc.

Columbia, MD | <https://www.rohde-schwarz.com/qps>

Jim Allen | 408/679-1329 | [jim.allen@rsa.rohde-schwarz.com](mailto:jim.allen@rsa.rohde-schwarz.com)

**Codes:** 75600, 75850

## Rosemount Nuclear Instruments, Inc.

Chanhassen, MN | [www.emerson.com/rosemountnuclear](http://www.emerson.com/rosemountnuclear)

Tanner Clink | 952/949-5200 | [rnii.info@emerson.com](mailto:rnii.info@emerson.com)

**Stamps:** 10CFR50 Appendix B, 10CFR 21, ISO 9001-2015, NQA-1-1994, KTA 1401, CSA CAN3-Z299.1-85, IAEA 50-C-Q, IAEA GS-R-3

**Codes:** 25000, 69600, 86970\*

## Rousselet-Robatel

Pittsfield, MA | [www.rr-centrifuge.com](http://www.rr-centrifuge.com)

Greg Cybulski | 413/499-4818 | [greg.cybulski@rr-centrifuge.com](mailto:greg.cybulski@rr-centrifuge.com)

**Codes:** 11600, 14300, 24170, 48050, 68000, 73350, 93040

## S.E. International, Inc.

Summertown, TN | [www.seintl.com](http://www.seintl.com)

Beth Cramer | 931/964-3561 | 800/293-5759 | [radiationinfo@seintl.com](mailto:radiationinfo@seintl.com)

**Codes:** 17950, 37130, 55040, 55060\*

## S&G Enterprises, Inc.

Germantown, WI | [www.ramflat.com](http://www.ramflat.com)

Mark J. Griffith | 262/251-8300 | 800/233-3721 | [info@ramflat.com](mailto:info@ramflat.com)

**Codes:** 11680, 11700, 48050, 68000, 93040\*

## S&K Logistics Services

Byron, GA | <https://www.sklogisticservices.com/>

Swaine Skeen | 970/210-4812 | [jskeen@skls-llc.com](mailto:jskeen@skls-llc.com)

**Codes:** 14000, 20300, 25400, 93040

## Sarens Nuclear & Industrial Services LLC (Sarens)

Houston, TX | <https://www.sarens.com/>

Sharon Ferruccio | 770/328-6910 | [sharon.ferruccio@sarens.com](mailto:sharon.ferruccio@sarens.com)

Michael Franzen | 414/850-7707 | [michael.franzen@sarens.com](mailto:michael.franzen@sarens.com)

**Stamps:** ISO 9001:2015 Expiration Date: 12/31/2026; ISO 14001:2015 Expiration Date: 12/31/2026; ISO 45001:2018 Expiration Date: 12/31/2026

**Codes:** 13850, 14000, 14300, 18600, 20300, 38000, 47400, 54300, 73570, 80730, 81680, 87000, 92300



# Directory of Suppliers

## SCH-SOR

### Schaefer Electronics, Inc.

Hopkinton, MA | [www.schaeferpower.com](http://www.schaeferpower.com)  
Sue Mayrand | 508/435-6400 | [smayrand@schaeferpower.com](mailto:smayrand@schaeferpower.com)  
**Codes:** 07070, 41450, 63400\*

### Schulz Electric, Timken Power Systems

East Haven, CT | [www.schulzelectric.com](http://www.schulzelectric.com)  
Josh Rogers | 203/619-1549 | [j.rogers@schulzelectric.com](mailto:j.rogers@schulzelectric.com)  
Matt Radulski | 203/859-7430 | 800/826-1425 | [mattr@schulzelectric.com](mailto:mattr@schulzelectric.com)  
**Stamps:** QA Program: 10CFR50 App. B, NQA 1-2008/2009a, successful audits to CSA Z299 requirements; certification to ISO 9001:2015.  
**Codes:** 03800, 07100, 07120, 08400, 08800, 14000, 14950, 18600, 20350, 24000, 24300, 33500, 35800, 37200, 37700, 40900, 41100, 41450, 46950, 47400, 49000, 49700, 55300, 56600, 79740, 81680, 84150, 84600, 90250, 93750, 93900, 95900\*

### Schutte and Koerting

See advertisement on page 120  
Trevose, PA | [www.s-k.com](http://www.s-k.com)  
Power Sales | 215/639-0900 | [sales@s-k.com](mailto:sales@s-k.com)  
**Stamps:** ASME Section VIII, ANSI B16.34 & B16.5, API 611 & 612, NEMA SM23/24  
**Codes:** 21200, 24250, 24270, 64750, 90100, 90600, 90800, 91260, 91380, 92150

### Scientific Sales, Inc.

Oak Ridge, TN | [www.scisale.com](http://www.scisale.com)  
Wendi Arnold | 865/483-9332  
Amy Underwood | 865/483-9332 | [bd@scisale.com](mailto:bd@scisale.com)  
**Stamps:** WOSB, MBE, TSMSDC  
**Codes:** 02870, 04000, 06870, 07040, 07070, 07100, 07120, 07800, 08400, 09750, 09870, 10780, 10850, 10900, 11650, 13400, 14300, 17950, 20350, 21400, 25250, 26550, 26600, 26900, 31400, 32250, 33200, 33400, 36000, 37130, 37160, 40050, 45550, 47630, 47650, 47670, 47900, 54750, 55040, 55060, 57600, 63400, 73550, 77000, 79360, 79370, 79850, 81790, 83110, 83120, 83210, 86130, 86200\*

### Seafab Metals Co. (Div. of The Doe Run Co.)

Casa Grande, AZ | [www.seafab.com](http://www.seafab.com)  
Joe Snodgrass | [jsnodgrass@seafab.com](mailto:jsnodgrass@seafab.com)  
**Stamps:** NQA-1 audited  
**Codes:** 14300, 59800, 77800

### SecurMAR, LLC

Zionsville, IN | [www.securmar.com](http://www.securmar.com)  
Cindy C. Harts | 219/661-8964 | [charts@securmar.com](mailto:charts@securmar.com)  
Kristin M. Harts | 219/661-8964 | [kharts@securmar.com](mailto:kharts@securmar.com)  
**Codes:** 21500, 22800, 75700, 75850

### SERCO USA

Evergreen, CO | [www.serco-tools.com](http://www.serco-tools.com)  
Nadia Reicher | 303/955-4862 | [contact@serco-tools.com](mailto:contact@serco-tools.com)  
Matthew Wheeler | 303/955-4862 | [contact@protemusa.com](mailto:contact@protemusa.com)  
**Stamps:** EDF UTO 114, CEFRI E  
**Codes:** 08800, 24000, 26230, 28500, 44070, 46950, 47400, 59850, 64120, 72300, 90280, 90320

### SGS North America Inc.

Vallejo, CA | <https://www.sgs.com/en/services/oil-condition-monitoring-ocm>  
Kristen Credille | 707/554-4611 | 800/645-5227 | [kristen.credille@sgs.com](mailto:kristen.credille@sgs.com)  
**Stamps:** ISO 9001; ISO/IEC 17025; 10CFR50 Appendix B  
**Codes:** 39300, 39400, 74150, 84600, 86300

### J. L. Shepherd & Assoc.

San Fernando, CA | [www.jlshepherd.com](http://www.jlshepherd.com)  
Diana Shepherd | 818/898-2361 | [tech@jlshepherd.com](mailto:tech@jlshepherd.com)  
**Stamps:** Certification by USNRC-QA Program-10CFR71, Subpart H, ANSI/ASME NQA-1.  
**Codes:** 09750, 14000, 14300, 37130, 38600, 42600, 42800, 50250, 56460, 68950, 73790, 77750, 77800, 84600, 93040

### Sidus Solutions LLC

San Diego, CA | [www.sidus-solutions.com](http://www.sidus-solutions.com)  
Patricia Barker | 206/376-9542 | 619/275-5533 | [patricia\\_barker@sidus-solutions.com](mailto:patricia_barker@sidus-solutions.com)  
**Stamps:** SDVOSB #: 222120, DVBE: 35907, ISO 9000  
**Codes:** 08800, 14000, 45550, 54750, 72300, 73300, 75850, 83600, 92800, 93040

### Sigma Science, Inc.

Albuquerque, NM | [www.sigmasci.com](http://www.sigmasci.com)  
Robyn Bryant | 630/624-0438 | [rbryant@sigmasci.com](mailto:rbryant@sigmasci.com)  
Carol L. Smith | 505/492-2257 | [csmith@sigmasci.com](mailto:csmith@sigmasci.com)  
**Codes:** 03800, 06860, 14000, 20300, 28150, 37200, 93040

### SimGenics Simulation Systems LLC

Southlake, TX | <https://simgenics.com/>  
Francois Laubscher | 970/261-2070 | [flaubscher@simgenics.com](mailto:flaubscher@simgenics.com)  
**Codes:** 12800, 86300, 86500\*

### Skolnik Industries

Chicago, IL | [www.skolnik.com](http://www.skolnik.com)  
Dean Ricker | 773/735-0700 | 800/441-8780 | [dean@skolnik.com](mailto:dean@skolnik.com)  
**Codes:** 14300, 68000

### Skydio

San Mateo, CA | [www.skydio.com](http://www.skydio.com)  
Matt Chandler | 315/778-2183 | [matt.chandler@skydio.com](mailto:matt.chandler@skydio.com)  
**Codes:** 73300

### Howard L. Sobel, P.E.

Oceanside, NY  
Howard L. Sobel | 516/713-6642 | [hlsobelpe@aol.com](mailto:hlsobelpe@aol.com)  
**Codes:** 03800, 06860, 12750, 12800, 14000, 30600, 30700, 37200, 40900, 66200, 86300

### Solestiss

Kennebunkport, ME | <https://solestiss.com/>  
Brooke Morrison | [brookemorrison@solestiss.com](mailto:brookemorrison@solestiss.com)  
**Stamps:** Women-owned small business  
**Codes:** 14000

### Sonic Systems International, LLC

Houston, TX | [www.sonicsystems.com](http://www.sonicsystems.com)  
Bruce Schlueter | 281/531-7611 | 800/417-3140 | [bschlueter@sonicsystems.com](mailto:bschlueter@sonicsystems.com)  
**Codes:** 06860, 14000, 20300, 25400, 30500, 40900, 56600, 56750, 71700, 80730, 84600, 86300

### SOR Inc.

Lenexa, KS | [www.sorinc.com](http://www.sorinc.com)  
Michelle Herl | 913/888-2630 | 800/676-6794 | [sornuclear@sorinc.com](mailto:sornuclear@sorinc.com)  
**Stamps:** NUPIC & NIAC Audited - 10CFR50 Appendix B, 10CFR Part 21 & NQA-1, CSA B51 Category Type F Class 6 - Press, DP, Temp, & Vac 1E qualified products - ISO 9001 for non-qualified products  
**Codes:** 03200, 25000, 82950\*





### Southwest Research Institute

San Antonio, TX | [www.swri.org](http://www.swri.org)

Business Inquiries | 210/522-2122 | [ask@swri.org](mailto:ask@swri.org)

**Stamps:** SNT-TC-1A, ISO-9001:2015, ISO-17025, ISO-17020, ISO/IEC 17025:2017, NELAC, 10 CFR Part 50 App. B, 10 CFR Part 21, NQA-1, 10 CFR Part 71 Subpart H

**Codes:** 03800, 06860, 09800, 11400, 12720, 12800, 12900, 14000, 19280, 19700, 25600, 28000, 28150, 37200, 39300, 39400, 40900, 42600, 56600, 64312, 72300, 73620, 75600, 77750, 84150, 84600, 86300, 86500, 93040

### SSM Industries, Inc. (Nuclear Div.)

See advertisement on page 57

Pittsburgh, PA | [www.ssmi.biz](http://www.ssmi.biz)

Matt Gorman | 412/777-5101 | [mgorman@ssmi.biz](mailto:mgorman@ssmi.biz)

**Stamps:** ASME R, S, U; ASME AG-1; ASME NQA-1

**Codes:** 03000, 03800, 07800, 13700, 14000, 18400, 19450, 24000, 27150, 27180, 28400, 31400, 32250, 36000, 43700, 47400, 49000, 55300, 60100, 60900, 79740, 82250, 83150, 90250, 90800

### Standish Technologies International

Export, PA | [www.standtech.com](http://www.standtech.com)

Barry Cooney | 724/553-8063 | [barryc@standtech.com](mailto:barryc@standtech.com)

**Codes:** 12750, 14000, 20300, 37200, 81680

### Staplex - Air Sampler Div.

Brooklyn, NY | [www.staplex.com](http://www.staplex.com)

Phil Reed | 718/768-3333 | 800/221-0822 | [info@staplex.com](mailto:info@staplex.com)

**Codes:** 55040, 74150\*

### Strategic Packaging Systems (I.C.E. Packaging Company, LLC)

See advertisement on page 53

Madisonville, TN | [www.spsonline.biz](http://www.spsonline.biz)

Rebekah Moreland | 423/545-9505 | [r.moreland@spsonline.biz](mailto:r.moreland@spsonline.biz)

**Stamps:** NQA-1, SBA HUBZone Certified

**Codes:** 14000, 14300, 20300, 20350, 25600, 26500, 64300, 68000, 77750, 77800, 79360, 87000, 93040

### Struthers-Dunn, LLC

Timmonsville, SC | [www.struthers-dunn.com](http://www.struthers-dunn.com)

David Mioduski | 843/346-4433 | [dmioduski@struthers-dunn.com](mailto:dmioduski@struthers-dunn.com)

**Stamps:** Class 1E, IEEE 323-1983 (Standard for Class 1E Equipment), IEEE 344-1975 (Seismic qualification ANSI/IEEE C3798), ISO 9001:2005

**Codes:** 24300, 82950\*

### Studsvik Scandpower Inc.

Wilmington, NC | [www.studsvik.com/ssp](http://www.studsvik.com/ssp)

Keith Drudy | 412/726-3212 | [keith.drudy@studsvik.com](mailto:keith.drudy@studsvik.com)

Melanie Joseph | 412/605-8467 | [melanie.joseph@studsvik.com](mailto:melanie.joseph@studsvik.com)

**Codes:** 03800, 12800, 86300

### Success Staging International, LLC

Evans, GA | [www.successtaging.com](http://www.successtaging.com)

William (Bill) Jackson | 706/250-4603 | 706/495-6466 | [bill.jackson@successtaging.com](mailto:bill.jackson@successtaging.com)

Gary Fitzpatrick | 706/250-4603 | 913/522-3680 | [gary.fitzpatrick@successtaging.com](mailto:gary.fitzpatrick@successtaging.com)

**Codes:** 06860, 12720, 12750, 12800, 13850, 14000, 86300, 86500

### Sulzer Pumps (US) Inc.

Chattanooga, TN | [www.sulzer.com](http://www.sulzer.com)

Michael Staab | 630/383-6093 | 423/296-1919 | [spusunuclearffq@sulzer.com](mailto:spusunuclearffq@sulzer.com)

Julie Thompson | 423/290-8511 | 423/296-1919 | [julie.thompson@sulzer.com](mailto:julie.thompson@sulzer.com)

**Stamps:** Certified and Compliant to US Nuclear Industry Regulations and Standards, NUPIC, NIAC, and ASME audited; ASME Section III, Class 1, 2, 3 Design and manufacturing responsibility; ASME N certification mark N-2614; ASME NPT certification mark N-2615; 10CFR50 Appendix B Quality Program; 10CFR21 compliant; ANSI N45.2, NQA-1

**Codes:** 64700, 75190

### Super Radiator Coils

See advertisement on page 77

Chaska, MN | [www.superradiatorcoils.com](http://www.superradiatorcoils.com)

Dave Bunce | 952/556-3314 | 952/239-8713 | [dave.bunce@superradiatorcoils.com](mailto:dave.bunce@superradiatorcoils.com)

**Stamps:** ASME N, NPT & NS (Class 2 & 3); ASME U & UM; National Board R; ISO 9000:2015

**Codes:** 03000, 37600, 73950, 77700, 81790, 87950, 92300

### Superconductivity Innovations

New Windsor, NY | [superconductivityinnovations.com](http://superconductivityinnovations.com)

Edward F. Davis, P.E. | 845/567-6070 | 845/764-2373 | [edwardfdavis@supconinn.com](mailto:edwardfdavis@supconinn.com)

**Codes:** 01300, 03800, 14000

### System One

See advertisement on page 65

Pittsburgh, PA | [www.systemone.com](http://www.systemone.com)

Mark Fenske | 412/995-1912 | 877/505-SYS1(7971) | [marketing@systemoneservices.com](mailto:marketing@systemoneservices.com)

**Codes:** 14000, 23850, 25400, 40900, 56600, 66200, 84600, 86300

### T&T Enterprises

See advertisement on page 69

Corona, CA | [www.ttenterprises.com](http://www.ttenterprises.com)

Brent Thalasin | 951/340-0911 | [brent@ttenterprises.com](mailto:brent@ttenterprises.com)

**Codes:** 07330, 07340, 26900, 46950

### Tech Products, Inc.

Staten Island, NY | [www.techproducts.com](http://www.techproducts.com)

Daniel D. O'Connor | 718/442-4900 | 800/221-1311 | [doconnor@techproducts.com](mailto:doconnor@techproducts.com)

**Codes:** 09400, 37130, 47630, 47670, 83110, 83120\*

### Technetics Group Columbia (an EnPro Company)

Columbia, SC | [www.techneticsgroup.com](http://www.techneticsgroup.com)

Ashley Deese | 803/695-3553 | [ashley.deese@technetics.com](mailto:ashley.deese@technetics.com)

**Codes:** 75190\*

### Technical Associates (a Div. of US Nuclear Corp.)

Canoga Park, CA | [www.tech-associates.com](http://www.tech-associates.com)

Sahil Buojiwani | 562/565-4519 | [sahil@usnuclearcorp.com](mailto:sahil@usnuclearcorp.com)

**Codes:** 03800, 04000, 09800, 12800, 17950, 18400, 25250, 26080, 26230, 37130, 55040, 55060, 55470, 67380, 69130, 69140, 69600, 74150, 84150, 93040

### Technical Management Services, Inc.

New Hartford, CT | [www.tmscourses.com](http://www.tmscourses.com)

Robin Rivard | 860/738-2440 | [rrivard@tmscourses.com](mailto:rrivard@tmscourses.com)

**Codes:** 37200, 86400, 86500

### Technisonic Research Inc.

Fairfield, CT

Tony Ruiz | 203/368-3600 | 800/854-7604 | [tonyr@technisonic.net](mailto:tonyr@technisonic.net)

**Codes:** 56600\*



# Directory of Suppliers

## TEC-TRA

### Technology for Energy Corp.

Knoxville, TN | [www.tecnuclear.com](http://www.tecnuclear.com)  
Hailey Soto | 865/966-5856 | [hailey.soto@tec-usa.com](mailto:hailey.soto@tec-usa.com)  
**Stamps:** ISO 9001:2015 Registered.  
**Codes:** 03200, 21270, 22200, 40050, 56600, 91260

### Teledyne Brown Engineering, Inc.

Huntsville, AL | [www.tbe.com](http://www.tbe.com)  
Jessica Sanders | 256/726-1385 | [jessica.sanders@teledyne.com](mailto:jessica.sanders@teledyne.com)  
**Stamps:** ASME N, NPT, U, UM, NS, The National Board of Boilers and Pressure Vessel Inspectors R Certificate/Stamp.  
**Codes:** 03800, 04000, 08800, 09100, 12800, 13400, 14000, 14300, 14950, 20300, 26080, 26100, 26910, 28400, 32250, 36000, 37200, 37600, 38440, 46950, 47400, 49000, 54750, 58250, 59850, 60900, 66200, 66280, 71100, 73620, 74150, 77700, 84150, 84600, 87700, 89650, 92300, 93040\*

### Temp-Pro Inc.

Northampton, MA | [www.temp-pro.com](http://www.temp-pro.com)  
Neal Messier | 413/584-3165 x228 | 800/991-9093 | [neal.messier@temp-pro.com](mailto:neal.messier@temp-pro.com)  
Nicole Chotain | 413/584-3165 | [nchotain@temp-pro.com](mailto:nchotain@temp-pro.com)  
**Stamps:** ISO 9001:2015; ASME Section IX (Boiler & Pressure Vessel Code)  
**Codes:** 13400, 14950, 22150, 24300, 25000, 54750, 69600, 77250, 84150, 85000, 85700\*

### TerranearPMC, LLC

Exton, PA | [www.terranearpmc.com](http://www.terranearpmc.com)  
Dustin G. Miller | 314/240-0507 | [dmiller@terranearpmc.com](mailto:dmiller@terranearpmc.com)  
**Codes:** 03800, 14000, 20300, 37200, 93040

### Tetra Tech Inc.

Richland, WA | [www.tetratetech.com](http://www.tetratetech.com)  
John Gonsky | 509/539-5563 | [john.gonsky@tetratetech.com](mailto:john.gonsky@tetratetech.com)  
Matthew Neuman | 814/952-0393 | [matthew.neuman@tetratetech.com](mailto:matthew.neuman@tetratetech.com)  
**Codes:** 03800, 06790, 06860, 12750, 13850, 14000, 20300, 20350, 26100, 37200, 40900, 44000, 57000, 66200, 73450, 75600, 75850, 77750, 81710, 86300, 93040

### Thermal Engineering International (TEI)

See advertisement on page 78  
Cerritos, CA | <https://www.babcockpower.com/tei/>  
Jennifer Pasquariello | 508/439-0146 | [jpasquariello@babcockpower.com](mailto:jpasquariello@babcockpower.com)  
**Codes:** 03800, 13200, 14000, 21200, 37600, 38000, 47400, 54300, 56600, 61570, 73620, 75190, 77700, 82800, 84600, 86300, 92300

### Thermo Scientific - CIDTEC Cameras & Imagers (Part of Thermo Fisher Scientific)

See advertisement on page 111  
Liverpool, NY | [www.thermofisher.com/cidtec](http://www.thermofisher.com/cidtec)  
Tony Chapman | 315/451-9410 | 800/888-8761 | [sales.cidtec@thermo.com](mailto:sales.cidtec@thermo.com)  
**Codes:** 21270, 39960, 40900, 70650, 73300, 75850, 83600, 92800\*

### THERMOCOAX Inc.

Alpharetta, GA | [www.thermocoax-nuclear.com](http://www.thermocoax-nuclear.com)  
Georges Helleux | 678/947-5510 | [georges.helleux@thermocoax.com](mailto:georges.helleux@thermocoax.com)  
**Codes:** 00400, 08800, 13400, 16000, 17950, 21270, 21500, 22150, 37700, 37800, 54750, 55490, 56400, 58250, 69600, 70670, 77250, 84150, 85000, 85200, 85700, 86750, 95900

### Theseus Quality Assurance, LLC

Richland, WA | [www.infotechnorthstar.com](http://www.infotechnorthstar.com)  
Nolan Wright | 833/538-8880 | [nolan.wright@theseusqa.com](mailto:nolan.wright@theseusqa.com)  
**Stamps:** NIAC, P.E.s on staff  
**Codes:** 03800, 06860, 12720, 12750, 12800, 14000, 19280, 86500

### Thinklogical, A Belden Brand

Milford, CT | <https://www.thinklogical.com/critical-infrastructure/#energy-utilities>  
Thinklogical Sales Department | 203/647-8700 | 800/291-3211 | [info@thinklogical.com](mailto:info@thinklogical.com)  
**Codes:** 09100, 12900, 13600, 14950, 15200, 31650\*

### Tioga Pipe

Philadelphia, PA | [www.tiogapipe.com](http://www.tiogapipe.com)  
Glenn Reigel | 215/831-0700 | 800/523-3678 | [greigel@tiogapipe.com](mailto:greigel@tiogapipe.com)  
Ray Quenzer | 215/266-5752 | [rquenzer@tiogapipe.com](mailto:rquenzer@tiogapipe.com)  
**Stamps:** ASME QSC 467; Classes 1, 2, 3 MC. Certification to ISO 9001:2015, 10CFR50, App. B., NQA-1, MIL-I-45208A Level 1.  
**Codes:** 07330, 07340, 13700, 18400, 26410, 26900, 28390, 28400, 28410, 28530, 28550, 36850, 37780, 49000, 50350, 59800, 59820, 60100, 73730, 77700, 77830, 79740, 82250, 85700, 87950, 88000, 88100, 93800

### TLG Services, LLC (sub. of Entergy Corp.)

Bridgewater, CT | [www.tlgservices.com](http://www.tlgservices.com)  
Lisa Renkowsky | 860/355-2300 | [renkowsky@tlgservices.com](mailto:renkowsky@tlgservices.com)  
**Codes:** 03800, 14000, 20300, 37200, 86300

### TMMC (Toxco Materials Management Center)

Oak Ridge, TN | [toxcommc.com](http://toxcommc.com)  
Alan Duff | 865/482-5532 | 865/207-5678 | [aduff@toxcommc.com](mailto:aduff@toxcommc.com)  
**Codes:** 93040

### Toshiba America Energy Systems Corp.

West Allis, WI | [www.toshiba.com/taes](http://www.toshiba.com/taes)  
Jeffrey Simmons | 414/475-2800 | [jeffry.simmons@toshiba.com](mailto:jeffry.simmons@toshiba.com)  
**Stamps:** ISO 9001:2015  
**Codes:** 01300, 03000, 03180, 03200, 03300, 03500, 03800, 04000, 07040, 09880, 10780, 11400, 12750, 12800, 12900, 13220, 13400, 13600, 13850, 14000, 14300, 14810, 14950, 15200, 15600, 16000, 17200, 17950, 18600, 19700, 20300, 20350, 21270, 23850, 24000, 24300, 25250, 27450, 28300, 29900, 30500, 32250, 34200, 39650, 40900, 41450, 41700, 42400, 47200, 47400, 49000, 50000, 54300, 55040, 55060, 55300, 55470, 56400, 56600, 56900, 58250, 59800, 60450, 60900, 63000, 63400, 64700, 64750, 66280, 68000, 69600, 70600, 70650, 72300, 73300, 73450, 73620, 74150, 76600, 77250, 77700, 78400, 79360, 80600, 80730, 80800, 81000, 82250, 84150, 84600, 86130, 86300, 86750, 89400, 89500, 89510, 90250, 90280, 90320, 90330, 90600, 90800, 91380, 93240, 93750

### Tower Performance LLC

Houston, TX | [www.towerperformance.com](http://www.towerperformance.com)  
Jalene Fritz | 970/593-8637 | 800/314-1695 | [jfritz@towerperformance.com](mailto:jfritz@towerperformance.com)  
**Codes:** 86200\*

### TradeWind Services LLC

Richland, WA | [www.tradewindllc.com](http://www.tradewindllc.com)  
Ericka Rice | 509/943-4745 | [erickar@tradewindllc.com](mailto:erickar@tradewindllc.com)  
John-Paul Blair | 509/943-4745 | 206/715-8934 | [jpbblair@tradewindllc.com](mailto:jpbblair@tradewindllc.com)  
**Codes:** 12720, 12750, 12800, 13850, 14000, 25400, 28150, 37200

### Transco Products Inc.

Streator, IL | [www.transcoproducts.com](http://www.transcoproducts.com)  
Kevin Hawks | 312/896-8501 | [kevinh@transcoproducts.com](mailto:kevinh@transcoproducts.com)  
**Stamps:** NUPIC Audited 10CFR50 App. B Safety Related Quality Assurance Program, ISO 9001:2008 Certified  
**Codes:** 14000, 14300, 26230, 28150, 37130, 39960, 41200, 44090, 47400, 64750, 68800, 68900, 77750, 77800, 81790, 84600, 86300, 93040

### TransWare Enterprises Inc.

St. Louis, MO | [www.transware.net](http://www.transware.net)  
Dean B. Jones | 815/762-7121 | 815/762-2287 | [dean.jones@transware.net](mailto:dean.jones@transware.net)  
**Codes:** 03800, 12800, 14000, 55500, 73450, 77750, 81680, 86300, 93040



## Tri Nuclear Corp.

Troy, NY | www.trinuclear.com

Rick Russell | 518/399-1389 | rick@trinuclear.com

**Codes:** 10780, 27150, 27180, 27450, 41700, 49000, 50250, 68000, 70650, 72300, 77800, 83150, 86300, 90100, 93500

## Trillium Flow Technologies (Atwood & Morrill, Batley, Blakeborough, Hiller, Hopkinsons, Red Point, SARASIN-RSBD, SEBIM, Termomeccanica Pompe, Tricentric)

Houston, TX | www.trilliumflow.com

Julia Henning | 978/825-2594 | 978/744-5690 | julia.henning@trilliumflow.com

**Stamps:** N, NPT, NV, ASME III, Class 1, 2, & 3; Certification by ISO 9001.

**Codes:** 84150, 90600, 90800, 91000, 91260, 91380

## Tru-Motion Products, LLC

Cheyenne, WY | www.trumotionproducts.com

Anthony Suneson | 704/982-9242 | info@trumotionproducts.com

**Codes:** 47600

## Trust Manufacturing, LLC

Euclid, OH | www.trustmfg.com

Sean Stapulionis | 216/531-8787 | sean@trustmfg.com

Ken Marvar | 440/479-4708 | kmarvar@trustmfg.com

**Stamps:** ASME Section III QSC-594, 10CFR50 App. B, NQA-1

**Codes:** 07330, 07340, 13700, 14000, 18400, 26900, 28390, 28400, 28530, 46950, 50350, 60100, 61570, 79740, 82250

## TSSD Services, Inc.

Sidney, ME | tssdservices.com

Jennifer Wood | 877/965-8773 x2 | jwood@tssdservices.com

**Codes:** 14000, 20300, 25400

## TW Metals - Nuclear Materials Solutions

Linden, MI | www.twmetals.com

Dean A. Gannon | 724/251-4702 | 800/924-2171 | dean.gannon@twmetals.com

Al Valentine | 810/394-0181 | 800/924-2171 | al.valentine@twmetals.com

**Stamps:** ASME QSC-597

**Codes:** 07330, 07340, 13700, 14300, 18400, 18600, 26900, 28390, 28400, 28410, 28530, 28550, 36850, 37600, 49000, 50300, 50350, 56750, 59800, 59850, 61570, 66280, 77700, 77830, 80730, 83150, 87700, 87950, 88000, 88100, 92300, 93800

## Tyne USA Inc.

Jacksonville, FL | www.tyneusa.com

Kim Kershner | 877/969-8963 | kim.kershner@tyneusa.com

**Codes:** 00400, 03200, 03550, 04000, 09750, 09800, 14000, 14950, 17950, 21270, 21400, 25250, 31700, 36000, 37130, 40050, 42600, 42800, 47400, 54750, 55040, 55060, 64190, 64750, 67380, 69600, 71900, 75190, 77700, 82950, 84430, 86970, 87380, 87395, 87400, 90800, 91260, 92300\*

## U.S. Bellows, Inc. (Sub. of Piping Technology & Products, Inc.)

Houston, TX | www.usbellows.com

Randy Bailey | 713/731-0030 | 800/787-5914 | sales@usbellows.com

**Codes:** 07200, 43700

## Ultra Energy (Weed Instrument)

See advertisement on page 98

Round Rock, TX | www.ultra.energy

Bruce Weir (US) | 512/434-2800 | sales@ultra-nspi.com

Neil Clarke (UK) | +44 0 7703 751850 | +44 1202 850 450 | sales@ultra-ncs.com

**Codes:** 03800, 04000, 06820, 08800, 09100, 12720, 12750, 12800, 14000, 14950, 15600, 17950, 19280, 19700, 22150, 26970, 37130, 47400, 55040, 56400, 69600, 77250, 84150, 84600, 85700, 86750

## Underwater Construction Corp. (Underwater Construction Corp. UK Ltd.)

See advertisement on page 15

Essex, CT | www.ucdive.com

Phil McDermott | 800/USA-DIVE | pmcdermott@ucdive.com

**Stamps:** ASTM D33 Member, NIAC Member since 1996, ADCI Member, AWS Member, NACE and ASME Certified Inspectors.

**Codes:** 20300, 22700, 40900, 45700, 47400, 47600, 56600, 66280, 72300, 90100, 92800, 93040, 93220, 93750, 93900\*

## UniTech Services Group, Inc. (Div. of UniFirst Corp.)

See advertisements on pages 40 and 75

Longmeadow, MA | www.unitechus.com

Victor Crusselle | 413/543-6911 x118 | vcrusselle@unitechus.com

**Codes:** 10780, 10850, 10900, 14300, 20300, 20350, 25400, 26230, 26550, 37130, 37200, 55040, 55060, 56750, 68000, 73550, 74150, 86260, 93040, 95850\*

## United Engineers & Constructors, Inc. (Sub. of Imperia Engineering Partners)

Mount Laurel, NJ | www.ueci.com

Scott Reeder | 856/348-5427 | scott.reeder@ueci.com

Art Lembo | 609/865-9502 | art.lembo@ueci.com

**Codes:** 13850, 14000, 28150, 75600

## Urenco USA (UUSA)

See advertisement on page 119

Eunice, NM | www.urencousa.com

Lisa Hardison | 575/394-6099 | lisa.hardison@urencousa.com

**Codes:** 89650

## US Nuclear Corp. (Technical Associates Sub.), (Overhoff Technology Corp. Sub.)

Canoga Park, CA | www.tech-associates.com and www.overhoff.com and www.usnuclearcorp.com

Sahil Bhojwani | 562/565-4519 | sahil@usnuclearcorp.com

**Codes:** 03200, 04000, 09750, 09800, 17950, 21270, 21300, 24400, 26080, 35650, 37130, 37200, 39960, 55040, 55060, 56400, 67380, 69130, 69140, 69600, 73900, 74150, 74400\*

## Utilities Service Alliance (USA)

Overland Park, KS | www.usainc.org

Jim Kitchens | 913/905-9266 | jkitchens@usainc.org

**Codes:** 14000

## UxC, LLC

Roswell, GA | www.uxc.com

Eric Webb | 770/642-7745 | eric.webb@uxc.com

**Codes:** 03800, 12800, 14000, 30600, 30700, 40700, 50300, 70600, 70900, 73400, 73450, 81680, 81710, 86300, 89590, 89600, 89650, 89760, 89795, 89800\*

## Val-Matic Valve & Mfg. Corp.

Elmhurst, IL | www.valmatic.com

**Stamps:** Certification by ISO 9001:2015.

**Codes:** 90000, 90250, 90600, 91260\*

## Valcor Engineering Corp. (Valcor Nuclear Div.)

See advertisement on page 122

Springfield, NJ | www.valcor.com

Thien Nguyen | 973/467-8400 | nuclear@valcor.com

**Stamps:** N, NPT, Classes 1, 2, 3. Certification by ANSI N45.2 App. B 10CFR50; ISO 9001; HAF 604.

**Codes:** 47400, 57050, 71900, 84150, 90250, 90600, 90800, 91260, 92150



# Directory of Suppliers

## VAL-WMG

### Valiant Products, Inc.

Lakeland, FL | [valiantproductsinc.com](http://valiantproductsinc.com)

Bob English | 863/688-7998 | [renglish@valiantproductsinc.com](mailto:renglish@valiantproductsinc.com)

**Codes:** 43700

### ValvTechnologies

Houston, TX | [www.valv.com](http://www.valv.com)

Cesar Mejia | 713/860-0480 | 713/898-3717 | [cmejia@valv.com](mailto:cmejia@valv.com)

Ben Jones | 205/725-9407 | [bjones@valv.com](mailto:bjones@valv.com)

**Stamps:** ASME N Stamp Authorization for Class 1, 2 & 3 valves, NPT Stamp Authorization for nuclear grade parts, ANSI N45.2, 10CFR50 App. B, 10CFR Part 21 Acceptance, NQA-1

**Codes:** 91380

### VAT Group

San Jose, CA | [www.vatvalve.com](http://www.vatvalve.com)

Stacy Gerrity | 408/375-5567 | [sgerrity@vatvalve.com](mailto:sgerrity@vatvalve.com)

**Codes:** 12750, 12800, 14950, 87000, 90100, 90800, 91000, 91260, 91380\*

### Veolia Nuclear Solutions - Federal Services

Piketon, OH | [www.vnsfederalservices.com](http://www.vnsfederalservices.com)

Amanda Gilmore | 740/443-7141 | [amanda.gilmore@vnsfs.com](mailto:amanda.gilmore@vnsfs.com)

Sean McGraw | 202/746-0260 | [sean.mcgraw@vnsfs.com](mailto:sean.mcgraw@vnsfs.com)

**Codes:** 03000, 03800, 09800, 10780, 13850, 20300, 20350, 20700, 26100, 41700, 47600, 53950, 67380, 68000, 72300, 73620, 79360, 84600, 87380, 87400, 93040

### Volian Enterprises, Inc.

Murrysville, PA | [www.volian.com](http://www.volian.com)

Harold V. Julian | 724/335-3744 | [volianenterprises@volian.com](mailto:volianenterprises@volian.com)

**Codes:** 03800, 12750, 12800, 14000, 41000, 86300, 86500

### Vysus Group

Houston, TX | [www.vysusgroup.com](http://www.vysusgroup.com)

Anders Olsson | + 46 850 240 747 | [anders.olsson@vysusgroup.com](mailto:anders.olsson@vysusgroup.com)

Vishal Lagad | 254/327-0700 | [vishal.lagad@vysusgroup.com](mailto:vishal.lagad@vysusgroup.com)

**Codes:** 14000, 84600

### Wagstaff Applied Technologies

See advertisement on page 74

Spokane, WA | [www.wagstaffat.com](http://www.wagstaffat.com)

Dan Payne | 509/321-3184 | [dan.payne@wagstaff.com](mailto:dan.payne@wagstaff.com)

**Stamps:** ASME U Stamp, ASME NQA-1 2008/2009

**Codes:** 12750, 14300, 20350, 36000, 36850, 37600, 46950, 48950, 49000, 50250, 53950, 60100, 66280, 68000, 72300, 77700, 77750, 77800, 79360, 81710, 83150, 87380, 92300, 93900

### B. E. Wallace Products Corp. (dba Wallace Cranes)

Malvern, PA | [www.wallacecranes.com](http://www.wallacecranes.com)

Bart J. Sunderland | 610/647-1400 | 800/553-5438 | [barts@wallacecranes.com](mailto:barts@wallacecranes.com)

**Codes:** 18600

### Warrington, Inc.

Pflugerville, TX | [www.warringtonusa.com](http://www.warringtonusa.com)

Gary D. Stafford | 512/251-7771 | 800/233-9491 | [info@warringtonusa.com](mailto:info@warringtonusa.com)

**Codes:** 03800, 04000, 06820, 09800, 17950, 41000, 55040, 55060, 93040\*

### Waste Control Specialists LLC

Andrews, TX | [www.wcstexas.com](http://www.wcstexas.com)

Steve Ferguson | 513/560-1744 | [sferguson@wcstexas.com](mailto:sferguson@wcstexas.com)

Dan Davis | 432/556-7357 | [ddavis@wcstexas.com](mailto:ddavis@wcstexas.com)

**Codes:** 14300, 20300, 25600, 87000, 93040

### Waste Control Systems, Inc.

Phoenix, MD | [www.wastecontrol.com](http://www.wastecontrol.com)

William Fannon | 410/252-9360 | 877/252-9360 | [sales@wastecontrol.com](mailto:sales@wastecontrol.com)

**Codes:** 11700, 14300, 68000

### Weldstar

Aurora, IL | [www.weldstar.com](http://www.weldstar.com)

Alex Jackson | 630/849-2430 | [ajackson@weldstar.com](mailto:ajackson@weldstar.com)

**Stamps:** ASME Quality System Certificate 229, ISO 9001:2015 C2020-00612

**Codes:** 10850, 10900, 93800

### Westinghouse Electric Co. LLC

Cranberry Township, PA | [www.westinghousenuclear.com](http://www.westinghousenuclear.com)

Kristofor Paserba | 412/374-4971 | 800/458-2206 | [paserbkr@westinghouse.com](mailto:paserbkr@westinghouse.com)

Varesha Mauney | 508/591-1149 | [varesha.mauney@westinghouse.com](mailto:varesha.mauney@westinghouse.com)

**Codes:** 00400, 03000, 03180, 03200, 03800, 06860, 07100, 07120, 07310, 08400, 08800, 09800, 10010, 10780, 11400, 11600, 11650, 12720, 12750, 12800, 13050, 13400, 13600, 13850, 14000, 14300, 14950, 15200, 15600, 16800, 17950, 18600, 19280, 20300, 20350, 22150, 22200, 22410, 22660, 24300, 25000, 25250, 25300, 25400, 25600, 26080, 26100, 26230, 26900, 26910, 26970, 27450, 29360, 29900, 30000, 30040, 30450, 30500, 30600, 30700, 31650, 32250, 33500, 35800, 36870, 37130, 37200, 37600, 38000, 39300, 39400, 40050, 40900, 41000, 41450, 41700, 46950, 47400, 49000, 49700, 50300, 51850, 54750, 55040, 55300, 55490, 56400, 56600, 56750, 56900, 57600, 58250, 59800, 63400, 63800, 64700, 64750, 66280, 67380, 68000, 69600, 70650, 70900, 71100, 71700, 72300, 73570, 74350, 75190, 75600, 75850, 76400, 77250, 77750, 78400, 79360, 79740, 80600, 80730, 81680, 81710, 82950, 84150, 84600, 85700, 86300, 86500, 86750, 86870, 86970, 88100, 89580, 89600, 90000, 90250, 90330, 90600, 90800, 91000, 91260, 91380, 92800, 93040, 93500, 93800, 93900\*

### Westinghouse Electric Company LLC (Westinghouse Parts Business)

See advertisement on cover 2

New Stanton, PA | [www.westinghousenuclear.com/parts](http://www.westinghousenuclear.com/parts)

Ben Solich | 412/735-5796 | [solichbd@westinghouse.com](mailto:solichbd@westinghouse.com)

Ryan Vanston | 724/766-3874 | [vanstort@westinghouse.com](mailto:vanstort@westinghouse.com)

**Stamps:** ASME Section III Certificates: N, NA, NS and NPT Stamps

**Codes:** 02870, 03000, 03200, 03500, 03550, 03800, 04000, 07040, 07060, 07070, 07080, 07100, 07120, 07200, 07330, 07340, 07800, 08400, 08800, 09100, 09400, 09550, 12100, 13180, 13200, 13220, 13400, 13600, 14000, 14300, 14950, 15300, 15600, 16000, 17950, 18400, 18590, 18600, 19450, 22430, 22660, 22800, 23900, 24000, 24180, 24190, 24300, 24400, 25000, 26240, 26900, 26910, 27450, 28390, 28400, 28410, 28530, 28550, 30500, 33400, 34200, 35800, 36000, 36900, 37600, 37660, 37700, 37720, 37800, 38000, 38200, 38440, 40050, 41015, 41200, 41450, 42870, 43700, 45550, 46810, 46950, 47400, 50300, 50350, 54300, 55300, 56900, 57050, 58250, 59800, 60100, 60150, 61570, 63400, 63800, 64700, 64750, 66280, 69600, 71500, 71900, 72000, 75190, 76400, 76600, 77000, 77250, 77700, 78200, 78400, 79000, 79350, 79740, 80200, 80400, 81790, 82250, 82950, 83150, 83210, 84000, 84100, 84600, 85000, 85700, 86750, 86870, 86970, 87140, 87380, 87395, 87400, 88000, 88100, 88200, 90000, 90250, 90600, 90800, 91000, 91260, 91380, 92300, 95900\*

### Westlake Epoxy Inc., a Westlake Company

Stafford, TX | <https://www.westlakeepoxy.com>

Product Information | 614/986-2484 | [epoxyservice@westlake.com](mailto:epoxyservice@westlake.com)

**Stamps:** Certification by ISO 9000/ISO 9001

**Codes:** 02870, 11400, 17650

### WMG, Inc.

See advertisement on page 5

Peekskill, NY | [www.wmginc.com](http://www.wmginc.com)

Jeff Nelson | 914/736-7100 | [jnelson@wmginc.com](mailto:jnelson@wmginc.com)

**Codes:** 03800, 12750, 12800, 14000, 14300, 17950, 20300, 20350, 30600, 37200, 55500, 68000, 71190, 72300, 77750, 79360, 86300, 86500, 93040



## WTM Valves and Services - Hammel Dahl (Div. of Wright Technical Marketing)

Lewisburg, PA | [www.wrighttechnical.com](http://www.wrighttechnical.com)  
Drew Wright | 570/522-8323 | [dwright@wrighttechnical.com](mailto:dwright@wrighttechnical.com)  
**Codes:** 14000, 90250, 90800, 91260

## Zachry Nuclear Engineering

Charlotte, NC | <http://www.zachrynuclear.com/>  
Bristol Hartlage | 919/653-7657 | 619/888-3439 | [hartlage@numerical.com](mailto:hartlage@numerical.com)  
**Stamps:** 10CFR50 Appendix B, ASME NQA-1  
**Codes:** 03800, 12800, 14000, 20300\*

## Part II—Companies located outside the United States

### Belgium

#### Nuclear-21

Waasmunster | [www.nuclear-21.net](http://www.nuclear-21.net)  
Luc Van Den Durpel | +32 473865647 | [vddurpel@nuclear-21.net](mailto:vddurpel@nuclear-21.net)  
**Codes:** 12750, 12800, 14000, 20300, 20350, 30600, 30700, 62900, 62910, 63000, 68950, 70660, 70665, 70920, 73400, 73450, 73770

### Canada

#### ATS Industrial Automation, Inc. Nuclear (Canada)

Cambridge, Ontario | <https://atsautomation.com/nuclear>  
Paul McKenna | 519/574-5914 | [pmckenna@atsautomation.com](mailto:pmckenna@atsautomation.com)  
**Stamps:** ASME NQA-1; 10CFR50 App. B; 10CFR21 Program; CSA N285.0; CSA N286; CSA N299; CSA B51; ASME B31.1; ASME B31.3; ISO-9001:2015; ISO:13485:2016  
**Codes:** 10780, 11700, 12800, 14000, 20300, 25600, 29900, 30040, 30500, 31700, 40900, 43150, 43400, 47400, 47600, 48050, 59850, 68000, 68950, 70650, 72300, 73300, 73620, 79360, 84000, 86130, 86800, 87380, 87400, 87680, 92800, 93040

#### Bot Engineering Ltd

See advertisement on page 87  
Campbellville, Ontario | [www.bot.engineering](http://www.bot.engineering)  
905/876-4301 (CAN) | 716/304-7041 (US) | [info@botcorp.com](mailto:info@botcorp.com)  
**Codes:** 03550, 04000, 08800, 09750, 12900, 17950, 24400, 25000, 25250, 25300, 26080, 35650, 55040, 55060, 55470, 63800, 69130, 69140, 69600, 73770, 74400

#### Canoil Canada Ltd

Mississauga, Ontario | [www.canoilcanadaltd.com](http://www.canoilcanadaltd.com)  
Allan Murray | 905/536-3154 | 855/520-2022 | [allan@canoilcanadaltd.com](mailto:allan@canoilcanadaltd.com)  
**Codes:** 03800, 46810

#### DB2 Consulting Inc.

Baltimore, Ontario | [www.db2consulting.ca](http://www.db2consulting.ca)  
Doug Burton | 289/251-1105 | [doug@db2consulting.ca](mailto:doug@db2consulting.ca)  
**Codes:** 14000, 46950, 86300

#### E.S. Fox Limited

Niagara Falls, Ontario | [www.esfox.com](http://www.esfox.com)  
Frank Pepers | 905/354-3700 | [frank.pepers@esfox.com](mailto:frank.pepers@esfox.com)  
Anthony DeChellis | 905/354-3700 | [anthony.dechellis@esfox.com](mailto:anthony.dechellis@esfox.com)  
**Stamps:** ASME; Section VIII Div. 1; B31.1; B31.3; Section 3; B31.5; ISO 9001:2015; 14001; 45001; N299 (2, 3, 4) ASME N, NPT, NA, NS, U, U2, S & PP Certifications. Privately owned.  
**Codes:** 02870, 03000, 07800, 13850, 14000, 14300, 20300, 24300, 28400, 28530, 28550, 37600, 37700, 45550, 47400, 48950, 49000, 56600, 56750, 59800, 59820, 60100, 60900, 73570, 80730, 83150, 93750, 93900

#### Eddyfi Technologies

Quebec City, Quebec | [www.eddyfi.com](http://www.eddyfi.com)  
**Codes:** 01300, 03800, 04000, 10780, 12750, 12800, 14000, 19700, 26080, 39960, 47600, 48050, 54750, 55040, 56600, 68000, 70650, 72300, 73300, 73620, 80730, 83600, 84150, 86130

#### FuseRing Inc.

London, Ontario | <https://fusering.com/>  
Paul Cheng | 519/709-2091 | [info@fusering.com](mailto:info@fusering.com)  
Paul Zegwaard | +49 0 160 72 65 527 | [pzegwaard@yahoo.com](mailto:pzegwaard@yahoo.com)  
**Stamps:** ASME IX, code case 2799  
**Codes:** 14300, 30000, 47400, 59800, 81680, 81710, 88100, 93800, 93900

#### Hoskin Scientific

Oakville, Ontario | [www.hoskin.ca](http://www.hoskin.ca)  
Brian Garner | 905/333-5510 | 800/665-5871 | [bgarner@hoskin.ca](mailto:bgarner@hoskin.ca)  
**Codes:** 01300, 03200, 03550, 03800, 04000, 08800, 09750, 09800, 12800, 19700, 84150\*

#### IMI Critical Engineering

Burlington, Ontario | [www.imi-critical.com](http://www.imi-critical.com)  
Sorin Necula | 647/408-8076 | [sorin.necula@imi-critical.com](mailto:sorin.necula@imi-critical.com)  
Bradley Michell | 416/300-4954 | [bradley.michell@imi-critical.com](mailto:bradley.michell@imi-critical.com)  
**Codes:** 90250, 90800, 91000, 91260, 91380

#### Integra Services Technologies Inc.

Sarnia, Ontario | [www.integratetechnologies.com](http://www.integratetechnologies.com)  
David Smith | 519/332-1100 | [dsmith@integratetechnologies.com](mailto:dsmith@integratetechnologies.com)  
**Codes:** 07310, 07340, 14000, 26230, 26390, 39650, 46950, 47400, 56600, 60100, 64750, 70650, 84000, 86130, 96500

#### Kanata Electronic Services Ltd. (Div. of Shawcor Ltd.)

Toronto, Ontario | [www.kesl.com](http://www.kesl.com)  
Barbara Miller | 416/745-0688 | 888/371-5375 | [bmiller@kesl.com](mailto:bmiller@kesl.com)  
**Stamps:** ISO9001:2015  
**Codes:** 08800, 13400, 22150, 40050, 41100, 41200, 58250, 69600, 86750, 86970

#### Kinectrics Inc.

Toronto, Ontario | [www.kinectrics.com](http://www.kinectrics.com)  
Brandon Emrich | 416/207-6000 | [brandon.emrich@kinectrics.com](mailto:brandon.emrich@kinectrics.com)  
**Codes:** 03800, 04000, 06860, 09100, 09750, 09800, 12800, 13400, 13850, 14000, 19280, 20300, 20350, 24300, 26100, 27450, 28400, 37200, 39300, 39400, 44000, 46950, 47400, 54750, 55040, 55300, 56600, 68000, 68950, 73450, 73620, 74320, 76400, 77750, 79370, 79740, 80565, 80730, 84600, 86130, 86300, 87000, 87380, 93040, 93220, 93240



# Directory of Suppliers

## Canada

### L3Harris MAPPS Inc. (Power Systems and Simulation)

Montreal, Quebec | [www.L3Harris.com](http://www.L3Harris.com)

Michael Chatlani | 514/924-3566 | [michael.chatlani@l3harris.com](mailto:michael.chatlani@l3harris.com)

Isabelle Derry | 514/787-4999 | [power.mapps@l3harris.com](mailto:power.mapps@l3harris.com)

**Stamps:** ISO 9001:2015

**Codes:** 12800, 14000, 37200, 40900, 78400, 86300, 86400, 86500

### MarShield Radiation Shielding (Div. of Marswell Metal Industries Ltd.)

Burlington, Ontario | [www.marshield.com](http://www.marshield.com)

Jim Chesla | 905/637-3862 | 800/381-5335 | [jchesla@marsmetal.com](mailto:jchesla@marsmetal.com)

**Stamps:** ISO9001:2015, CSA-N299.3:16 (Canadian Equivalent to NQA1)

**Codes:** 03200, 03800, 06950, 10900, 14000, 14300, 22800, 25600, 30500, 37130, 47400, 49000, 50250, 53950, 55490, 59800, 69600, 77750, 77800, 79360, 93800, 95750\*

### Mirion Technologies (IST Canada) ULC (Formerly Mirion Technologies (IST Canada) Inc.)

Cambridge, Ontario

Rae Watson | 519/497-8340 | [rwatson@mirion.com](mailto:rwatson@mirion.com)

**Codes:** 08800, 17950, 21270, 22150, 51850, 56400, 58250, 63800, 69600, 77250, 85700\*

### Patriot Forge Co.

Brantford, Ontario | <https://www.patriotforge.com/>

Terry Rocha | 519/758-8100 | 877/495-9542 | [terryr@patriotforge.com](mailto:terryr@patriotforge.com)

Robert Dimitrieff | 877/495-9542 | [robertd@patriotforge.com](mailto:robertd@patriotforge.com)

**Codes:** 37780, 39960, 49000

### Power Generation Integrated (PGICL)

Etobicoke, Ontario | <http://powergenerationintegrated.com>

Vinod Chugh | 647/575-9349 | 510/410-5837 | [info@pgicl.ca](mailto:info@pgicl.ca)

**Stamps:** P. Eng. (Canada)

**Codes:** 06860, 14000, 31700, 55040, 62910, 70665, 87380, 87395, 87400

### Pylon Electronics Inc. (Instrument Manufacturing Div.)

Ottawa, Ontario | [www.pylonelectronics-radon.com](http://www.pylonelectronics-radon.com)

Brad Lafrance | 613/226-7920 x1109 | [instrument@pylonelectronics.com](mailto:instrument@pylonelectronics.com)

**Codes:** 03200, 17950, 20500, 21270, 55040, 68950, 74150, 76400, 79850

### REEL COH Inc.

[www.reel-coh.com](http://www.reel-coh.com)

Stephan Bedard | 450/430-6500 | 800/363-6501 | [sbedard@reelcoh.com](mailto:sbedard@reelcoh.com)

**Stamps:** ISO9001:2015, CMAA, AWS, CWB

**Codes:** 03800, 09950, 18590, 18600, 30500, 40900, 47400, 48050

### ROPA Technologies Inc.

Kincardine, Ontario | [www.ropatechnologies.com/](http://www.ropatechnologies.com/)

Larry Fisher | 519/396-8555 | 800/665-2740 | [lfisher@sedtechnologies.com](mailto:lfisher@sedtechnologies.com)

**Codes:** 86300\*

### Special Electronics & Designs Inc. (SED Inc.)

Kincardine, Ontario | [www.sedtechnologies.com](http://www.sedtechnologies.com)

Rolf Eberl | 519/396-8555 | 800/665-2740 | [rolf.eberl@sedtechnologies.com](mailto:rolf.eberl@sedtechnologies.com)

**Codes:** 03000, 03200, 10850, 11650, 14000, 28390, 86300\*

### Sulzer Management Ltd. (Sulzer Pumps (Canada) Inc.)

Burnaby, British Columbia | [www.sulzer.com](http://www.sulzer.com)

Dimitrie Cepisca | 416/213-8800 | 647/338-2705 | [dimitrie.cepisca@sulzer.com](mailto:dimitrie.cepisca@sulzer.com)

**Stamps:** ASME Section III (Cl. 1, 2 & 3); ASME N & NPT certificate of authorization; CSA B51; CSA N285; MIL-Q-9858-A; NDT MPI/LPI/RT/UT; EN 13445; CSA Z299.1/2/3/4; Standard KTA 1401; IAEA 50-C-Q; AVS D 100/50; FRA/N/100/OL3; RCC-M; API 610, ISO 5199, ANSI/ASME B73.1; HAF 601 CL. 3; HAF 604 CL. 2 & 3

**Codes:** 47400, 64700, 64750

### Thorburn Flex Inc.

Pointe-Claire, Quebec | [www.thorburnflex.com](http://www.thorburnflex.com)

John Thorburn | 514/695-8710 | 800/363-6613 | [jthorburn@thorburnflex.com](mailto:jthorburn@thorburnflex.com)

**Stamps:** ISO 9001:2015, ASME NPT Class 1 for Design and Fabrication, ASME Section VIII Div. 1, ASME B31.3, ASME B31.1, N285.0, CSA B51, CSA, CNCAN, CSA N299.1

**Codes:** 07200, 26240, 28390, 38440, 43700, 47400\*

### UCC Industries International Inc.

Pickering, Ontario | [www.ucci.ca](http://www.ucci.ca)

Brent Hughes | 905/831-7724 | 800/308-1043 | [bhughes@ucci.ca](mailto:bhughes@ucci.ca)

**Codes:** 13700, 26900, 28390, 28400, 50250, 50350, 76600, 79740, 88100, 88200

### Velan Inc.

Montreal, Quebec | [www.velan.com](http://www.velan.com)

George Lysakowski | 416/230-6291 | [george.lysakowski@velan.com](mailto:george.lysakowski@velan.com)

**Stamps:** N, NPT, Classes 1, 2, 3. ISO 9001 Certification, LLOYDS, TUV.

**Codes:** 90600, 91000, 91260, 91380

## China

### QingCheng Ltd. (QingCheng AE Institute)

Guangzhou | [www.aendt.com](http://www.aendt.com)

Barry Lee | +86 020 32290092 | [lwm@ae-ndt.com](mailto:lwm@ae-ndt.com)

**Codes:** 56600\*

## Czech Republic (The)

### METOIL

Praha | [www.metoil.com](http://www.metoil.com)

Igor Voinov | +420 774 136 322 | [voinov@metoil.com](mailto:voinov@metoil.com)

**Codes:** 00400, 14000, 68000, 79370, 86300

### SKODA JS a.s.

Plzen, Bolevec | [www.skoda-js.cz](http://www.skoda-js.cz)

Miroslava Karnikova | +420 734 358 535 | [info@skoda-js.cz](mailto:info@skoda-js.cz)

**Stamps:** Certification by ISO 9001, ISO 14001, ISO 45001, AD-Merkblatt HP0, CEFRI

**Codes:** 03800, 13850, 14300, 15600, 17200, 30500, 40900, 47400, 56600, 58250, 69600, 79740, 81710, 84000, 84600, 92300, 93900

## Finland

### Platom Oy

Mikkeli | [www.platom.fi](http://www.platom.fi)

Miika Puukko | +358 44 5504303 | [m.puukko@platom.fi](mailto:m.puukko@platom.fi)

**Codes:** 03800, 06870, 14000, 30500

## France

### 3D PLUS (Detection Systems)

Versailles | [www.3dplus-detection.com](http://www.3dplus-detection.com)

Patrice Benard | +33 607533008 | [marketing@3d-plus.com](mailto:marketing@3d-plus.com)

**Codes:** 12800, 17950, 20300, 25250, 39960, 55040, 68800, 77000\*



## Bertin Technologies

www.bertin-instruments.com

Julien Villert | +33 6 74 53 54 11 | julien.villert@bertin.group

**Stamps:** Certification by ISO 9001.

**Codes:** 03200, 04000, 09750, 09800, 12800, 17950, 25250, 26080, 37130, 37200, 47400, 54750, 55040, 55060, 56400, 67380, 69600, 75850, 86300

## descote

Feyzin | www.descote.com

Jean-Pierre Richer | +33 472 89 25 00 | info@descote.com

**Stamps:** ASME III; RCC-M; AREVA/ORANO Certification; NAQ-1; ISO 9001; QP complying to 10CFR50 app. B, 10CFR21; Regular customer audits; SIL 3 capable

**Codes:** 24270, 90250, 90800, 91260

## EKIUM

Bron Cedex | www.ekium.eu

Christophe Zaia | +33 0632231705 | christophe.zaia@ekium.eu

**Stamps:** ISO-CEFRI-QUALIFOUDRE-ISM ATEX-MASE-ASME-RCCE-RCCM-UTO

**Codes:** 13850, 14000, 25700

## FEVDI Nuclear Decontamination

Corbas | www.fevdi-nuclear.com

Thomas Xu | +33 627053026 | t.xu@fevdi-nuclear.com

**Codes:** 10780, 11400, 14000, 20350, 37160, 57600\*

## KROHNE (KROHNE Nuclear)

Romans-sur-Isère | https://krohne.com/en/industries/nuclear-industry

Géraldine Pierron | +33 698 657 366 | g.pierron@krohne.com

Anke Krueger | +33 475 056 703 | a.krueger@krohne.com

**Stamps:** ASME III N; ASME III NPT; HAF 604; KTA 1401; ISO 9001; ISO 14001; ISO 45001; CSA N299.2; ISO 19443

**Codes:** 03200, 04000, 09750, 09800, 14950, 40050, 57050, 77250, 82950, 86970\*

## Mirion Technologies (Premium Analyse) SAS

Norroy Le Veneur | https://fr.mirion.com/en/premium-analyse

Loic Pierre | +33 03 87 51 27 28 | lpierre@mirion.com

**Codes:** 17950, 21270, 55040

## NucAdvisor

Courbevoie | www.nucadvisor.com

Bruno Blotas | +33 0 6 28 71 29 08 | bruno.blotas@nucadvisor.com

**Codes:** 14000

## OECD Nuclear Energy Agency (NEA)

Paris | www.oecd-nea.org

NEA Press Office | +33 1 45 24 10 10 | press@oecd-nea.org

**Codes:** 40700, 64315, 73450

## Photonis

See advertisement on page 89

Brive la Gaillarde Cedex | www.exosens.com/nuclear

Ludovic Gonzalez | +33 556 16 72 41 | nuclearsales@exosens.com

**Codes:** 08800, 13400, 17950, 21270, 26910, 28300, 31700, 56400, 56600, 69600

## THERMOCOAX SAS

Caligny | www.thermocoax-nuclear.com

Georges Helleux | +33 1 41 38 80 53 | georges.helleux@thermocoax.com

**Stamps:** NQA-1, 10CFR50 Appendix B, NIAC, RCC-M & RCC-MrX, KTA, YVL

**Codes:** 00400, 03200, 08800, 14950, 15200, 16000, 17950, 21270, 21500, 22150, 30450, 37700, 37800, 40050, 54750, 55490, 56400, 58250, 69600, 70670, 77250, 84150, 85000, 85200, 85700, 86750, 95900

## TRAD - RayXpert

Labège cedex | https://www.rayxpert.com

Antoine Ghilardi | +33 5 61 00 73 81 | antoine.ghilardi@trad.fr

**Codes:** 12750, 12800, 14000, 53950, 60900, 77750, 78400

## Velan S.A.S. (Sub. of Velan Inc. (Canada))

Lyon Cedex 7 | www.velan.com

Raphaël Couturier | +33 4 78 61 67 00 | rcouturier@velan.fr

**Stamps:** RCCM Level 1, 2, 3, NC; NP068-05 (Russia); ASME III Class 1, 2, 3, NC; HAF604 (China), N and NPT stamps.

**Codes:** 90600

## Germany

### Bilfinger Noell GmbH (Dept. BEV)

Wuerzburg | www.bng.bilfinger.com

Dilara Guenenc | +49 9319036214 | dilara.guenenc@bilfinger.com

**Stamps:** Qualification according to DIN ISO 9001, DIN ISO 14001, OHSAS 18001, SCC:2011, KTA 1401.

**Codes:** 03800, 11700, 14300, 14810, 18600, 20300, 20350, 22800, 27150, 30500, 36000, 45700, 47400, 47600, 48050, 58250, 66280, 68000, 72300, 73620, 77700, 77750, 79360, 81710, 83150, 86130, 93040, 95750\*

### ENVINET GmbH

Munich/Haar | www.envinet.com

Wolfgang Rieck | +49 89 45 66 57 0 | info@envinet.com

**Codes:** 12800, 14000, 17950, 21270, 21310, 25250, 26080, 26100, 51730, 55040, 55060, 79850

### GNS Gesellschaft fur Nuklear-Service mbH

Essen | www.gns.de

+49 201 109 0 | info@gns.de

**Codes:** 10780, 12800, 14300, 20300, 20350, 22410, 22700, 68000, 79360, 81710, 87000, 93040

### H. Butting GmbH & Co. KG

Wittingen-Knesebeck | www.butting.com

Felix Kuehn | +49 5834 50 7365 | felix.kuehn@butting.de

Joerg Pollmann | +49 5834 50 486 | joerg.pollmann@butting.de

**Stamps:** ISO 9001, ISO 19443, ASME U-Stamp, AD 2000 W0/HP0, EN ISO 3834, KTA 1401/AVS D 100/50, KTA 3211.1/KTA 3211.3/KTA 1408.3, NADCAP NDT & Welding

**Codes:** 14300, 59800, 59820, 66280, 83150, 87700\*

### Mirion Technologies (MGPI H&B) GmbH (Mirion Technologies)

Munich | www.mirion.com

Ewald Liebhart | +49 8951513114 | eliehart@mirion.com

Markus Knapp | +49 8951513112 | mknapp@mirion.com

**Stamps:** ISO 9001, ISO 19443, 10 CFR 50 App. B, ASME NQA-1, KTA 1401

**Codes:** 03200, 03550, 08400, 08800, 14000, 14950, 17950, 19280, 21270, 21310, 24300, 31700, 51850, 55040, 56400, 63800, 69130, 69600, 74150, 84600, 93040\*

### Siempelkamp NIS

Alzenau | www.siempelkamp-nis.com

John R. Ferrara | 610/906-2997 | john.ferrara@siempelkamp-nis.com

**Stamps:** Quality management according to DIN EN ISO 9001:2015; Quality assurance according to KTA 1401; Occupational safety and health management system - ISO 45001; Security-Safety-Management SeSaM; Authorization to work in third-party plants or facilities; (StrlschV) (German)

**Codes:** 14000, 14300, 20300, 20700, 27450, 53950, 68000, 72300, 79360, 83600, 86130, 86300, 86500, 93040\*



# Directory of Suppliers

## Germany

### vgbe energy service GmbH

Essen | [www.vgbe.services](http://www.vgbe.services)  
Christopher Weßelmann | +49 201 8128 370 | [christopher.wesselmann@vgbe.energy](mailto:christopher.wesselmann@vgbe.energy)  
**Codes:** 03800, 14000, 86300\*

### Walischmiller Engineering GmbH

Markdorf, Baden-Württemberg | [www.hwm.com](http://www.hwm.com)  
Jean-Michel Wagner | +49 7544951480 | [jean-michel.wagner@hwm.com](mailto:jean-michel.wagner@hwm.com)  
**Stamps:** ISO9001:2008, KTA1401, ISO14001, ISO45001, ATEX, SCC  
**Codes:** 07370, 10780, 12800, 47600, 68000, 72300, 73620

## India

### EmmEn Marketing Consultants

Pune, Maharashtra | [emmenindia.co.in](http://emmenindia.co.in)  
Milind Naik | +91 2025453605 | [emmenmktgcons@usa.net](mailto:emmenmktgcons@usa.net)  
**Codes:** 03800, 10010, 11400, 12750, 12800, 14000, 23850, 25400, 26240, 28000, 39960, 64312, 86900

## Italy

### CAEN SyS (CAEN SpA)

Viareggio, LU | [www.caensys.com](http://www.caensys.com)  
Marco Locatelli | 718/981-0401 | [marco@caentech.com](mailto:marco@caentech.com)  
**Codes:** 03200, 03550, 03800, 04000, 06860, 12800, 17950, 19700, 37130, 55040, 63400, 63800, 68000, 69600, 73770\*

### Campoverde srl

Milano | [www.campoverde-group.com](http://www.campoverde-group.com)  
Federico Gianni | +39 0258039052 | +39 335248361 | [federico.gianni@campoverde.it](mailto:federico.gianni@campoverde.it)  
**Codes:** 12800, 14000, 14300, 20700, 67380, 68950, 93040

### Rogante Engineering Office

Civitanova Marche | <https://www.roganteengineering.it>  
Dr. Massimo Rogante | +39 0733775248 | [info@roganteengineering.it](mailto:info@roganteengineering.it)  
**Codes:** 14000, 20300, 40900, 56600, 68900, 84150, 84600

### SIET

Piacenza | [www.siet.it](http://www.siet.it)  
Stefano Botti | +39 0523 329017 | [botti@siet.it](mailto:botti@siet.it)  
Fabrizio Ghizzoni | +39 0523 329048 | [ghizzoni@siet.it](mailto:ghizzoni@siet.it)  
**Stamps:** ISO 9001:2015; EN ISO/IEC 17025:2017 (Testing and Calibration Laboratories); 10CFR50 App. B; 10CFR21; ASME NQA-1-2008 with NQA-1a-2009 Addenda  
**Codes:** 03800, 06860, 09800, 14000, 46200, 47400, 53950, 78400, 80565, 84600

## Korea (The Republic of)

### ANKUG Engineering Co., Ltd.

Seoul | <http://www.ankugenc.com/en/>  
SungMo Lee | +82 10 5284 0389 | [sm.lee@ankugenc.com](mailto:sm.lee@ankugenc.com)  
**Stamps:** ISO 9001, ISO 14001, ISO 45001, ASME U, UL listed, Certificate of registration of KHNP  
**Codes:** 03200, 03800, 28100, 84600, 91260

### BHI CO., LTD.

Haman-gun | [https://www.bhi.co.kr/en\\_index](https://www.bhi.co.kr/en_index)  
Won Kim | +82 55 580 6707 | [wkim@bhi.co.kr](mailto:wkim@bhi.co.kr)  
Injeong Jo | +82 55 580 6255 | [jessica@bhi.co.kr](mailto:jessica@bhi.co.kr)  
**Stamps:** ISO 9001, ISO 14001, ISO 45001, KEPIC (MN, SN), ASME (S, U, U2, PP and NB R), ASME (N, NA, NPT, NS, N3)  
**Codes:** 13200, 38000, 58250, 62300, 77800, 81790\*

### BNF Technology Inc.

Daejeon | <https://www.hanarasoft.com/>  
Junghan Seo | [seojh@bnftech.com](mailto:seojh@bnftech.com)  
**Stamps:** ISO 9001, GS, SP  
**Codes:** 12800

### DAEDONG Metal Industry Co., Ltd.

Busan | <http://www.ddbrg.com/>  
Sungyong, Jang | +82 51 412 2291 | [dmb@ddbrg.com](mailto:dmb@ddbrg.com)  
**Stamps:** ISO 9001, ISO 14001, ISO 45001  
**Codes:** 07100

### E2S Co., Ltd.

Hwaseong-si | <http://www.e2s.co.kr/eng>  
SungSup Kwak | +82 2 488 0586 | [sskwak@e2s.co.kr](mailto:sskwak@e2s.co.kr)  
**Stamps:** ISO9001, ISO14001, ISO45001, CE, KEPIC-EN  
**Codes:** 78400

### Energyen Corporation (Sales Operation)

Gunsan | [www.energyen.co.kr](http://www.energyen.co.kr)  
Harry Lim | +82 63 472 7351 | +82 10 4494 2693 | [harry.lim@energyen.co.kr](mailto:harry.lim@energyen.co.kr)  
**Stamps:** ASME N, N3, NPT, U, U2, S  
**Codes:** 13180, 13200, 14300, 37600, 38000, 77700, 92300\*

### ILSHINEDI Co., Ltd.

Gyeongju-si | <http://www.ilshinedi.com/>  
YoungKi Yoon | +82 31 980 7610 | [yky@ilshinedi.com](mailto:yky@ilshinedi.com)  
**Stamps:** ISO45001, ISO9001, ISO14001, CE (Smart Page Phone), CE (Paging Telephone Handset type ExHS series), IECEx (ExHS Series Paging Telephone Handset)  
**Codes:** 11650

### M&D Co., Ltd.

Seoul | <http://www.e-mnd.com>  
SeongSin Kim | +82 51 723 5031 | [sskim@e-mnd.com](mailto:sskim@e-mnd.com)  
**Stamps:** ISO 9001, KEPIC MN, KOLAS  
**Codes:** 47400, 69600, 72300

### PAVETECH Co., Ltd.

Hwaseong-si | <http://www.pavetech.co.kr/english>  
SeokChan(Steven) Yoo | +82 31 273 5325 | +82 10 3863 3454 | [stargate0609@gmail.com](mailto:stargate0609@gmail.com)  
**Stamps:** ISO 14001, ISO 9001  
**Codes:** 93900

### PK Valve & Engineering Co., Ltd.

Changwon-si | <https://www.pkvalve.co.kr/eng/main.do>  
Jung Joosub | +82 55 268 3751 | [jungjoosub@pkvne.com](mailto:jungjoosub@pkvne.com)  
Kim Donghyun | +82 55 268 3825 | [dhkim@pkvne.com](mailto:dhkim@pkvne.com)  
**Stamps:** ASME-N, NPT, KEPIC MN, ISO 9001/14001/45001 and etc.  
**Codes:** 90600, 91000, 91260





### SUNG IL CO., LTD. (SIM)

Busan | [www.sungilsim.com](http://www.sungilsim.com)

Jin-seok Hwang | +82 51 950 8854 | [hjs06003@sungilsim.com](mailto:hjs06003@sungilsim.com)  
+82 51 831 8800 | [sale1@sungilsim.com](mailto:sale1@sungilsim.com)

**Stamps:** KEPIC MN, ASME S, ASME PP, DVGW (CE), PED Module-H, EN 1090-2, EN ISO 3834, ISO 14001, ISO 45001, Certification of a Qualified Supplier (KOEN, KOSPO, EWP, KOMIPO, WP)

**Codes:** 59850\*

### USERS Corp.

Daejeon | [http://www.users.co.kr/e\\_sub\\_01\\_01.html](http://www.users.co.kr/e_sub_01_01.html)

Junghoon Choi | +82 42 336 4791 | [junghoon@users.co.kr](mailto:junghoon@users.co.kr)

Taegyu Seon | +82 42 336 4788 | [seontg@users.co.kr](mailto:seontg@users.co.kr)

**Codes:** 56400, 78400, 84600\*

### WOORI Technology Inc.

Seoul | [www.wooritg.com](http://www.wooritg.com)

Heung Seop Lee | +82 02 2102 5221 | [ted@wooritg.com](mailto:ted@wooritg.com)

Ji Seon Kim | +82 02 2102 5223 | [jiseon1027@wooritg.com](mailto:jiseon1027@wooritg.com)

**Stamps:** ISO 9001:2015, KEPIC-EN, IRIS(ISO/TS 22163:2017)

**Codes:** 22660\*

### Young Poong Ind.

Busan | <http://www.iyp.co.kr/en/>

Jewan, Kim | +82 51 303 2782 | [sales@iyp.co.kr](mailto:sales@iyp.co.kr)

**Stamps:** ISO45001:2018, KEPIC-MN, etc.

**Codes:** 40900

## Netherlands (The)

### UniTech Services Group Europe (Sub. of UniTech Services Group USA)

Coevorden | [www.unitech-services.eu/](http://www.unitech-services.eu/)

Burkhard Schmitt | +31 524 599 699 | [bschmitt@unitecheu.com](mailto:bschmitt@unitecheu.com)

**Codes:** 10850, 10900, 14300, 20350, 37130, 37160, 37200, 55040, 73550, 93040, 95850

## Poland

### CELSA Huta Ostrowiec (Forge Div.)

Ostrowiec Sw. | [forge.celsa.com](http://forge.celsa.com)

Christophe Gombert | +34 609 170 234 | [cgombert@celsa.com](mailto:cgombert@celsa.com)

**Codes:** 49000, 50350

## South Africa

### Global Network of Companies LLC

Johannesburg | <https://gnconline.net/>

Rick Bosman | [rick@gnconline.net](mailto:rick@gnconline.net)

**Codes:** 03800, 86300, 86400\*

## Spain

### ASVAD INTL SL

Tarragona | <https://www.asvad-nuclear.com/>

[info@asvad-nuclear.com](mailto:info@asvad-nuclear.com)

**Stamps:** Unique owner of the ASVAD patent. Spanish Nuclear Safety Council (CSN) specific approval for using the ASVAD valve in the Spanish NPP's.

**Codes:** 03800, 14000, 70600, 91260\*

### Equipos Nucleares, S.A., S.M.E

Maliaño (Cantabria) | [www.ensa.es](http://www.ensa.es)

Pablo Alvarez | +34 942 200 101 | +34 679 927 304 | [alvarez.pablo@ensa.es](mailto:alvarez.pablo@ensa.es)

Rubén Moreno | +34 942 200 101 | [moreno.ruben@ensa.es](mailto:moreno.ruben@ensa.es)

**Stamps:** N, NPT, S, U, U2, AD-MERKBLATT HPO; ASME Code for Nuclear Vessels, Classes 1, 2 & 3; N, NPT, NA, N3, Certification by ISO 9000, ISO 14001, ISO 3834, EN 17025, OHSAS 18001, ENAC, CEFRI, TUV, IQNET and AENOR, Lloyd's Register LRQA

**Codes:** 03800, 14300, 30600, 56750, 56900, 66280, 68000, 70660, 77700, 80800, 81710, 83150, 93040

### Idom Consulting, Engineering, Architecture S.A.U.

Bilbao | [www.idom.com](http://www.idom.com)

Xabier Ruiz | +34 944797600 | [xabier.ruiz@idom.com](mailto:xabier.ruiz@idom.com)

**Codes:** 03800, 13850, 14000

### Nucleonova S.L.

Valencia | [www.nucleonova.eu](http://www.nucleonova.eu)

Juan Antonio Munoz | +34 961130470 | [nucleonova@nucleonova.es](mailto:nucleonova@nucleonova.es)

**Stamps:** ISO 9001, UNE 73401, 10CFR50 App. B, KTA 1401, ASME NQA-1, ISO 19443

**Codes:** 06860, 12800, 14000, 37200, 66200, 84600, 86300\*

## Sweden

### Brokk AB

Skelleftea | [www.brokk.com](http://www.brokk.com)

Tony Marlow | 505/699-8923 | 505/466-3614 | [tony.marlow@brokkinc.com](mailto:tony.marlow@brokkinc.com)

**Codes:** 10780, 13050, 47600, 68000, 72300, 73620\*

## Switzerland

### Dynatom International GmbH

Bassersdorf | <https://dynatom.org>

Arnaud Lefevre | +41 44 514 27 36 | [alefevre@dynatom.org](mailto:alefevre@dynatom.org)

**Codes:** 06860, 14000, 86300

### LEMO S.A.

Ecublens | [www.lemo.com](http://www.lemo.com)

Cédric Savioz | +41 216951872 | [csavioz@lemo.com](mailto:csavioz@lemo.com)

**Stamps:** Certification by ISO 9001. Sony Green Partner.

**Codes:** 08800, 13400

### Syscom Instruments S.A.

Sainte-Croix | [www.syscom.ch](http://www.syscom.ch)

Dennis Ayden | 314/361-5084 | [ayden@syscominstruments.net](mailto:ayden@syscominstruments.net)

**Codes:** 03200, 03800, 40050, 54750, 76400, 77250, 82950

## Ukraine

### Radics LLC

Kropyvnytskyi | [www.radics.tech](http://www.radics.tech)

Roman Tsaturian | +380 522373328 | [r.tsaturian@radics.tech](mailto:r.tsaturian@radics.tech)

**Stamps:** QAP complies with requirements of 10CFR50 App. B; ASME NQA-1-2008, NQA-1a-2009 Addenda, ISO 9001:2015

**Codes:** 14000, 15200, 19700, 24300, 69600, 76400



# Directory of Suppliers

## United Kingdom

### United Kingdom

#### ATS Industrial Automation, Inc. - Nuclear (UK)

Blaby, Leicester | <https://atsautomation.com/nuclear>  
Narinder Bains | 647328-6848 | [nbains@atsautomation.com](mailto:nbains@atsautomation.com)

**Stamps:** Certifications for Cambridge, Canada facilities: ASME NQA-1; 10CFR50 App. B; 10CFR21 Program; CSA N285.0; CSA N286; CSA N299; CSA B51; ASME B31.1; ASME B31.3; ISO-9001:2015; ISO:13485:2016

**Codes:** 10780, 11700, 12800, 14000, 20300, 25600, 29900, 30040, 30500, 31700, 40900, 43150, 43400, 47400, 47600, 48050, 59850, 68000, 68950, 70650, 72300, 73300, 73620, 79360, 84000, 86130, 86800, 87380, 87400, 87680, 92800, 93040

#### Centronic Ltd.

Surrey | [www.centronic.co.uk](http://www.centronic.co.uk)  
Kate Fairweather | +44 01689 808000 | +44 01689 808018  
[kfairweather@centronic.co.uk](mailto:kfairweather@centronic.co.uk)

**Stamps:** Certification by BS.EN.ISO 9001:2008; CSA-Z-299-2, KTA 1401; DEF STAN 05-91, BS EN ISO 14001:2004.

**Codes:** 01300, 03800, 07200, 08800, 09750, 09800, 10100, 13400, 14000, 14810, 16000, 17950, 18400, 20300, 21270, 21300, 21310, 21400, 24400, 25000, 26080, 26100, 28300, 28400, 28530, 31700, 37130, 41000, 41100, 41200, 41550, 41700, 46950, 47900, 55300, 55500, 55550, 56400, 56460, 56470, 58250, 59800, 59850, 63800, 68800, 68900, 69600, 70650, 73300, 75190, 79350, 79850, 83600, 95900

#### Croft Associates Ltd

Abingdon, Oxfordshire | [www.croftltd.com](http://www.croftltd.com)  
Mark Johnson | +44 0 1865407740 | [mark.johnson@croftltd.com](mailto:mark.johnson@croftltd.com)  
Trevor Tait | +44 0 1865407740 | [trevor.tait@croftltd.com](mailto:trevor.tait@croftltd.com)

**Codes:** 03800, 14000, 14300, 20300, 21400, 68000, 79360, 81680, 81710, 84600, 87000, 93040

#### Cross Manufacturing Co. (1938) Ltd.

Bath | [www.crossmanufacturing.com](http://www.crossmanufacturing.com)  
C. Tozer | +44 0 3301 224 400 | [contact@crossmanufacturing.com](mailto:contact@crossmanufacturing.com)  
**Codes:** 26900, 28400, 49000, 60150, 73590, 75190, 80400, 95900

#### Heatric Division of Meggitt (UK) Ltd.

Poole, Dorset | [www.heatric.com](http://www.heatric.com)  
Stephen Dewson | +44 0 1202 627000 | [stephen.dewson@meggitt.com](mailto:stephen.dewson@meggitt.com)  
**Codes:** 07310, 13200, 14000, 37600, 38000, 47400, 54300, 80800, 80900, 81790, 83150, 92300, 93900

#### Interface Analysis Centre, University of Bristol

Bristol | [www.bris.ac.uk/iac](http://www.bris.ac.uk/iac)  
Dr. Keith R. Hallam | +44 0117 455 6771 | [k.r.hallam@bristol.ac.uk](mailto:k.r.hallam@bristol.ac.uk)  
**Codes:** 03800, 17950

#### KUKA Systems UK Ltd

Halesowen, West Midlands | [www.kuka-systems.co.uk](http://www.kuka-systems.co.uk)  
Dave Burns | +44 7711115816 | [dave.burns@kuka.com](mailto:dave.burns@kuka.com)  
Ian Walker | +44 121 585 0888 | [ian.walker@kuka.com](mailto:ian.walker@kuka.com)  
**Codes:** 10780, 36820, 72300, 73620, 79360, 93040, 93800

#### Nuclear Energy Components Ltd

Hope Valley, Derbyshire | [www.nec-ltd.co.uk](http://www.nec-ltd.co.uk)  
David Greenan | +44 01433 627202 | +44 07990516449 | [david.greenan@nec-ltd.co.uk](mailto:david.greenan@nec-ltd.co.uk)  
**Stamps:** ISO9001, ISO14001, F4N  
**Codes:** 13850, 16000, 30500, 46950, 47400, 47600, 49000, 56600, 66280, 70650, 79000, 86130, 91260, 93750

#### Nuclear Transport Solutions

Warrington | <https://nucleartransportsolutions.com/>  
Michelle Nuttall | [michelle.nuttall@ntsglobal.uk](mailto:michelle.nuttall@ntsglobal.uk)  
Charlotte Davis | [charlotte.davis@ntsglobal.uk](mailto:charlotte.davis@ntsglobal.uk)  
**Codes:** 87000\*

#### Prospect Law Ltd.

London | [www.prospectlaw.co.uk](http://www.prospectlaw.co.uk)  
Edward de la Billiere | +44 020 7947 5354 | [edlb@prospectlaw.co.uk](mailto:edlb@prospectlaw.co.uk)  
**Codes:** 14000, 45280, 73450, 86300, 87000

#### Siteflow

London | [www.siteflow.com](http://www.siteflow.com)  
Louis Hauvette | +33 6 66 73 72 90 | [louis.hauvette@siteflow.com](mailto:louis.hauvette@siteflow.com)  
Sid Bains | +44 7961 584628 | +44 1925 877000 | [sid.bains@siteflow.com](mailto:sid.bains@siteflow.com)  
**Stamps:** ISO 27001, ISO 9001:2015  
**Codes:** 12800

#### University of Bristol (Interface Analysis Centre) (South West Nuclear Hub)

Bristol | [www.southwestnuclearhub.ac.uk](http://www.southwestnuclearhub.ac.uk)  
[enquiries@southwestnuclearhub.ac.uk](mailto:enquiries@southwestnuclearhub.ac.uk)  
**Codes:** 03800, 12720, 12800, 14000, 17950, 26230, 56600, 72300, 73450, 76400, 84600, 86300, 93040



# Solutions for radiological safety



## **PROJECT MANAGEMENT**

Safely solving high-risk radiological challenges



## **RADIOLOGICAL SERVICES**

Supporting the industry for over 30 years



## **DECOMMISSIONING**

Extensive knowledge of government, industrial, and nuclear sites

# Think Collaboration. Think Innovation. Think Paragon.



**Committed to supporting a zero-carbon energy future.**

Paragon, a forward-thinking collaborative partner, works to develop innovative solutions for the nuclear industry that are safer, more reliable, and more cost-efficient.



1-817-284-0077 | [www.ParagonES.com](http://www.ParagonES.com)

